ELECTRICAL CIRCUIT DIAGRAM MANUAL

Electrical Circuit Diagrams

TerraStar®

Navistar, Inc.

2701 Navistar Drive, Lisle, IL 60532 USA

TABLE OF CONTENTS

2. INSTRUCTIONS AND CHARTS (CHAPTER 2)	1
2.1. ABBREVIATIONS, P. 1.....	1
2.2. ACRONYMS, P. 2.....	2
2.3. CIRCUIT DIAGRAM INSTRUCTIONS, P. 3.....	3
2.4. CIRCUIT NUMBER IDENTIFICATION AND COLOR, P. 4.....	4
2.5. CIRCUIT NUMBER IDENTIFICATION AND COLOR (CONT.), P. 5.....	5
2.6. CIRCUIT NUMBER IDENTIFICATION AND COLOR (CONT.), P. 6.....	6
2.7. LAMP BULB CHART, P. 7.....	7
2.8. RELAY FUNCTION AND WIRING DIAGRAM, P. 8.....	8
2.9. SCHEMATIC SYMBOL CHART, P. 9.....	9
2.10. SCHEMATIC SYMBOL CHART (CONT.), P. 10.....	10
2.11. SCHEMATIC SYMBOL CHART (CONT.), P. 11.....	11
2.12. SCHEMATIC SYMBOL CHART (CONT.), P. 12.....	12
3. 12 VOLT POWER DISTRIBUTION, GROUNDS, DATA BUS AND ELECTRICAL SYSTEM CONTROLLER (CHAPTER 3)	13
3.1. BATTERY FEED, DUAL, P. 1.....	13
3.2. IGNITION FEED – STANDARD, THEFT DETERRENT, REMOTE START / STOP, P. 2.....	14
3.3. J708 DATA LINK – PUBLIC EFFECTS, P. 3.....	15
3.4. J1708 DATA LINK – PRIVATE WITH POWER WINDOW AND LOCK, P. 4.....	16
3.5. J1939 DATA LINK, P. 5.....	17
3.6. GROUND – IP, P. 6.....	18
3.7. ZERO VOLT REFERENCE, P. 7.....	19
3.8. BATTERY FEED, SINGLE, P. 8.....	20
3.9. J1939 DATA LINK – V8 ENGINE, P. 9.....	21
3.10. J1939 DATA LINK – V8 ENGINE WITH ALLISON WTEC, P. 9A.....	22
3.11. J1939 DATA LINK – V8 ENGINE WITH ALLISON LCT WITH IN-CAB TCM, P. 9B.....	23
3.12. ACCESSORY FEED, P. 10.....	24
3.13. J1939 DATA LINK – WITH OPTIONS, P. 11.....	25
3.14. IGNITION FEED – RELAY 1, P. 12.....	26
3.15. INTENTIONALLY LEFT BLANK, P. 13.....	27
3.16. IGNITION FEED – RELAY 3, P. 14.....	28
3.17. BATTERY FEED, DUAL, P. 15.....	29
3.18. BATTERY FEED, DUAL (CONT.), P. 16.....	30
3.19. BATTERY FEED, SINGLE, P. 17.....	31
3.20. INTENTIONALLY LEFT BLANK, P. 18.....	32
3.21. GROUND – SEAT AND SEAT BELT SENSOR, P. 19.....	33
3.22. GROUND – IP, P. 20.....	34
3.23. GROUND – IP (CONT.), P. 21.....	35
3.24. GROUND – IP (CONT.), P. 22.....	36
3.25. GROUND – CHASSIS, P. 23.....	37
3.26. GROUND – IP, P. 24.....	38
3.27. GROUND – IP (CONT.), P. 25.....	39
3.28. GROUND – CHASSIS, P. 26.....	40
3.29. INTENTIONALLY LEFT BLANK, P. 27.....	41
3.30. GROUND – TRAILER SOCKET AND FUEL PUMP, P. 28.....	42
4. CAB ACCESSORIES (CHAPTER 4)	43
4.1. CIGAR LIGHTER AND POWER FEED, P. 1.....	43
4.2. CIGAR LIGHTER AND POWER FEED (CONT.), P. 2.....	44
4.3. COMPASS DISPLAY, P. 3.....	45

TABLE OF CONTENTS (CONT.)

4.4.	FRONT DOOR WINDOWS AND LOCKS (POWER), P. 4.....	46
4.5.	FRONT DOOR WINDOWS AND LOCKS (POWER) FOR CREW, P. 5.....	47
4.6.	HORN – ELECTRIC AND AIR, P. 6.....	48
4.7.	MIRRORS (HEATED, LIGHTED & POWER), P. 7.....	49
4.8.	2 – WAY RADIO, P. 8.....	50
4.9.	INTENTIONALLY LEFT BLANK, P. 9.....	51
4.10.	SELF CONTAINED AIR SEAT, P. 10.....	52
4.11.	RADIO (ENTERTAINMENT) SPEAKERS – WITH 16 WAY CONNECTOR, P. 11.....	53
4.12.	RADIO (ENTERTAINMENT) SPEAKERS – WITH 12 WAY CONNECTOR, P. 11A.....	54
4.13.	RADIO (ENTERTAINMENT), SPEAKERS – WITH 16 WAY CONNECTOR (CONT.), P. 12.....	55
4.14.	INTENTIONALLY LEFT BLANK, P. 13.....	56
4.15.	INTENTIONALLY LEFT BLANK, P. 14.....	57
4.16.	INTENTIONALLY LEFT BLANK, P. 15.....	58
4.17.	INTENTIONALLY LEFT BLANK, P. 16.....	59
4.18.	ROOF AUX LOAD, P. 17.....	60
4.19.	INTENTIONALLY LEFT BLANK, P. 18.....	61
4.20.	INTENTIONALLY LEFT BLANK, P. 19.....	62
4.21.	INTENTIONALLY LEFT BLANK, P. 20.....	63
4.22.	MIRRORS (HEATED, LIGHTED & POWER) , P. 21.....	64
4.23.	CB POWER RADIO, P. 22.....	65
4.24.	BACK-UP CAMERA, P. 23.....	66
4.25.	HEATED SEATS, P. 24.....	67
4.26.	SWITCH PACK OPTIONAL GAUGE PACK, P. 25.....	68
4.27.	WINDSHIELD WIPER, P. 26.....	69
4.28.	SEAT BELT AND SEAT SENSOR, P. 27.....	70
4.29.	SEAT BELT AND SEAT SENSOR (CONT.), P. 28.....	71
4.30.	SEAT BELT AND SEAT SENSOR (CONT.), P. 29.....	72
4.31.	SEAT BELT AND SEAT SENSOR (CONT.), P. 30.....	73
5.	12V CHARGING AND CRANKING SYSTEM (CHAPTER 5).....	74
5.1.	STARTING AND CRANKING ENGINE WITH ALLISON TRANSMISSION, P. 1.....	74
5.2.	ROCKER START, P. 2.....	75
6.	FANS AND ENGINE ACCESSORIES (CHAPTER 6).....	76
6.1.	FAN WIRING – V8 ENGINE, P. 1.....	76
6.2.	SNOW VALVE, P. 2.....	77
7.	ELECTRONIC ENGINES (CHAPTER 7).....	78
7.1.	ELECTRONIC ENGINE CONTROLS – V8 ENGINE, P. 1.....	78
7.2.	ELECTRONIC ENGINE CONTROLS – V8 ENGINE (CONT.), P. 2.....	79
7.3.	ELECTRONIC ENGINE CONTROLS – V8 ENGINE (CONT.), P. 3.....	80
7.4.	ELECTRONIC ENGINE CONTROLS – V8 ENGINE (CONT.), P. 3.....	81
7.5.	ELECTRONIC ENGINE CONTROLS – V8 ENGINE (CONT.), P. 4.....	82
7.6.	ELECTRONIC ENGINE CONTROLS – V8 ENGINE CRUISE CONTROLS, P. 5.....	83
8.	GAUGES WITH AND WITHOUT INTERNAL WARNING LIGHT (CHAPTER 8).....	84
8.1.	BRAKE SWITCH AND PARK BRAKE SWITCH, P. 1.....	84
8.2.	GAUGES AND WARNING LIGHTS – AMMETER, P. 2.....	85
8.3.	INTENTIONALLY LEFT BLANK, P. 3.....	86
8.4.	AIR PRESSURE INPUT CIRCUIT, P. 4.....	87
8.5.	IP GAUGES AND WARNING LIGHTS – GAUGE CLUSTER, P. 5.....	88

TABLE OF CONTENTS (CONT.)

8.6.	IP / GAUGES, P. 6.....	89
8.7.	WARNING LIGHTS LIST, P. 7.....	90
8.8.	WARNING LIGHTS CONTROLLING BY ENGINE, TRANSMISSION, ABS CONTROLLER, P. 8.....	91
8.9.	ENGINE OIL PRESS & TEMP, SPEEDOMETER, TACH, VOLTMETER & WATER TEMP GAUGE CIRCUITS, P. 9.....	92
8.10.	FUEL GAUGE CIRCUITRY (SINGLE TANK AND DUAL TANK), P. 10.....	93
9.	LIGHTS (CHAPTER 9).....	94
9.1.	BACK-UP – WITH ALLISON TRANSMISSION, P. 1.....	94
9.2.	LIGHT SYSTEM – CLEARANCE, MARKER, PARK, TAIL, TURN & STOP LIGHTS, P. 2.....	95
9.3.	LIGHT SYSTEM – CLEARANCE, MARKER, PARK, TAIL, TURN & STOP LIGHTS (CONT.), P. 3.....	96
9.4.	LIGHT SYSTEM, FOG LIGHT, P. 4.....	97
9.5.	HEADLIGHTS, P. 5.....	98
9.6.	PANEL LIGHTS, P. 6.....	99
9.7.	INTENTIONALLY LEFT BLANK, P. 7.....	100
9.8.	LIGHT SYSTEM – CLEARANCE, MARKER, PARK, TAIL, TURN & STOP LIGHTS (CONT.), P. 8.....	101
9.9.	LIGHT SYSTEM – CLEARANCE, MARKER, PARK, TAIL, TURN & STOP LIGHTS (CONT.), P. 9.....	102
9.10.	AUX HEADLIGHTS, SNOWPLOW LIGHTS, P. 10.....	103
9.11.	AUX HEADLIGHTS, SNOWPLOW LIGHTS (CONT.), P. 11.....	104
9.12.	DOME LIGHT SYSTEM, P. 12.....	105
9.13.	CLEARANCE AND MARKER LIGHT, P. 13.....	106
10.	CHASSIS ACCESSORIES (CHAPTER 10).....	107
10.1.	TRW ABS BRAKES, P. 1.....	107
10.2.	TRW ABS BRAKES (CONT.), P. 2.....	108
10.3.	TRW ABS BRAKES (CONT.), P. 3.....	109
10.4.	BODY BUILDER AND TRAILER – TURN, MARKERS AND STOP , P. 4.....	110
10.5.	BODY BUILDER AND TRAILER – TURN, MARKERS AND STOP (CONT.), P. 5.....	111
10.6.	BODY BUILDER ACC FEED WIRING, P. 6.....	112
10.7.	BODY BUILDER CONNECTIONS, P. 7.....	113
10.8.	INTENTIONALLY LEFT BLANK, P. 8.....	114
10.9.	REMOTE POWER MODULE – CAB MOUNTED, P. 9.....	115
10.10.	REMOTE POWER MODULE – CAB MOUNTED (CONT.), P. 9A.....	116
10.11.	FUEL / HEATER RELAY, P. 10.....	117
10.12.	ELECTRIC TRAILER BRAKE, P. 11.....	118
10.13.	HOOR METER – PTO, P. 12.....	119
10.14.	AIR DRYER AND HEATED DRAIN VALVE, P. 13.....	120
10.15.	REMOTE START / STOP, P. 14.....	121
10.16.	INTENTIONALLY LEFT BLANK, P. 15.....	122
10.17.	WHEELCHAIR LIFT INTERLOCK, P. 16.....	123
10.18.	WHEELCHAIR LIFT INTERLOCK (CONT.), P. 16A.....	124
10.19.	AUX INPUTS AND DRIVERS, P. 17.....	125
10.20.	AUX AND POWER SOURCE, P. 17A.....	126
10.21.	TRANSFER CASE EFFECTS, P. 18.....	127
10.22.	FUEL TRANSFER PUMP, P. 19.....	128
10.23.	TRAILER SOCKET – EOF, P. 20.....	129
10.24.	BODY BUILDER & TRAILER SOCKET – BOC & EOF, P. 21.....	130

TABLE OF CONTENTS (CONT.)

10.25. AUX TRAILER CIRCUIT, P. 22.....	131
10.26. TRANSFER CASE EFFECTS WITH CONTROLS FOR ONE LIFT AXLE, P. 23.....	132
10.27. INTENTIONALLY LEFT BLANK, P. 24.....	133
10.28. INTENTIONALLY LEFT BLANK, P. 25.....	134
10.29. INTENTIONALLY LEFT BLANK, P. 26.....	135
10.30. AIR HORN, P. 27.....	136
10.31. AIR SOLENOID 4-PACK, P. 28.....	137
10.32. AIR SOLENOID 8-PACK, P. 29.....	138
11. TRANSMISSION (CHAPTER 11).....	139
11.1. ALLISON GEN 4 1/2000 TRANSMISSION, P. 1.....	139
11.2. ALLISON GEN 4 1/2000 TRANSMISSION (CONT.), P. 2.....	140
11.3. ALLISON GEN 1/2000 TRANSMISSION, P. 3.....	141
11.4. TRANSMISSION ALLISON MD (WTEC), P. 4.....	142
11.5. ALLISON TRANSMISSION 1/2000 WITH IN-CAB TCM, P. 5.....	143
11.6. SHIFTER INTERLOCK EFFECTS, P. 6.....	144
11.7. SHIFTER INTERLOCK EFFECT (CONT.), P. 7.....	145
11.8. ALLISON WTEC TRANSMISSION GEN 8, P. 8.....	146
11.9. WTEC GEN 4 TRANSMISSION, P. 9.....	147
11.10. WTEC GEN 4 TRANSMISSION (CONT.), P. 10.....	148
11.11. TRANSMISSION RETARDER CONTROLS WIRING WITH MD TRANSMISSION HARD WIRED EFFECTS, P. 11.....	149
12. AIR CONDITIONING (CHAPTER 12).....	150
12.1. HVAC SYSTEM, P. 1.....	150
12.2. HVAC SYSTEM (CONT.), P. 2.....	151
12.3. AIR CONDITIONING, P. 3.....	152
12.4. AIR CONDITIONING (CONT.), P. 4.....	153
13. CONNECTOR BODY COMPOSITES (CHAPTER 13).....	154
13.1. CONNECTOR BODY COMPOSITES (71 / 72 / 254F / 254M / 400), P. 1.....	154
13.2. CONNECTOR BODY COMPOSITES (421 / 422 / 422F / 423), P. 2.....	155
13.3. CONNECTOR BODY COMPOSITES (424 / 828 / 1008FA), P. 2A.....	156
13.4. CONNECTOR BODY COMPOSITES (1010), P. 3.....	157
13.5. CONNECTOR BODY COMPOSITES (1011), P. 4.....	158
13.6. CONNECTOR BODY COMPOSITES (1012), P. 5.....	159
13.7. CONNECTOR BODY COMPOSITES (1013), P. 6.....	160
13.8. CONNECTOR BODY COMPOSITES (1014), P. 7.....	161
13.9. CONNECTOR BODY COMPOSITES (1015), P. 8.....	162
13.10. CONNECTOR BODY COMPOSITES (1016), P. 9.....	163
13.11. CONNECTOR BODY COMPOSITES (1017), P. 10.....	164
13.12. CONNECTOR BODY COMPOSITES (1018), P. 11.....	165
13.13. CONNECTOR BODY COMPOSITES (1019), P. 12.....	166
13.14. CONNECTOR BODY COMPOSITES (1020), P. 13.....	167
13.15. CONNECTOR BODY COMPOSITES (1025 / 1026), P. 14.....	168
13.16. CONNECTOR BODY COMPOSITES (1100 / 1100MA / 1101 / 1101A), P. 15.....	169
13.17. CONNECTOR BODY COMPOSITES (1106 / 1107), P. 16.....	170
13.18. CONNECTOR BODY COMPOSITES (1110 / 1200 / 1210 / 1220), P. 17.....	171
13.19. CONNECTOR BODY COMPOSITES (1300 / 1301 / 1500 / 1501), P. 18.....	172
13.20. CONNECTOR BODY COMPOSITES (1501 / 1502 / 1503), P. 18A.....	173
13.21. CONNECTOR BODY COMPOSITES (1512 / 1600), P. 19.....	174

TABLE OF CONTENTS (CONT.)

13.22. CONNECTOR BODY COMPOSITES (1601), P. 20.....	175
13.23. CONNECTOR BODY COMPOSITES (1602), P. 21.....	176
13.24. CONNECTOR BODY COMPOSITES (1603 / 1604 / 1623 / 1625), P. 22.....	177
13.25. CONNECTOR BODY COMPOSITES (1626 / 1657 / 1650 / 1660 / 1661), P. 23.....	178
13.26. CONNECTOR BODY COMPOSITES (1700), P. 24.....	179
13.27. CONNECTOR BODY COMPOSITES (1700), P. 25.....	180
13.28. CONNECTOR BODY COMPOSITES (1700), P. 26.....	181
13.29. CONNECTOR BODY COMPOSITES (1700), P. 27.....	182
13.30. CONNECTOR BODY COMPOSITES (1701), P. 28.....	183
13.31. CONNECTOR BODY COMPOSITES (1701), P. 29.....	184
13.32. CONNECTOR BODY COMPOSITES (1701F), P. 30.....	185
13.33. CONNECTOR BODY COMPOSITES (1701F), P. 31.....	186
13.34. CONNECTOR BODY COMPOSITES (1702), P. 32.....	187
13.35. CONNECTOR BODY COMPOSITES (1702), P. 33.....	188
13.36. CONNECTOR BODY COMPOSITES (1800 / 1800F), P. 34.....	189
13.37. CONNECTOR BODY COMPOSITES (1800FA / 1804 / 1807 / 1809 / 1810), P. 35.....	190
13.38. CONNECTOR BODY COMPOSITES (1814A / 1814B / 1815 / 1815A / 1828 / 1861 / 1872 / 1873), P. 36.....	191
13.39. CONNECTOR BODY COMPOSITES (1873W / 1873X / 1873Y / 1873Z / 1900 / 1936M), P. 36A.....	192
13.40. CONNECTOR BODY COMPOSITES (1901 / 1912 / 1918 / 1927 / 1929 / 1935), P. 37.....	193
13.41. CONNECTOR BODY COMPOSITES (2000 / 2000F / 2002M / 2003M / 2004M / 2005M), P. 37A.....	194
13.42. CONNECTOR BODY COMPOSITES (2006M / 2115M / 2116F / 2117F / 2021 / 2301M), P. 37B.....	195
13.43. CONNECTOR BODY COMPOSITES (2302M / 2304M / 2305M / 2502M), P. 37C.....	196
13.44. CONNECTOR BODY COMPOSITES (2503 / 2600 / 2601M / 2602M), P. 38.....	197
13.45. CONNECTOR BODY COMPOSITES (3000 / 3001 / 3003 / 3100M / 3200), P. 39.....	198
13.46. CONNECTOR BODY COMPOSITES (3201M / 3202M / 3203M / 3205M / 3206 / 3209M), P. 39A.....	199
13.47. CONNECTOR BODY COMPOSITES (3204 / 4000 / 4001 / 4004 / 4031 / 4032), P. 40.....	200
13.48. CONNECTOR BODY COMPOSITES (4033 / 4040 / 4041 / 4060 / 4087), P. 40A.....	201
13.49. CONNECTOR BODY COMPOSITES (4410A / 4410B / 4410D / 4411F / 4411M / 4412F), P. 40B.....	202
13.50. CONNECTOR BODY COMPOSITES (4412F1 / 4450AM / 4450BM / 4450M / 4060), P. 41....	203
13.51. CONNECTOR BODY COMPOSITES (4460AM / 4460BF / 4460BM / 4450BF / 4460M / 4500 / 4906), P. 42.....	204
13.52. CONNECTOR BODY COMPOSITES (6011 / 6020M), P. 43.....	205
13.53. CONNECTOR BODY COMPOSITES (6020M), P. 44.....	206
13.54. CONNECTOR BODY COMPOSITES (6022 / 6022A / 6200 / 6260HL / 6620HR / 6620T / 6260UC / 6260T / 6261 / 6261T / 6261NV), P. 45.....	207
13.55. CONNECTOR BODY COMPOSITES (6262 / 6262NV / 6262T / 6263 / 6263NV / 6263T / 6322), P. 45A.....	208
13.56. CONNECTOR BODY COMPOSITES (6333 / 6334 / 6400 / 6405 / 6561 / 6704M), P. 46.....	209
13.57. CONNECTOR BODY COMPOSITES (6747 / 6900 / 7100 / 7103M), P. 47.....	210
13.58. CONNECTOR BODY COMPOSITES (7150), P. 47A.....	211
13.59. CONNECTOR BODY COMPOSITES (7150), P. 47B.....	212
13.60. CONNECTOR BODY COMPOSITES (7151), P. 48.....	213
13.61. CONNECTOR BODY COMPOSITES (7205F / 7206F / 7207M / 7207MA), P. 49.....	214
13.62. CONNECTOR BODY COMPOSITES (7208M / 7208A / 7250M / 7350 / 7500M / 7600M), P. 49A.....	215

TABLE OF CONTENTS (CONT.)

13.63. CONNECTOR BODY COMPOSITES (7601M / 7603M / 7604M / 7605M / 7607M / 7611 / 7700M / 7710), P. 50..... 216

13.64. CONNECTOR BODY COMPOSITES (7711 / 7801M / 8000 / 8001), P. 50A..... 217

13.65. CONNECTOR BODY COMPOSITES (8102 / 8150 / 8151 / 8200 / 8201 / 8301), P. 51..... 218

13.66. CONNECTOR BODY COMPOSITES (8502 / 8503 / 8505A / 8600 / 8602 / 8800), P. 52..... 219

13.67. CONNECTOR BODY COMPOSITES (8805 / 8807 / 8881 / 8882), P. 53..... 220

13.68. CONNECTOR BODY COMPOSITES (8883 / 8884A / 8884C), P. 53A..... 221

13.69. CONNECTOR BODY COMPOSITES (8995 / 8996), P. 53B..... 222

13.70. CONNECTOR BODY COMPOSITES (8997 / 8998 / 8999 / 9001), P. 54..... 223

13.71. CONNECTOR BODY COMPOSITES (9100 / 9101 / 9101A / 9102 / 9260 / 9261), P. 55..... 224

13.72. CONNECTOR BODY COMPOSITES (9511A / 9521 / 9522 / 9530), P. 56..... 225

13.73. CONNECTOR BODY COMPOSITES (9715 / 9715F / 9716 / 9716M / 9717), P. 57..... 226

13.74. CONNECTOR BODY COMPOSITES (9717 / 9717F / 9736 / 9737 / 9740), P. 58..... 227

13.75. CONNECTOR BODY COMPOSITES (9778 / 9778F / 9779F / 9780M), P. 58A..... 228

13.76. CONNECTOR BODY COMPOSITES (9745 / 9746 / 9800), P. 59..... 229

13.77. CONNECTOR BODY COMPOSITES (9812 / 9900 / 9913B / 9915), P. 60..... 230

13.78. CONNECTOR BODY COMPOSITES (9916 / 9930 / 9994), P. 60A..... 231

INSTRUCTIONS AND CHARTS (CHAPTER 2)

2.1. ABBREVIATIONS, P. 1

NAVISTAR, INC				ELECTRICAL CIRCUIT DIAGRAM CHAPTER 2	
THIS PRINT IS PROVIDED ON A RESTRICTED BASIS AND IS NOT TO BE USED IN ANY WAY DETRIMENTAL TO THE INTEREST OF NAVISTAR, INC.				ABBREVIATIONS	
ABBREVIATION	DESCRIPTION	ABBREVIATION	DESCRIPTION	ABBREVIATION	DESCRIPTION
ACCESS	ACCESSORY	CRUS	CRUISE	FWR	POWER
ACCUM	ACCUMULATOR	CUR	CURRENT	PRESS	PRESSURE
AC	AIR CONDITIONING	DPNL	DASHBOARD	RAD	RADIO
AIR CLNR	AIR CLEANER	DFTR	DEFLECTOR	RR	REAR
ALT	ALTERNATOR	DFR	DEFROSTER	RLY	RELAY
ACCEL	ACCELERATOR	DEG	DEGREE	RES	RESISTOR
AC	ALTERNATING CURRENT	DIAG	DIAGRAM	REGEN	REGENERATE
AFTR	AFTERTREATMENT	DSL	DIESEL	R	RIGHT
AMM	AMMETER	DIFF	DIFFERENTIAL	RTR	ROTOR
AMP	AMPERE	DIMR	DIMMER	SNSR	SENSOR
AMP HR	AMPERE HOUR	ELEC	ELECTRICAL	SHLD	SHIELD
AMPL	AMPLIFIER	ELEX	ELECTRONICS	SHFT	SHIFTER
ARM	ARMATURE	ENG	ENGINE	SLPR	SLEEPER
ARBR	ARRESTER	EXH	EXHAUST	SLV	SLEEVE
ASSY	ASSEMBLY	FL	FLUID	SPKR	SPEAKER
AUX	AUXILIARY	FWD	FORWARD	SPR	SPRING
B/U	BACK-UP	FR	FRONT	STD	STANDARD
BTRY	BATTERY	FREQ	FREQUENCY	STRG	STEERING
BM	BENCHMARKING	GA	GAUGE	STLITE	SATELLITE
BLK	BLOCK	GEN	GENERATOR	SUNSH	SUNSHADE
BOOS	BOOSTER	GND	GROUND	SW	SWITCH
BOT	BOTTOM	HARN	HARNESS	SYS	SYSTEM
BK	BRAKE	HDLP	HEADLAMP	TACH	TACHOMETER
BRKR	BREAKER	HTD	HEATED	TEMP	TEMPERATURE
BRTHR	BREATHER	HT TR	HEAT TREAT	TERM	TERMINAL
BRT	BRIGHT	HTR	HEATER	THROT	THROTTLE
BUZ	BUZZER	HP	HORSEPOWER	THRU	THROUGH
CA	CABLE	HYD	HYDRAULIC	TRAC	TRACTION
CD	CANDELA	ID	IDENTIFICATION	TRLR	TRAILER
CP	CANDLEPOWER	IGN	IGNITION	XDCR	TRANSducer
CAP	CAPACITOR	ILLUM	ILLUMINATION	XFER	TRANSFER
CAT	CATERPILLAR	IND	INDICATOR	XFMR	TRANSFORMER
CHAS	CHASSIS	INST	INSTRUMENT	XSTR	TRANSISTOR
CH	CHOKE	INT	INTERMITTENT	XMSN	TRANSMISSION
CTRC	CIRCUIT	L	LEFT	XMTR	TRANSMITTER
CLK	CLOCK	LT	LIGHT	TRK	TRUCK
CW	CLOCKWISE	LTR	LIGHTER	UPR	UPPER
CLSTR	CLUSTER	LWR	LOWER	VLV	VALVE
CL	CLUTCH	MAG	MAGNET	VERT	VERTICAL
COL	COLUMN	MOD	MODULATOR	VM	VOLTMETER
COMM	COMMUTATOR	MDL	MODULE	VOL	VOLUME
COMPNT	COMPONENT	MOT	MOTOR	WSHR	WASHER
CPRSSR	COMPRESSOR	MTD	MOUNTED	WHL	WHEEL
CONN	CONNECTOR	NEG	NEGATIVE	WDO	WINDOW
CONT	CONTINUED	N/	NOT WITH	WSHLD	WINDSHIELD
CSL	CONSOLE	NO.	NUMBER	WPR	WIPER
CONT	CONTACT	PASS	PASSENGER	W/	WITH
CONT	CONTROL	POSN	POSITION	W/O	WITHOUT
CONV	CONVERTER	POS	POSITIVE		
CLR	COOLER	POT	POTENTIOMETER		
CTSY	COURTESY				

CHR	DATE	CHANGE	REV	REFERENCE	DRAWN	NAME
CNA1	11NOV10	INITIAL RELEASE.	A	67696A	U01A133	CIRCUIT DIAGRAM, TERRASTAR
					RELEASE NO.	DATE
					67696A	04AUG10
					PART NO.	SHEET
					AE08064593	001

Figure 1 Abbreviations

ELECTRICAL CIRCUIT DIAGRAM MANUAL

2.2. ACRONYMS, P. 2

NAVISTAR, INC				ELECTRICAL CIRCUIT DIAGRAM CHAPTER 2			
THIS PRINT IS PROVIDED ON A RESTRICTED BASIS AND IS NOT TO BE USED IN ANY WAY DETRIMENTAL TO THE INTEREST OF NAVISTAR, INC.				ACRONYMS			
DESCRIPTION				ACRONYM			
ANTILOCK BRAKING SYSTEM				ABS			
ANTENNA COMMUNICATION UNIT				ACU			
ALTERNATING CURRENT				AC			
AXLE TO BACK OF CAB				AC			
AXLE TO FRAME				AF			
ACCELERATOR PEDAL MODULE				APM			
ACCELERATOR POSITION SENSOR				APS			
AUXILIARY POWER UNIT				APU			
AMERICAN TRUCKING ASSOCIATION				ATA			
AUTOMATIC TRACTION CONTROL				ATC			
AUDIO VIDEO INTERFACE				AVI			
BAROMETRIC ATMOSPHERE PRESSURE				BAP			
BRAKE HORSEPOWER				BHP			
BACK OF CAB				BOC			
CITIZEN BAND				CB			
COLD CRANKING AMPERES				CCA			
CLEAN POWER ELECTRICAL CONNECTOR				CEC			
CENTRAL PROCESSING UNIT				CPU			
CAB OVER ENGINE				COE			
DIRECT CURRENT				DC			
DRIVER CONTROL MODULE				DCM			
DIGITAL DATA LINK				DDL			
DIESEL OXIDATION CATALYST INLET TEMPERATURE				DOCT			
DIESEL PARTICULATE FILTER				DPF			
DIESEL PARTICULATE FILTER DELTA PRESSURE				DPFDP			
DIESEL PARTICULATE FILTER TEMPERATURE				DPFT			
DIESEL TURBOCHARGED				DT			
DAY TIME RUNNING LIGHTS				DTRL			
ELECTRONIC CONTROL MODULE				ECM			
ELECTRONIC CONTROL UNIT				ECU			
EXHAUST GAS RECIRCULATION				EGR			
EXHAUST GAS TEMPERATURE				EGT			
ELECTRO MAGNETIC INTERFERENCE				EMI			
END OF FRAME				EOF			
ELECTRIC TRAILER BRAKE				ETB			
FRONT AXLE				FA			
FRONT END				FE			
FRONT OF DASH				FOD			
FULL POWER BRAKE				FPB			
GLOBAL POSITIONING SYSTEM				GPS			
HYDRAULIC CONTROL UNIT				HCU			
HEAVY DUTY				HD			
DESCRIPTION				ACRONYM			
HEAVY DUTY DIESEL				HDD			
HIGH PERFORMANCE TRUCK				HPT			
HEATING, VENTILATION, AND AIR CONDITIONING				HVAC			
INJECTOR DRIVE MODULE				IDM			
INPUT/OUTPUT				I/O			
INTEGRATED MOBILE COMMUNICATION TERMINAL				IMCT			
INSTRUMENT PANEL				I/P			
INDEPENDENT POWER TAKE-OFF				IPTO			
INTERNATIONAL BIG BORE ENGINE				IBBE			
LIGHT COMMERCIAL TRANSMISSION				LCT			
LOW PRESSURE MODULE				LPM			
MEDIUM DUTY				MD			
MALFUNCTION INDICATION LAMP				MIL			
MULTIPLEX SWITCH MODULE				MSM			
PYROMETER AMMETER MODULE				PAM			
POWER DISTRIBUTION CENTER				PDC			
PROGRAMMABLE LOGIC CONTROLLER				PLC			
POWER TAKE-OFF				PTO			
PULSE WIDTH MODULATION				PWM			
REAR AXLE				RA			
RADIO FREQUENCY				RF			
ROLL STABILITY PROGRAM				RSP			
SEVERE SERVICE				SS			
TRANSMISSION CONTROL MODULE				TCM			
TERRESTRIAL COMMUNICATION UNIT				TCU			
TERRESTRIAL MOBILE COMMUNICATION TERMINAL				TMCT			
THERMAL OVERCRANK PROTECTION				TOCP			
THROTTLE POSITION SENSOR				TPS			
WORLD TRANSMISSION ELECTRONIC CONTROLS				WTEC			
VEHICLE SPEED OUTPUT				VSO			
VEHICLE SPEED SENSOR				VSS			
ZERO VOLT REFERENCE				ZVR			
VEHICLE SPEED OUTPUT				VSO			
VEHICLE SPEED SENSOR				VSS			
ZERO VOLT REFERENCE				ZVR			

CHK	DATE	CHANGE	REV	REFERENCE	DRAWN	NAME
CNA1	11NOV10	INITIAL RELEASE.	A	67696A	U01A133	CIRCUIT DIAGRAM, TERRASTAR
					RELEASE NO.	DATE
					67696A	04AUG10
					PART NO.	SHEET
					AE08064593	002

Figure 2 Acronyms

2.3. CIRCUIT DIAGRAM INSTRUCTIONS, P. 3

<p>NAVISTAR, INC</p> <p>THIS PRINT IS PROVIDED ON A RESTRICTED BASIS AND IS NOT TO BE USED IN ANY WAY DETRIMENTAL TO THE INTEREST OF NAVISTAR, INC.</p>		<p>ELECTRICAL CIRCUIT DIAGRAM CHAPTER 2</p> <p>CIRCUIT DIAGRAM INSTRUCTIONS</p>						
<p>A - SWITCH AND RELAY POSITIONS AS SHOWN ON CIRCUIT DIAGRAMS INDICATE NORMAL POSITION WITH IGNITION OFF UNLESS OTHERWISE NOTED.</p>		<p>B - MULTIPLE CONNECTIONS ARE DISPLAYED ON SCHEMATIC AS SHOWN WITH R/D NUMBER & CAVITY NUMBER. REFER TO CONNECTOR COMPOSITE FOR MORE INFORMATION</p>						
<p>SWITCH, MECHANICAL SOLENOID RELAY - SUPPRESSED</p>		<p>SINGLE IN-LINE CONNECTORS DISPLAYED AS SHOWN BELOW WITH R/D NUMBER</p>						
<p>C - PHANTOM LINES INDICATE PRINTED CIRCUITS OR BUSSED CIRCUITS. THESE CIRCUITS EXIST IN THE INSTRUMENT CLUSTER AND FUSE / CIRCUIT BREAKER CONNECTORS.</p>								
<p>PRINTED CIRCUIT IN INSTRUMENT CLUSTER VOLTMETER</p>		<p>LOCATION / CIRCUIT NUMBER WIRE GAUGE / WIRE COLOR FUSE RATING</p>						
<p>D - MULTIPLE CIRCUIT NUMBERS ON A LINE INDICATE ONE CIRCUIT DISTRIBUTING CURRENT TO TWO CIRCUITS.</p>								
<p>SPLICE</p>								
<p>E - SWITCHES, RELAYS AND COMPONENTS INDICATE EXTERNAL WIRE CONNECTIONS AND / OR INTERNAL CONNECTIONS OR CONTACTS.</p>								
<p>EXTERNAL WIRE CONNECTIONS</p>		<p>WIRE CONNECTION PIGTAIL</p>						
<p>INTERNAL CONNECTION</p>		<p>BODY CONTROLLER (1602)</p>						
<p>F - CIRCUIT "11" DENOTES ANY COMMON GROUND (MORE THAN ONE CIRCUIT). ANY INDIVIDUAL GROUND CIRCUIT IS IDENTIFIED WITH THAT PARTICULAR CIRCUIT NUMBER. (E.G. CIRCUIT 32 CRUISE CONTROL IS IDENTIFIED AS PER EXAMPLE)</p>								
<p>COMMON GROUND CIRCUIT NUMBER SUFFIX BEGINNING WITH G INDICATES A GROUND CIRCUIT</p>		<p>INDIVIDUAL GROUND CIRCUIT NUMBER LOCATION SUFFIX BEGINNING WITH G INDICATES A GROUND CIRCUIT</p>						
<p>NOTE: FOR CIRCUIT DESCRIPTION OTHER THAN GROUNDS NEITHER THE LETTER "G" NOR THE COLOR WHITE SHALL BE USED</p>								
CHK	DATE	CHANGE	REV	REFERENCE	DRAWN	NAME		
CNA1	11NOV10	INITIAL RELEASE.	A	67696A	U01A133	CIRCUIT DIAGRAM, TERRASTAR		
					RELEASE NO.	DATE	PART NO.	SHEET
					67696A	04AUG10	AE08064593	003

Figure 3 Circuit Diagram Instructions

2.4. CIRCUIT NUMBER IDENTIFICATION AND COLOR, P. 4

NAVISTAR, INC		ELECTRICAL CIRCUIT DIAGRAM CHAPTER 2	
THIS PRINT IS PROVIDED ON A RESTRICTED BASIS AND IS NOT TO BE USED IN ANY WAY DETRIMENTAL TO THE INTEREST OF NAVISTAR, INC.		CIRCUIT NUMBER IDENTIFICATION AND COLOR	
CIRCUIT NUMBER	COLOR	DESCRIPTION	
1	LTBL	ALTERNATOR-FIELD	
2	RD	ALTERNATOR-CHARGE	
3	DKBL	SERIAL / DATA COMMUNICATION J1587 / J1708 (+)	
	GY	SERIAL / DATA COMMUNICATION J1587 / J1708 (-)	
4	DKBL	SERIAL / DATA COMMUNICATION J1922 (+)	
	GY	SERIAL / DATA COMMUNICATION J1922 (-)	
5	YL	SERIAL / DATA COMMUNICATION J1939/11 / J1939/15 (+)	
	GN	SERIAL / DATA COMMUNICATION J1939/11 / J1939/15 (-)	
6	GY	LOW VOLTAGE ELECTRONIC FEED (LESS THAN 9 VOLTS)	
7	RD	ALTERNATOR-RESISTANCE	
8			
9	GY	ZERO VOLT REFERENCE (ZVR)	
10	WH	CHASSIS / ENGINE GROUND	
11	WH	CAB / SLEEPER GROUND	
12	LTBL	ACCESSORY FEED	
13	PK	IGNITION FEED	
	BK	IGNITION FEED (BODY BUILDER CONNECTOR)	
14	RD	BATTERY FEED	
15	RD	KEY SWITCH FEED	
16			
17	PK	STARTER CONTROL	
18	PK	GLOW PLUG / PREHEATER	
19	GY	ENGINE SHUTDOWN	
20	LTGN	REMOTE POWER MODULE	
21	TN	COLD START CONTROLS (ETHER)	
22	TN	TIRE PRESSURE MONITORING / CONTROL	
23	TN	ENGINE FAN / SHUTTERS	
24	GY	ENGINE EXHAUST BRAKE	
25	TN	PYROMETER	
26	TN	AMMETER	
27	TN	VOLTMETER	
28	TN	INSTRUMENT & GAUGES	
29	TN	ENGINE WATER TEMPERATURE	
30	TN	ENGINE OIL TEMPERATURE	
31	TN	TRANSMISSION OIL TEMPERATURE	
32	TN	AXLE OIL TEMPERATURE	
33	TN	ENGINE OIL LEVEL	
34	TN	COOLANT LEVEL	
35	TN	ENGINE OIL PRESSURE	
36	TN	FUEL LEVEL	
37	TN	FUEL PUMP	
38	GY	LEFT AXLE	
39	GY	AIR DRYER HEATER	
40	GY	LOW AIR PRESSURE WARNING	

CHK	DATE	CHANGE	REV	REFERENCE	DRAWN	NAME
CNA1	11NOV10	INITIAL RELEASE.	A	67696A	U01A133	CIRCUIT DIAGRAM, TERRASTAR
					RELEASE NO.	DATE
					67696A	04AUG10
					PART NO.	SHEET
					AE08064593	004

Figure 4 Circuit Number Identification and Color

2.5. CIRCUIT NUMBER IDENTIFICATION AND COLOR (CONT.), P. 5

NAVISTAR, INC		ELECTRICAL CIRCUIT DIAGRAM CHAPTER 2
THIS PRINT IS PROVIDED ON A RESTRICTED BASIS AND IS NOT TO BE USED IN ANY WAY DETRIMENTAL TO THE INTEREST OF NAVISTAR, INC.		CIRCUIT NUMBER IDENTIFICATION AND COLOR (CONT)
CIRCUIT NUMBER	COLOR	DESCRIPTION
41	TN	AIR TEMPERATURE
42	GY	FRONT AXLE ENGAGED
43	GY	POWER DIVIDER LOCK (PDL) WARNING
44	GY	PARK BRAKE WARNING
45	LTGN	ANTITHEFT WARNING
46	GY	POWER TAKEOFF WARNING
47	GY	SPEEDOMETER
48	GY	TACHOMETER
49	GY	DIFFERENTIAL LOCK WARNING
50	YL	LIGHT SWITCH FEED
51	YL	DIMMER SWITCH FEED
52	YL	HEADLIGHT HI - BEAM
53	YL	HEADLIGHT LO - BEAM
54	BN	PARKING / MARKER LIGHTS
55	OR	TURN SIGNAL - FEED
56	OR	TURN SIGNAL LIGHTS - LEFT
	YL	TURN SIGNAL LIGHTS - LEFT (BODY BUILDER CONNECTION)
57	OR	TURN SIGNAL LIGHTS - RIGHT
	LTGN	TURN SIGNAL LIGHTS - RIGHT (BODY BUILDER CONNECTION)
58	BN	CLEARANCE / IDENTIFICATION LIGHTS
59	GY	SOLENOID
60	OR	HAZARD LIGHTS
61	GY	AIR SUSPENSION
62	DKBL	PANEL LIGHTS
63	DKBL	COURTESY / DOME LIGHTS
64	YL	FOG / DRIVING LIGHTS
65	OR	CAB REAR FLOOD LIGHTS
66	YL	DAYTIME RUNNING LIGHTS
67	GY	OBSTACLE AVOIDANCE / REMOTE SENSOR
68	BN	TAIL LIGHTS
69	BN	LICENSE PLATE LIGHT
70	OR	STOP LIGHTS
	RD	STOP LIGHTS (BODY BUILDER CONNECTION)
71	OR	BACK-UP LIGHTS
	LTBL	BACK-UP LIGHTS (BODY BUILDER CONNECTION)
72	OR	TRAILER AUXILIARY FEED - BATTERY
73	LTGN	PWM
74	LTGN	HEATER RECIRC MOTOR
75	LTGN	HEATER BLOWER MOTOR
76	LTGN	AUXILIARY FAN
77	LTGN	AIR CONDITIONER
78	LTGN	MIRRORS - HEATED, MOTORIZED
79	GY	SEAT BELTS
80	BK	SLEEPER BOX RELAY - FEED

CHR	DATE	CHANGE	REV	REFERENCE	DRAWN	NAME
CN1	11NOV10	INITIAL RELEASE.	A	67696A	U01A133	CIRCUIT DIAGRAM, TERRASTAR
					RELEASE NO.	DATE
					67696A	04AUG10
					PART NO.	SHEET
					AE08064593	005

Figure 5 Circuit Number Identification and Color (Cont.)

2.6. CIRCUIT NUMBER IDENTIFICATION AND COLOR (CONT.), P. 6

NAVISTAR, INC				ELECTRICAL CIRCUIT DIAGRAM CHAPTER 2			
THIS PRINT IS PROVIDED ON A RESTRICTED BASIS AND IS NOT TO BE USED IN ANY WAY DETRIMENTAL TO THE INTEREST OF NAVISTAR, INC.				CIRCUIT NUMBER IDENTIFICATION AND COLOR (CONT.)			
CIRCUIT NUMBER	COLOR	DESCRIPTION					
81	LTGN	POWER DOOR LOCKS					
82	GY	WINDSHIELD WIPER					
83	LTGN	POWER WINDOWS					
84	LTGN	CIGAR LIGHTER					
85	GY	HORN					
86	LTGN	RADIO - ENTERTAINMENT / CLOCK					
87	GY	WINDSHIELD WASHER					
88	LTGN	CLOCK / HOURMETER					
89	VT	AIR BAG					
90	GY	HYDRAULIC BRAKE PUMP					
91	VT	INTERCOMMUNICATION					
92	TN	TRANSMISSION CONTROLS - ELECTRONICS					
93	TN	AXLE SHIFT CONTROL					
94	GY	ANTILOCK BRAKE SYSTEM					
95	TN	EXHAUST EMISSION					
96	YL	SNOW PLOW LIGHTS / CRUISE CONTROLS					
97	VT	ENGINE CONTROLS - ELECTRONIC					
98	BK	DATALINK AND DIAGNOSTICS					
99	VT	ACCELERATOR POSITION SENSOR (APS)					
100	GY	AIR HORN (ELECTRIC SOLENOID ACTUATED)					
101	TN	BRAKE APPLICATION AIR					
102	YL	FLASH TO PASS					
103	LTGN	BODY BUILDER AUXILIARY FEED					
104	DKBL	REMOTE START / STOP					
105	LTGN	HEATED SEATS					
106	OR	HIGH VOLTAGE ALTERNATOR AC CHARGE					
107	GY	INSTRUMENT CLUSTER ELECTRONIC FEED (5V)					
108	GY	BRAKE PAD WEAR SENSOR					
109	GY	BRAKE STROKE / SLACK ADJUSTER					
110	GY	INSTRUMENT CLUSTER ELECTRONIC GROUND					
111	TN	FUEL FILTER RESTRICTION TRANSDUCER					
112	GY	LEFT GATE					

PREFIX	LOCATION
A	CAB - INSTRUMENT PANEL MODULE
B	CAB - DRIVER CONTROL MODULE
C	CAB - HEADER / CLEARANCE LIGHTS
D	CAB - ROOF / REAR PANEL
E	CAB - LEFT DOOR / DOORS
F	CAB - RIGHT DOOR / DOORS
H	CAB - SLEEPER
J	CAB - DASH (OUTSIDE)
K	ENGINE / RADIATOR
L	TRANSMISSION
M	CHASSIS / FRONT END (CAB DASH PANEL FORWARD)
N	CHASSIS / CENTER SECTION (CAB DASH PANEL TO CAB REAR XMBR)
P	CHASSIS / WHEEL BASE SECTION
R	CHASSIS / SUSPENSION / REAR AXLE / AXLES
S	CHASSIS / AF SECTION / STOP / TAIL / TURN LIGHTS
T	TRAVEL DOORS
U	HOOD MTD HEADLIGHTS / MARKER LIGHTS
V	SLEEPER ROOF / BACK PANEL WIRING
W	WARDROBE CABINET WIRING

CHK	DATE	CHANGE	REV	REFERENCE	DRAWN	NAME
	11NOV10	INITIAL RELEASE.	A	67696A	U01A133	CIRCUIT DIAGRAM, TERRASTAR
					RELEASE NO.	DATE
					67696A	04AUG10
					PART NO.	SHEET
					AE08064593	006

Figure 6 Circuit Number Identification and Color (Cont.)

2.7. LAMP BULB CHART, P. 7

<p>NAVISTAR, INC</p> <p><small>THIS PRINT IS PROVIDED ON A RESTRICTED BASIS AND IS NOT TO BE USED IN ANY WAY DETRIMENTAL TO THE INTEREST OF NAVISTAR, INC.</small></p>				<p>ELECTRICAL CIRCUIT DIAGRAM CHAPTER 2</p> <p>LAMP BULB CHART</p>																																																																									
<table border="1" style="width: 100%; border-collapse: collapse;"> <thead> <tr> <th style="width: 50%;">BULB APPLICATION</th> <th style="width: 20%;">CANDLEPOWER OR WATT</th> <th style="width: 30%;">BULB TRADE NUMBER</th> </tr> </thead> <tbody> <tr><td>BACK-UP LIGHTS</td><td>32 CP</td><td>GE1156</td></tr> <tr><td>CLEARANCE & IDENTIFICATION SMALL</td><td>3 CP</td><td>GE168</td></tr> <tr><td>COURTESY LIGHT</td><td>21 CP</td><td>1142</td></tr> <tr><td>DOVE LIGHTS</td><td>21 CP</td><td>1142</td></tr> <tr><td>FOG LIGHTS</td><td>100 WATT</td><td>4921 - 1</td></tr> <tr><td>LOW BEAMS</td><td>55 WATT</td><td>GE9007</td></tr> <tr><td>HIGH BEAMS</td><td>60 WATT</td><td>GE9007</td></tr> <tr><td>CIGAR LIGHTER</td><td>1 CP</td><td>1455</td></tr> <tr><td>MAP LIGHT</td><td>3 CP</td><td>1816</td></tr> <tr><td>SIDE MARKER</td><td></td><td>2548</td></tr> <tr><td>STOP & TURN / TAIL & LICENSE PLATE</td><td>32 / 3 CP</td><td>3157</td></tr> <tr><td>TURN SIGNAL / MARKER (FENDER)</td><td>32 / 3 CP</td><td>3157</td></tr> <tr><td>TURN SIGNAL & MARKER LIGHT</td><td></td><td>2356</td></tr> <tr><td>WORK (TRAILER HOOK)</td><td>35 WATT</td><td>4411</td></tr> <tr><td>BACK-UP LIGHTS UPPER AND LOWER BUNK READING LIGHT</td><td>15 CP</td><td>1003</td></tr> <tr><td>CABINET / WARDROBE LIGHT</td><td>5W</td><td>7575</td></tr> <tr><td>UNDER BUNK LIGHT</td><td>21 CP / 2 (12 CP)</td><td>577 / 211</td></tr> <tr><td>ACCENT LIGHT</td><td>2 (12 CP)</td><td>211</td></tr> <tr><td>DOVE LIGHT LAMP</td><td>15 WATT</td><td>F15TB - CW</td></tr> <tr><td>SLEEPER FLOOR LIGHT</td><td>4 CP</td><td>W5W</td></tr> <tr><td>HEATER AND AIR CONDITIONER CONTROL</td><td>3 CP</td><td>168</td></tr> <tr><td>LUGGAGE COMPARTMENT LIGHT</td><td>6 CP</td><td>99</td></tr> <tr><td>READING LIGHT</td><td>15 CP</td><td>1003</td></tr> </tbody> </table>						BULB APPLICATION	CANDLEPOWER OR WATT	BULB TRADE NUMBER	BACK-UP LIGHTS	32 CP	GE1156	CLEARANCE & IDENTIFICATION SMALL	3 CP	GE168	COURTESY LIGHT	21 CP	1142	DOVE LIGHTS	21 CP	1142	FOG LIGHTS	100 WATT	4921 - 1	LOW BEAMS	55 WATT	GE9007	HIGH BEAMS	60 WATT	GE9007	CIGAR LIGHTER	1 CP	1455	MAP LIGHT	3 CP	1816	SIDE MARKER		2548	STOP & TURN / TAIL & LICENSE PLATE	32 / 3 CP	3157	TURN SIGNAL / MARKER (FENDER)	32 / 3 CP	3157	TURN SIGNAL & MARKER LIGHT		2356	WORK (TRAILER HOOK)	35 WATT	4411	BACK-UP LIGHTS UPPER AND LOWER BUNK READING LIGHT	15 CP	1003	CABINET / WARDROBE LIGHT	5W	7575	UNDER BUNK LIGHT	21 CP / 2 (12 CP)	577 / 211	ACCENT LIGHT	2 (12 CP)	211	DOVE LIGHT LAMP	15 WATT	F15TB - CW	SLEEPER FLOOR LIGHT	4 CP	W5W	HEATER AND AIR CONDITIONER CONTROL	3 CP	168	LUGGAGE COMPARTMENT LIGHT	6 CP	99	READING LIGHT	15 CP	1003
BULB APPLICATION	CANDLEPOWER OR WATT	BULB TRADE NUMBER																																																																											
BACK-UP LIGHTS	32 CP	GE1156																																																																											
CLEARANCE & IDENTIFICATION SMALL	3 CP	GE168																																																																											
COURTESY LIGHT	21 CP	1142																																																																											
DOVE LIGHTS	21 CP	1142																																																																											
FOG LIGHTS	100 WATT	4921 - 1																																																																											
LOW BEAMS	55 WATT	GE9007																																																																											
HIGH BEAMS	60 WATT	GE9007																																																																											
CIGAR LIGHTER	1 CP	1455																																																																											
MAP LIGHT	3 CP	1816																																																																											
SIDE MARKER		2548																																																																											
STOP & TURN / TAIL & LICENSE PLATE	32 / 3 CP	3157																																																																											
TURN SIGNAL / MARKER (FENDER)	32 / 3 CP	3157																																																																											
TURN SIGNAL & MARKER LIGHT		2356																																																																											
WORK (TRAILER HOOK)	35 WATT	4411																																																																											
BACK-UP LIGHTS UPPER AND LOWER BUNK READING LIGHT	15 CP	1003																																																																											
CABINET / WARDROBE LIGHT	5W	7575																																																																											
UNDER BUNK LIGHT	21 CP / 2 (12 CP)	577 / 211																																																																											
ACCENT LIGHT	2 (12 CP)	211																																																																											
DOVE LIGHT LAMP	15 WATT	F15TB - CW																																																																											
SLEEPER FLOOR LIGHT	4 CP	W5W																																																																											
HEATER AND AIR CONDITIONER CONTROL	3 CP	168																																																																											
LUGGAGE COMPARTMENT LIGHT	6 CP	99																																																																											
READING LIGHT	15 CP	1003																																																																											
CHR	DATE	CHANGE	REV	REFERENCE	DRAWN	NAME																																																																							
CNA1	11NOV10	INITIAL RELEASE.	A	67696A	U01A133	CIRCUIT DIAGRAM, TERRASTAR																																																																							
					RELEASE NO.	DATE																																																																							
					67696A	04AUG10																																																																							
						PART NO.																																																																							
						AE08064593																																																																							
						SHEET																																																																							
						007																																																																							

Figure 7 Lamp Bulb Chart

2.8. RELAY FUNCTION AND WIRING DIAGRAM, P. 8

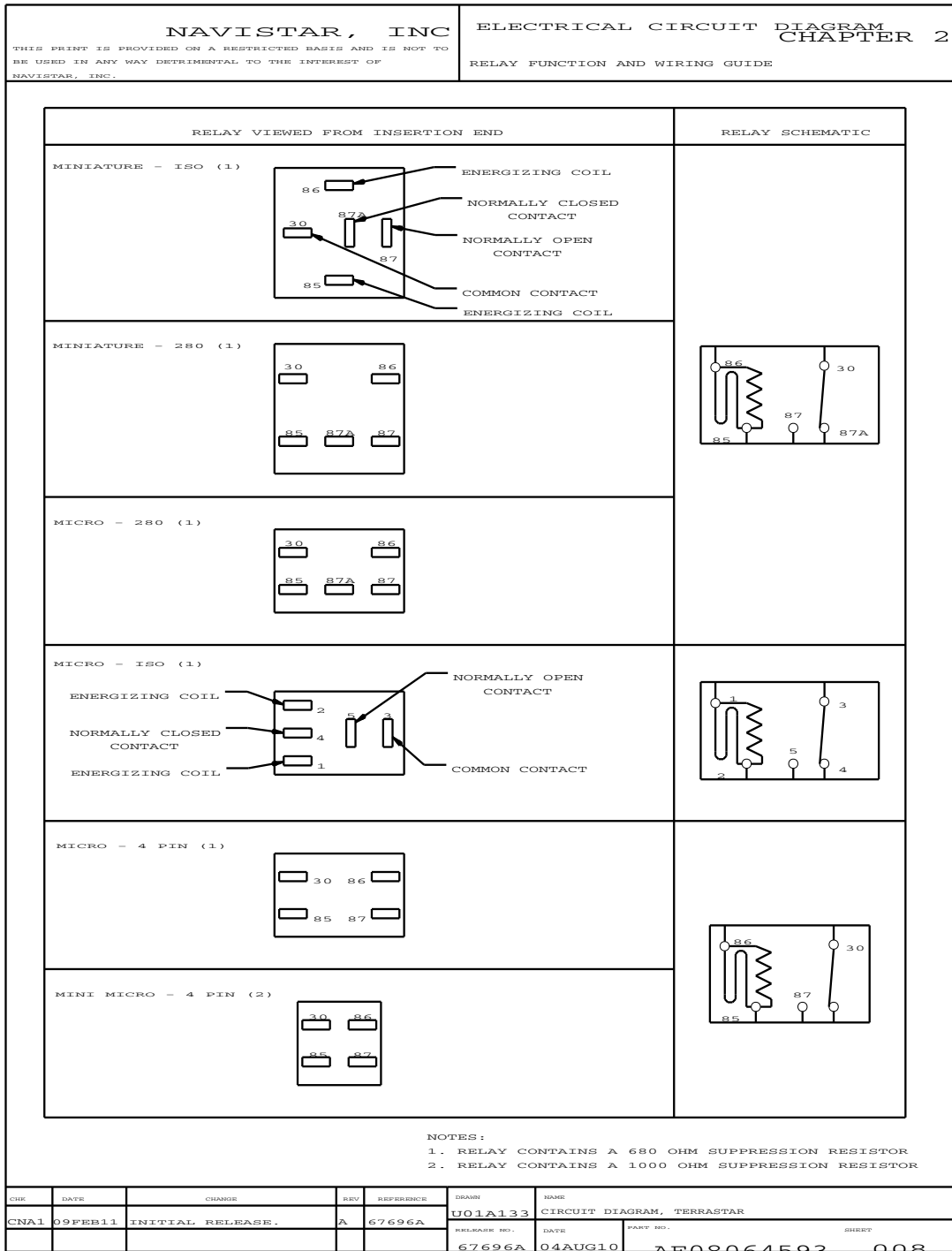

Figure 8 Relay Function and Wiring Diagram

2.9. SCHEMATIC SYMBOL CHART, P. 9









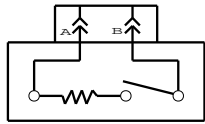
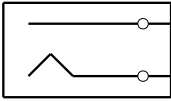
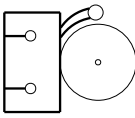

NAVISTAR, INC				ELECTRICAL CIRCUIT DIAGRAM CHAPTER 2			
THIS PRINT IS PROVIDED ON A RESTRICTED BASIS AND IS NOT TO BE USED IN ANY WAY DETRIMENTAL TO THE INTEREST OF NAVISTAR, INC.				SCHEMATIC SYMBOL CHART			
SYMBOL				SYMBOL			
	DESCRIPTION				DESCRIPTION		
	AIR DRYER				CIGAR LIGHTER		
	DESCRIPTION			TYPE 1 TYPE 2 OR 3	DESCRIPTION		
	ALARM					CIRCUIT BREAKER	
	DESCRIPTION				DESCRIPTION		
	ALTERNATOR				DIODE		
	DESCRIPTION				DESCRIPTION		
	AMMETER				DIODE, LIGHT EMITTING		
	DESCRIPTION				DESCRIPTION		
	BATTERY				FAN SOLENOID		
	DESCRIPTION				DESCRIPTION		
	BLUNT CUT CIRCUIT				FEMALE TERMINAL		
	DESCRIPTION				DESCRIPTION		
	BUSBAR				FUSE		
CHR	DATE	CHANGE	REV	REFERENCE	DRAWN	NAME	
CNA1	11NOV10	INITIAL RELEASE.	A	67696A	U01A133	CIRCUIT DIAGRAM, TERRASTAR	
					RELEASE NO.	DATE	PART NO.
					67696A	04AUG10	AE08064593
							SHEET 009

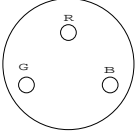
Figure 9 Schematic Symbol Chart

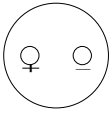
2.10. SCHEMATIC SYMBOL CHART (CONT.), P. 10

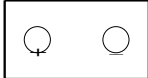
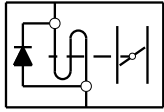
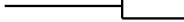









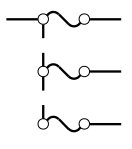
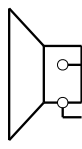

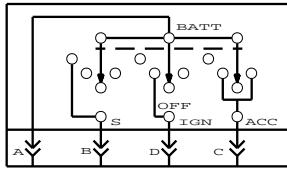
NAVISTAR, INC					ELECTRICAL CIRCUIT DIAGRAM				
THIS PRINT IS PROVIDED ON A RESTRICTED BASIS AND IS NOT TO BE USED IN ANY WAY DETRIMENTAL TO THE INTEREST OF NAVISTAR, INC.					CHAPTER 2				
					SCHEMATIC SYMBOL CHART (CONT)				
SYMBOL	DESCRIPTION				SYMBOL	DESCRIPTION			
	FUSES W/ BUSBAR					HORN			
	FUSIBLE LINK					KEY SWITCH			
	GROUND N/ STUD					KEY SWITCH, COMPLEX			
	GROUND W/ STUD					LIGHT W/ SWITCH			
	HEATER					LIGHT, DOUBLE FILAMENT			
	HOLDER, FUSE W/ BUSBAR					LIGHT, SINGLE FILAMENT			
	BRACE								
CHR	DATE	CHANGE	REV	REFERENCE	DRAWN	NAME			
CNAL	11NOV10	INITIAL RELEASE.	A	67696A	U01A133	CIRCUIT DIAGRAM, TERRASTAR			
					RELEASE NO.	DATE	PART NO.	SHEET	
					67696A	04AUG10	AE08064593	010	

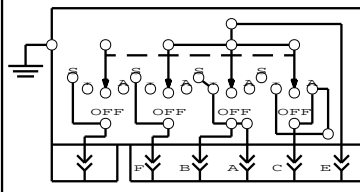
Figure 10 Schematic Symbol Chart (Cont.)

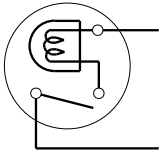
2.11. SCHEMATIC SYMBOL CHART (CONT.), P. 11

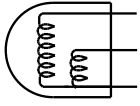





NAVISTAR, INC				ELECTRICAL CIRCUIT DIAGRAM			
THIS PRINT IS PROVIDED ON A RESTRICTED BASIS AND IS NOT TO BE USED IN ANY WAY DETRIMENTAL TO THE INTEREST OF NAVISTAR, INC.				CHAPTER 2			
SCHEMATIC SYMBOL CHART (CONT)							
SYMBOL	DESCRIPTION			SYMBOL	DESCRIPTION		
	MALE TERMINAL				RESISTOR		
	MOTOR				SENDER - FUEL, OIL, WATER		
	PASS THRU CONNECTION				SENSOR, PRESSURE. ABS 6		
	PRESSURE SWITCH				SENSOR, MAGNETIC		
	RELAY, FIVE TERMINAL				SENSOR, YAW		
	RELAY, FOUR TERMINAL				SOLENOID		
	RELAY, LATCHING				SOLENOID W/ DIODE		
CHK	DATE	CHANGE	REV	REFERENCE	DRAWN	NAME	
CNAL	11NOV10	INITIAL RELEASE.	A	67696A	U01A133	CIRCUIT DIAGRAM, TERRASTAR	
					RELEASE NO.	DATE	PART NO.
					67696A	04AUG10	AE08064593
							SHEET
							011

Figure 11 Schematic Symbol Chart (Cont.)

2.12. SCHEMATIC SYMBOL CHART (CONT.), P. 12

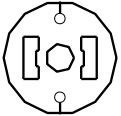
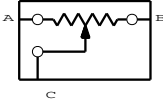
NAVISTAR, INC				ELECTRICAL CIRCUIT DIAGRAM			
THIS PRINT IS PROVIDED ON A RESTRICTED BASIS AND IS NOT TO BE USED IN ANY WAY DETRIMENTAL TO THE INTEREST OF NAVISTAR, INC.				CHAPTER 2			
SCHEMATIC SYMBOL CHART (CONT)				SCHEMATIC SYMBOL CHART (CONT)			
SYMBOL		DESCRIPTION		SYMBOL		DESCRIPTION	
		SPEAKER				SWITCH, PUSH BUTTON	
		SPLICE				TERMINATING RESISTOR	
		STUD				THERMOSTAT	
		START MOTOR W/ TOCP				VALVE, ETHER BOTTLE	
		SWITCH, MECHANICAL (NORMALLY OPEN)				VALVE, MODULATOR	
		SWITCH, MECHANICAL (NORMALLY CLOSED)				DIODE ASSEMBLY	
CHK	DATE	CHANGE	REV	REFERENCE	DRAWN	NAME	
CN1	11NOV10	INITIAL RELEASE.	A	67696A	U01A133	CIRCUIT DIAGRAM, TERRASTAR	
					RELEASE NO.	DATE	PART NO.
					67696A	04AUG10	AE08064593
							SHEET 012

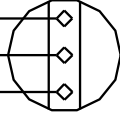
Figure 12 Schematic Symbol Chart (Cont.)

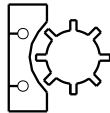
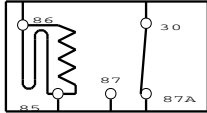
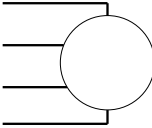
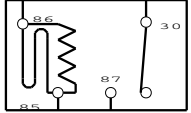
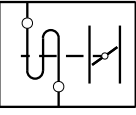
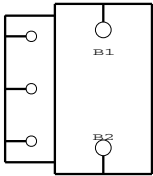
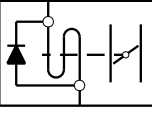
12 VOLT POWER DISTRIBUTION, GROUNDS, DATA BUS AND ELECTRICAL SYSTEM CONTROLLER (CHAPTER 3)

3.1. BATTERY FEED, DUAL, P. 1

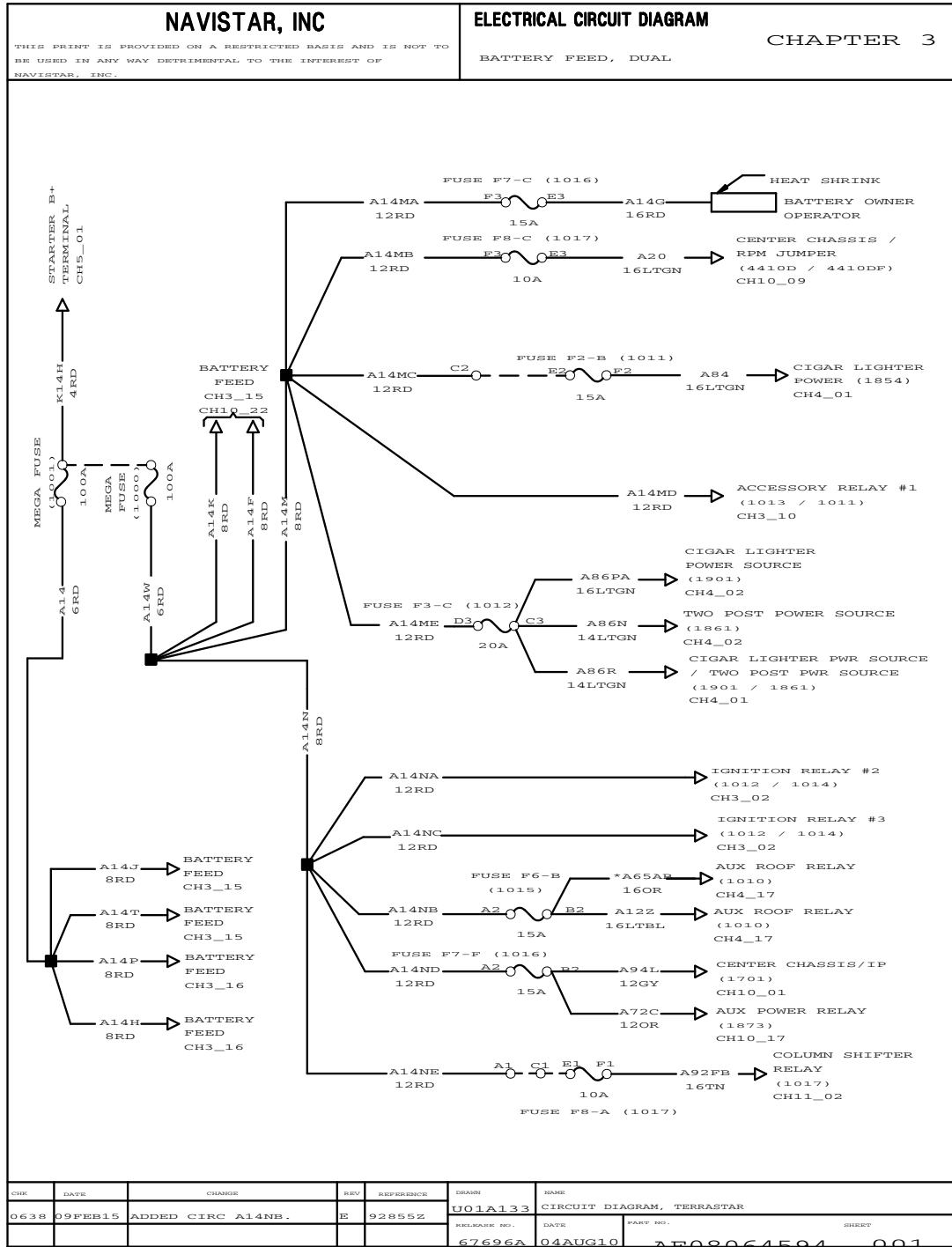

Figure 13 Battery Feed, Dual

3.3. J708 DATA LINK – PUBLIC EFFECTS, P. 3

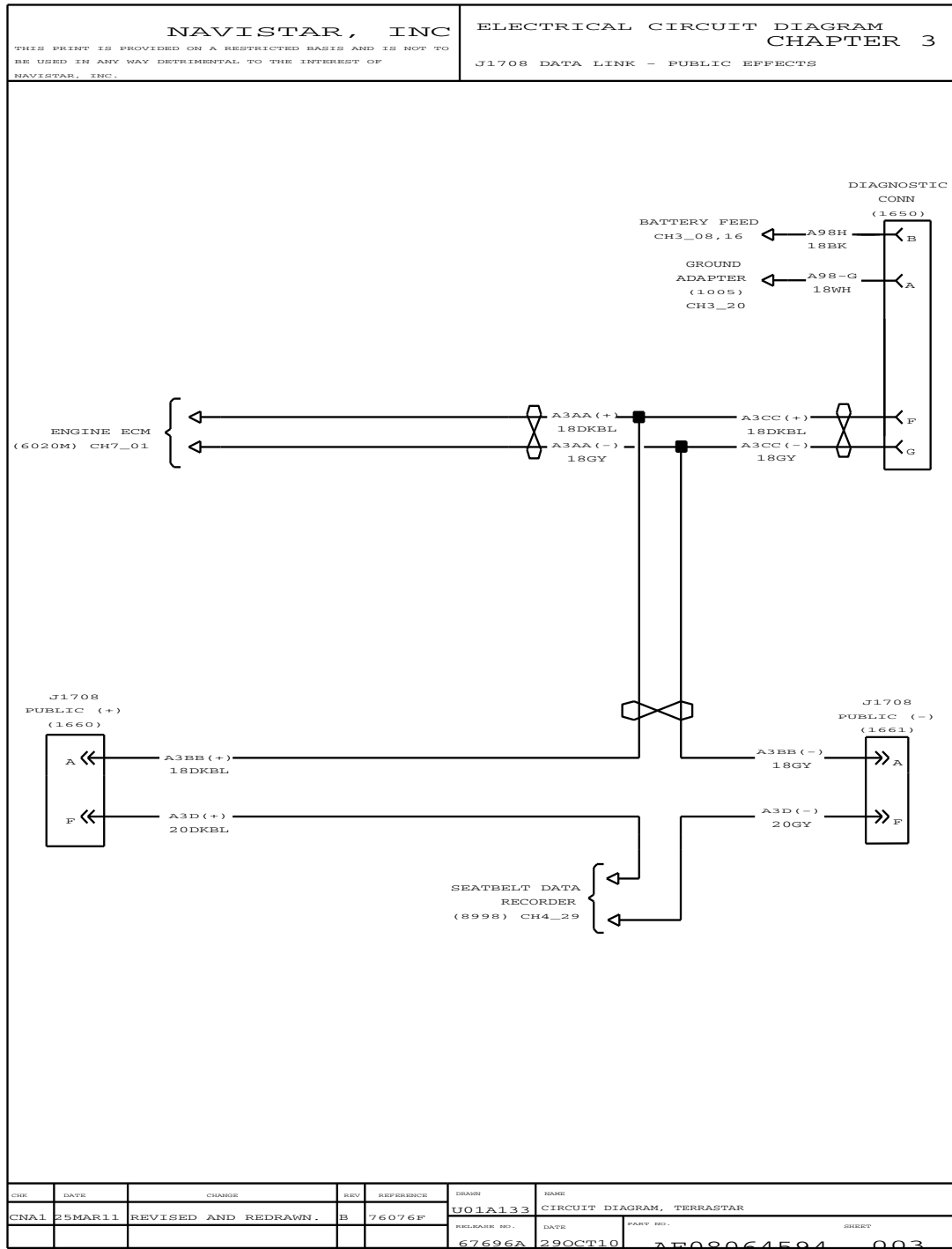

Figure 15 J708 Data Link – Public Effects

3.4. J1708 DATA LINK – PRIVATE WITH POWER WINDOW AND LOCK, P. 4

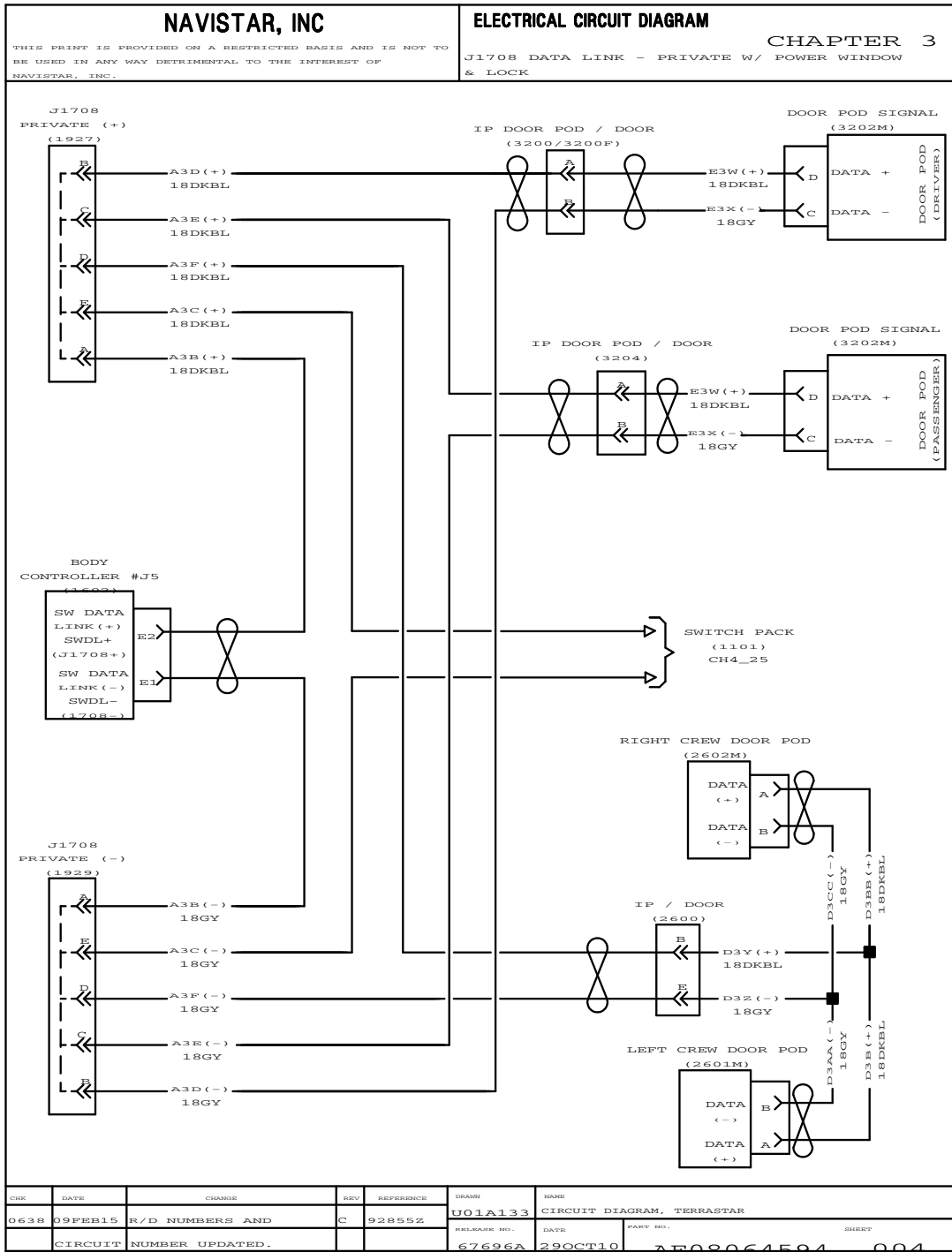

Figure 16 J1708 Data Link – Private with Power Window and Lock

3.5. J1939 DATA LINK, P. 5

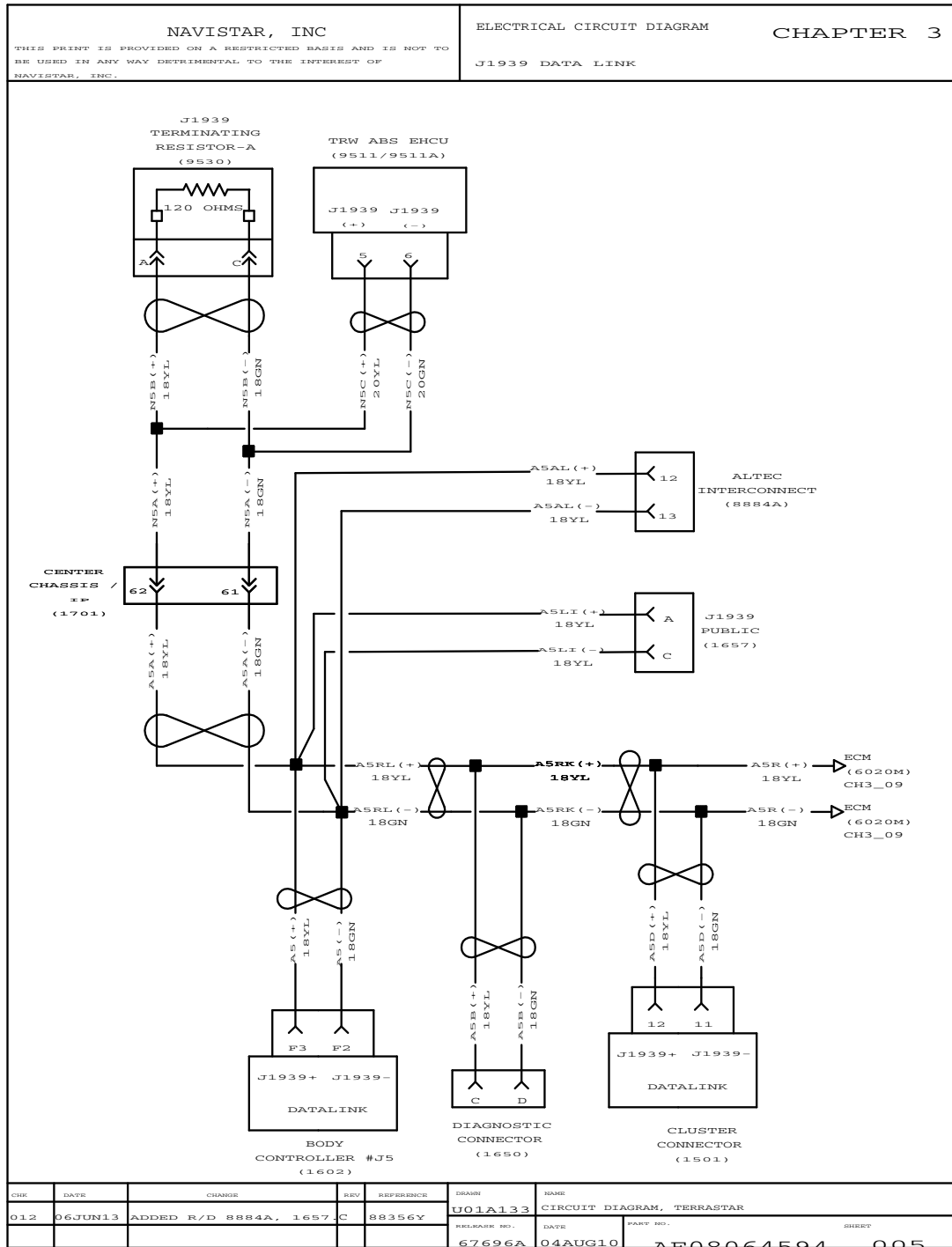

Figure 17 J1939 Data Link

3.6. GROUND – IP, P. 6

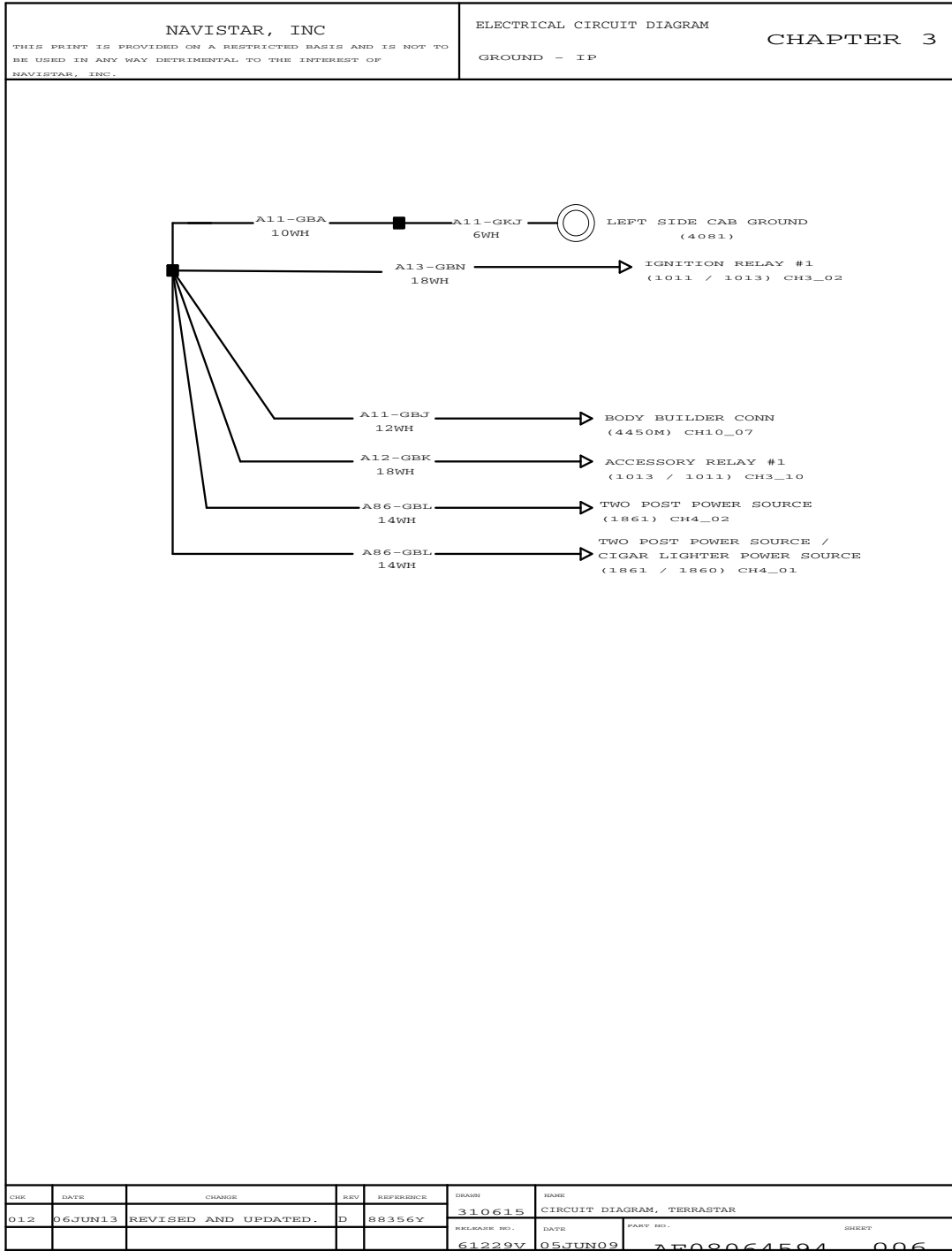

Figure 18 Ground – IP

3.7. ZERO VOLT REFERENCE, P. 7

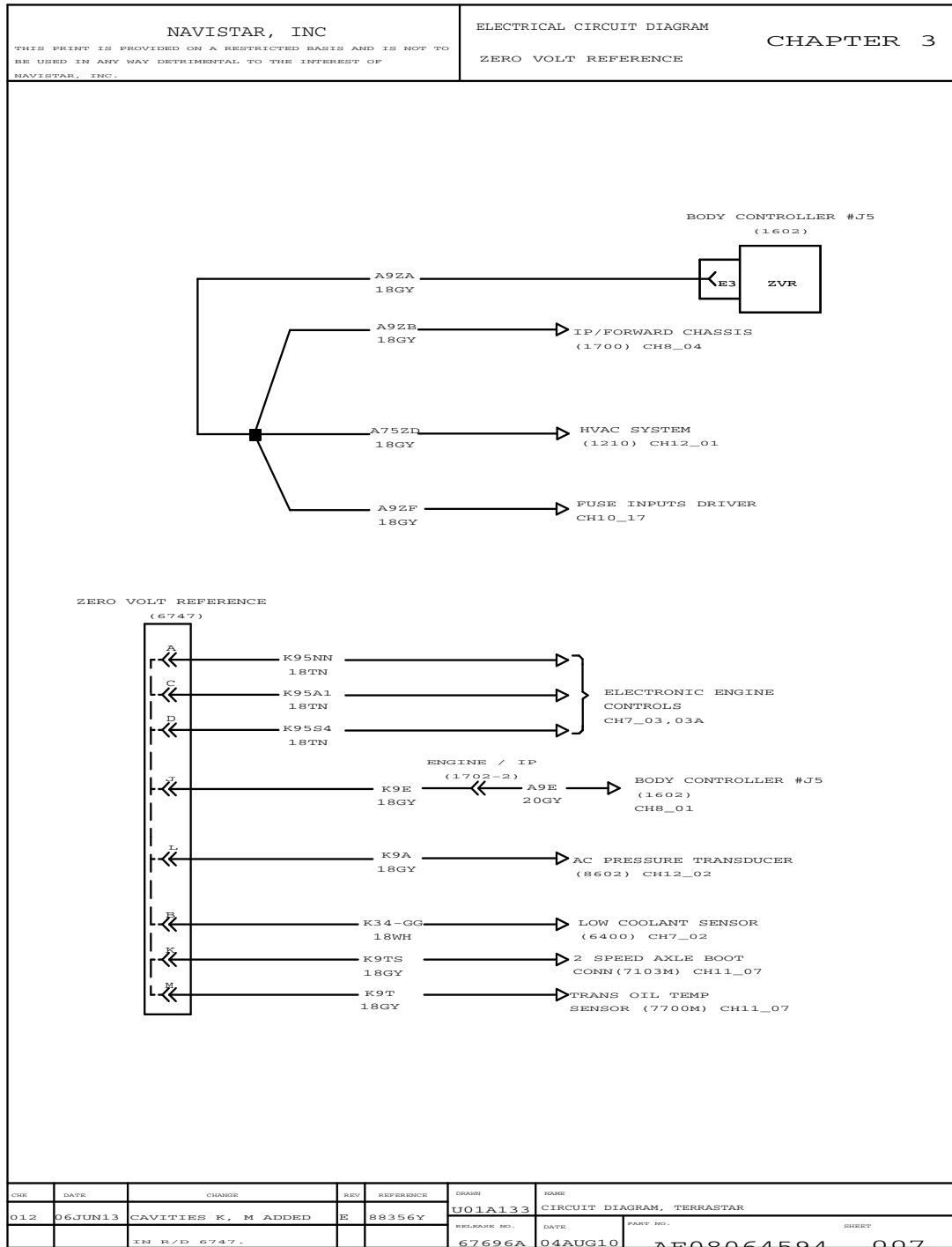

Figure 19 Zero Volt Reference

3.8. BATTERY FEED, SINGLE, P. 8

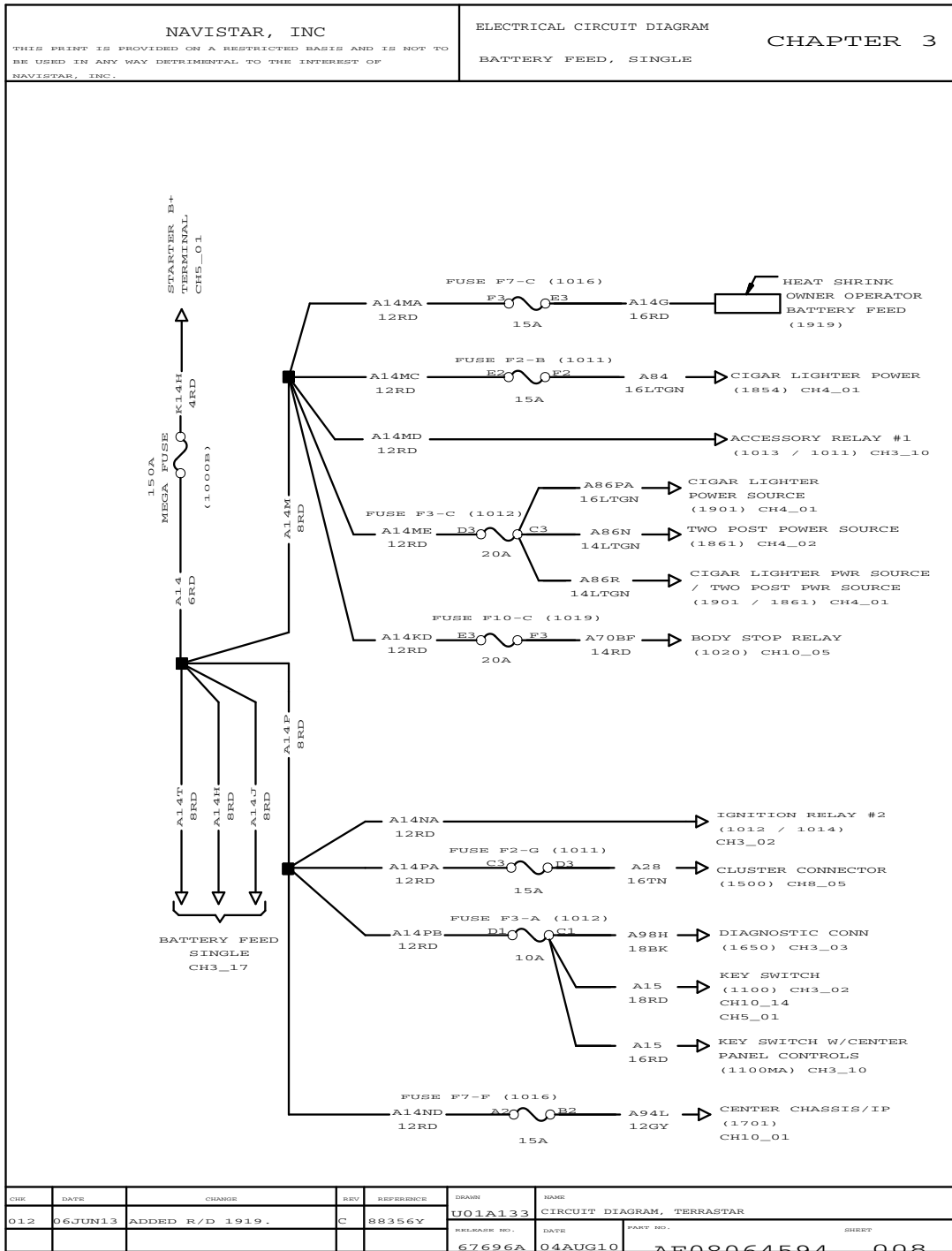

Figure 20 Battery Feed, Single

3.9. J1939 DATA LINK – V8 ENGINE, P. 9

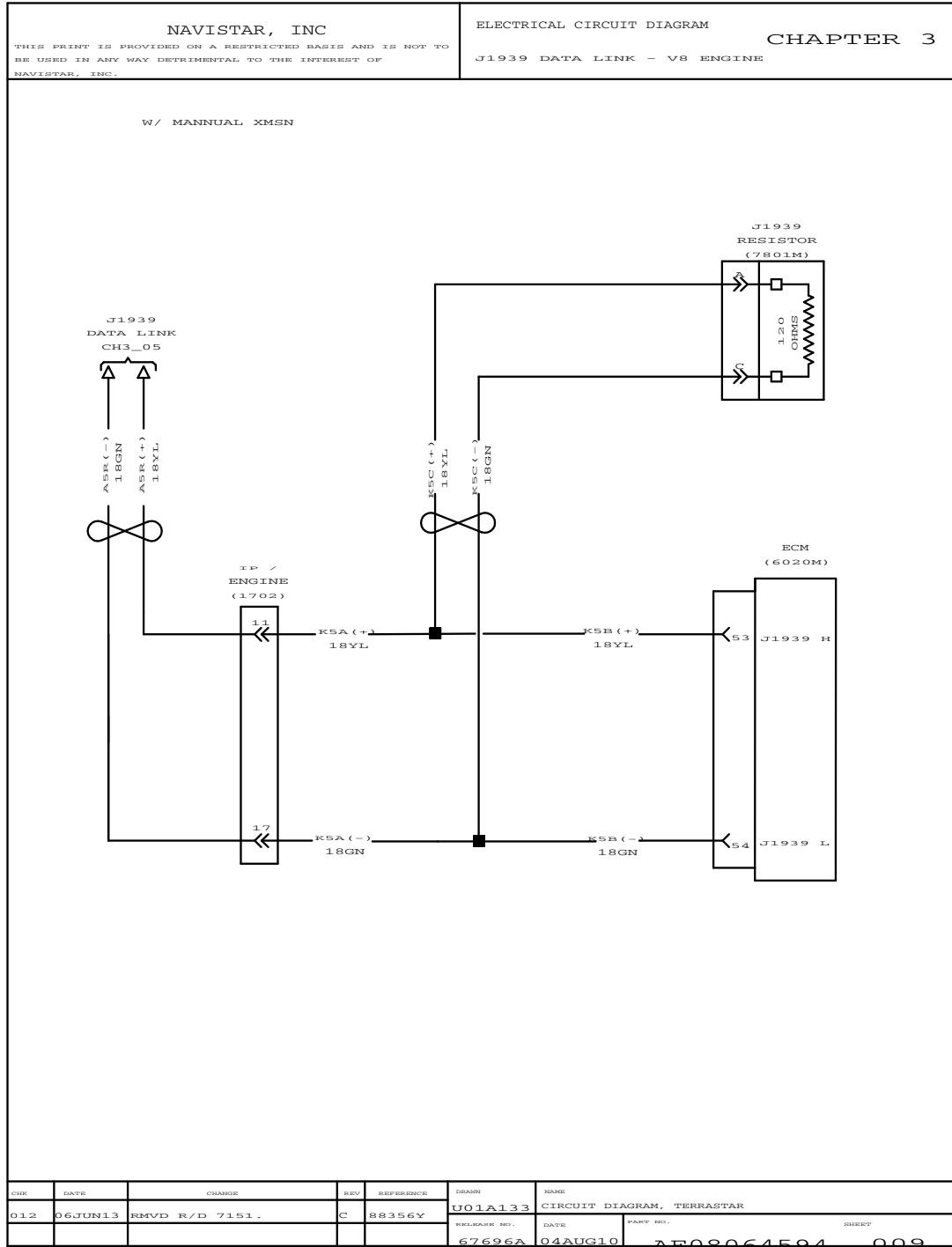

Figure 21 J1939 Data Link – V8 Engine

3.10. J1939 DATA LINK – V8 ENGINE WITH ALLISON WTEC, P. 9A

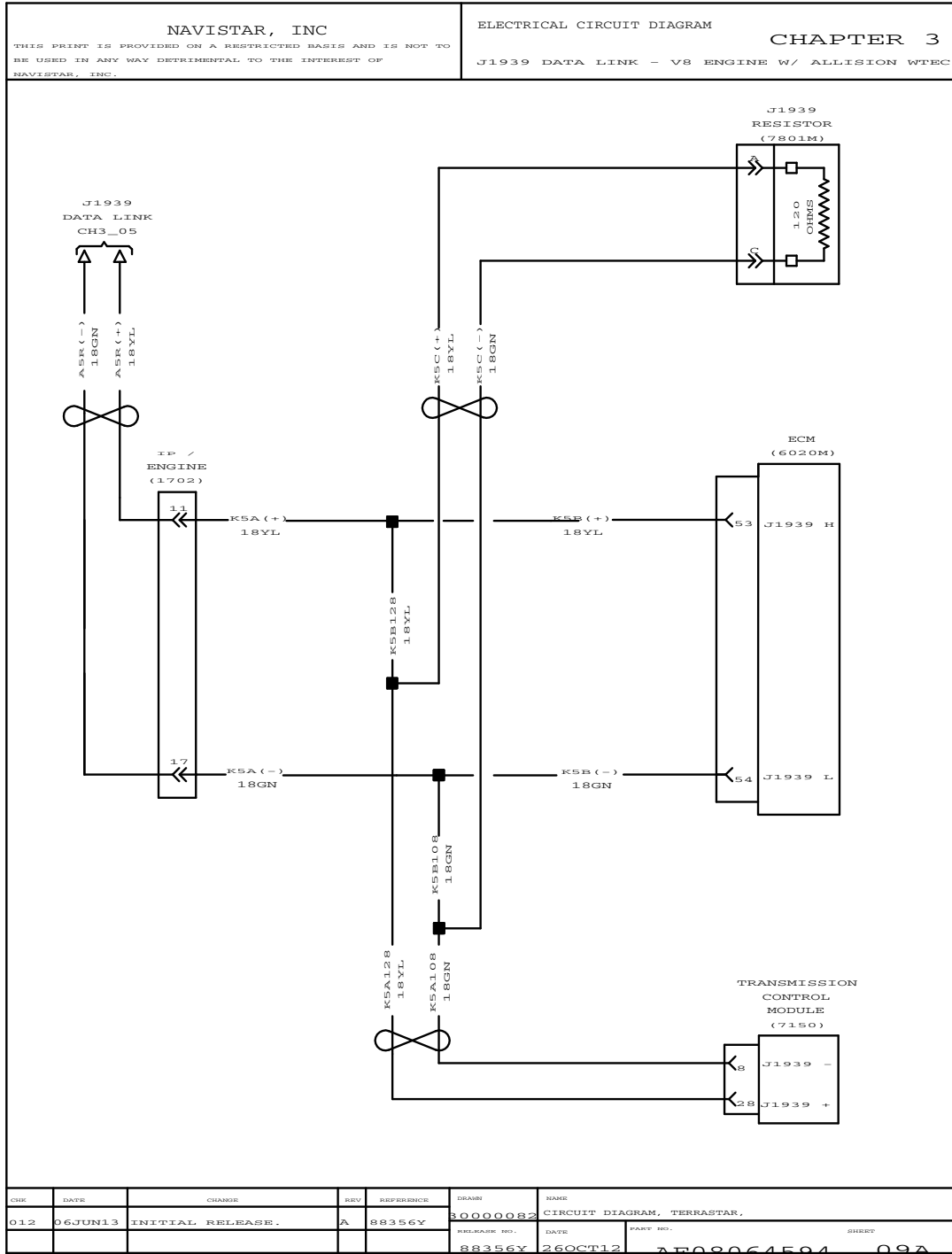

Figure 22 J1939 Data Link – V8 Engine with Allison WTEC

3.11. J1939 DATA LINK – V8 ENGINE WITH ALLISON LCT WITH IN-CAB TCM, P. 9B

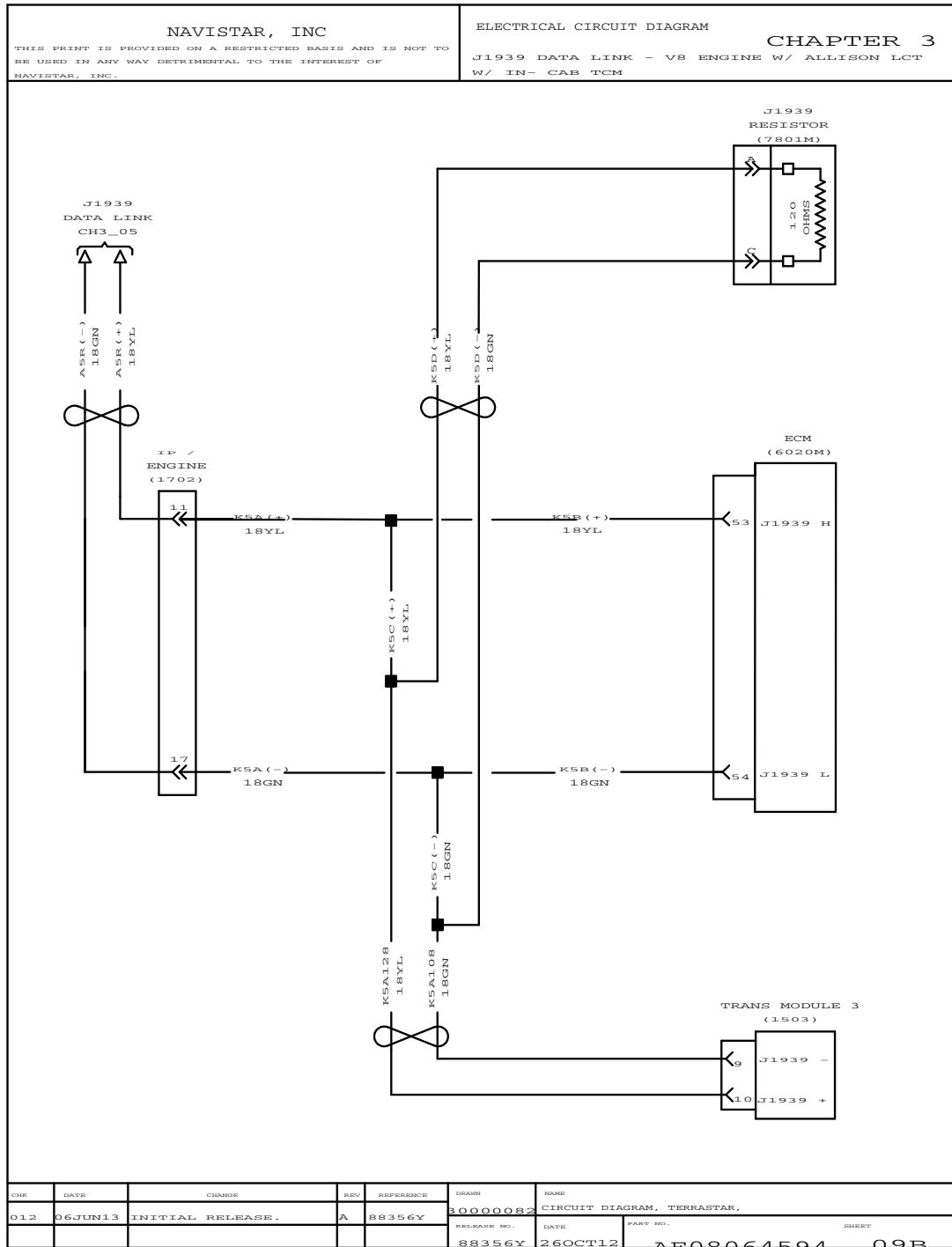

Figure 23 J1939 Data Link – V8 Engine with Allison LCT with In-Cab TCM

3.12. ACCESSORY FEED, P. 10

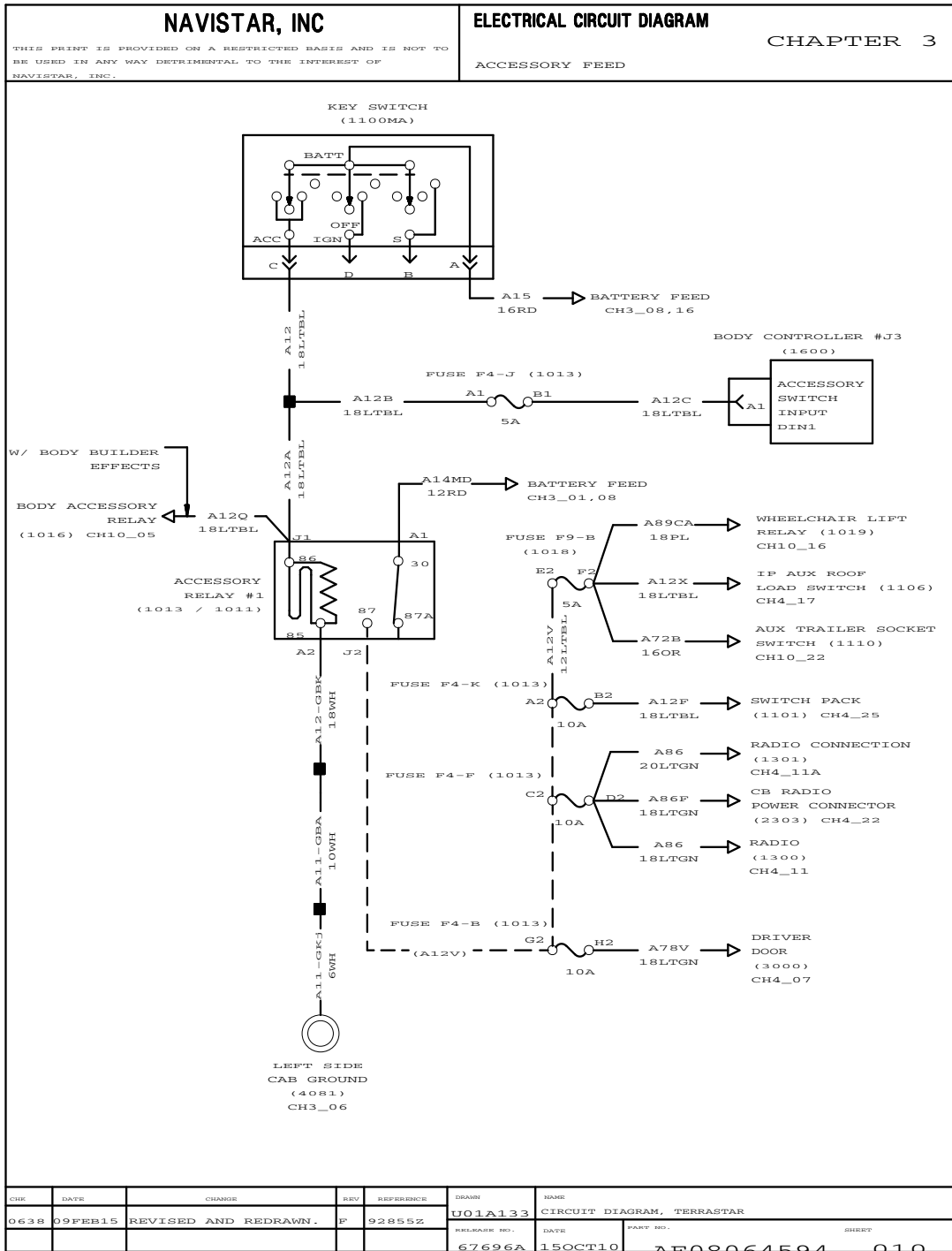

Figure 24 Accessory Feed

3.13. J1939 DATA LINK – WITH OPTIONS, P. 11

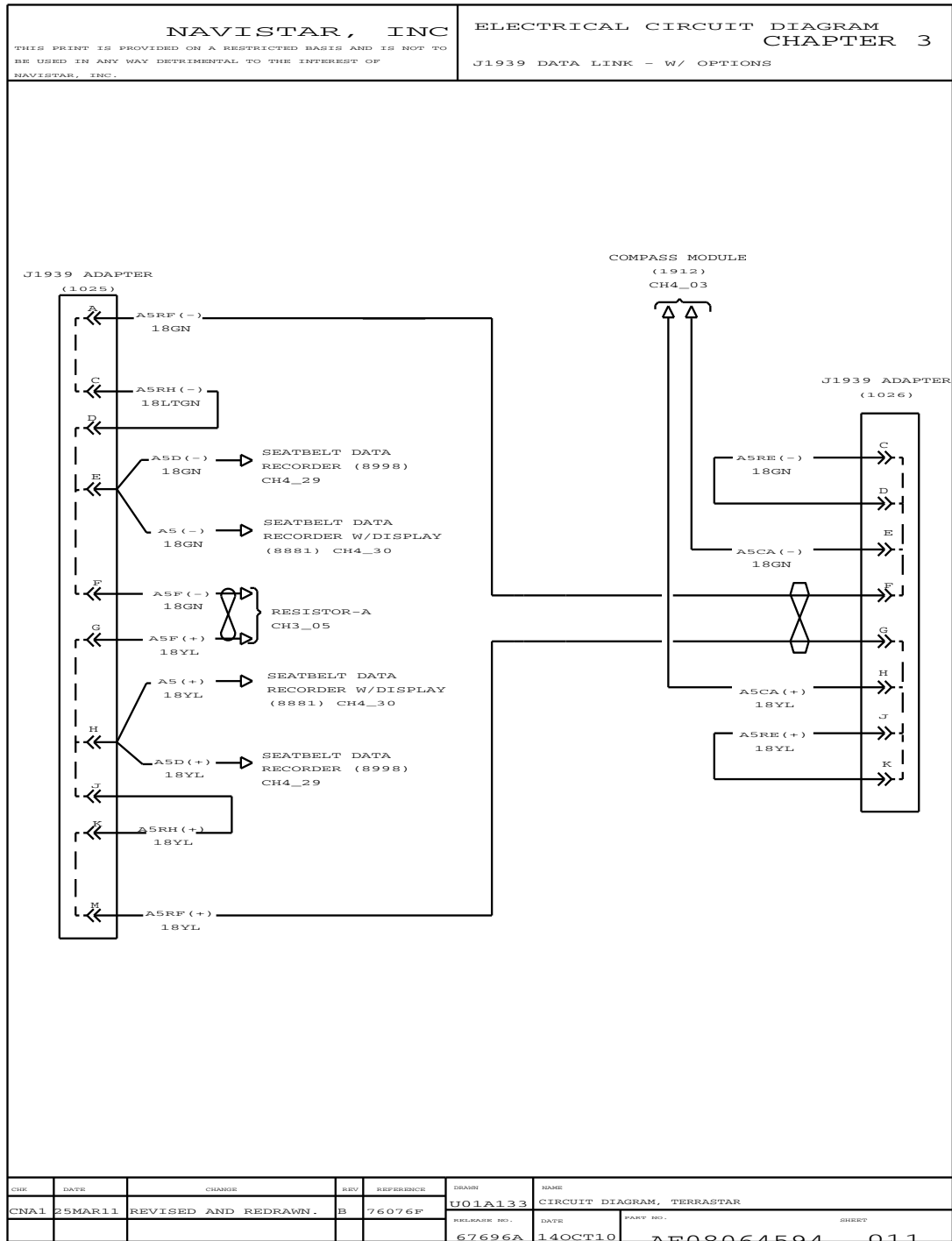

Figure 25 J1939 Data Link – with Options

3.14. IGNITION FEED – RELAY 1, P. 12

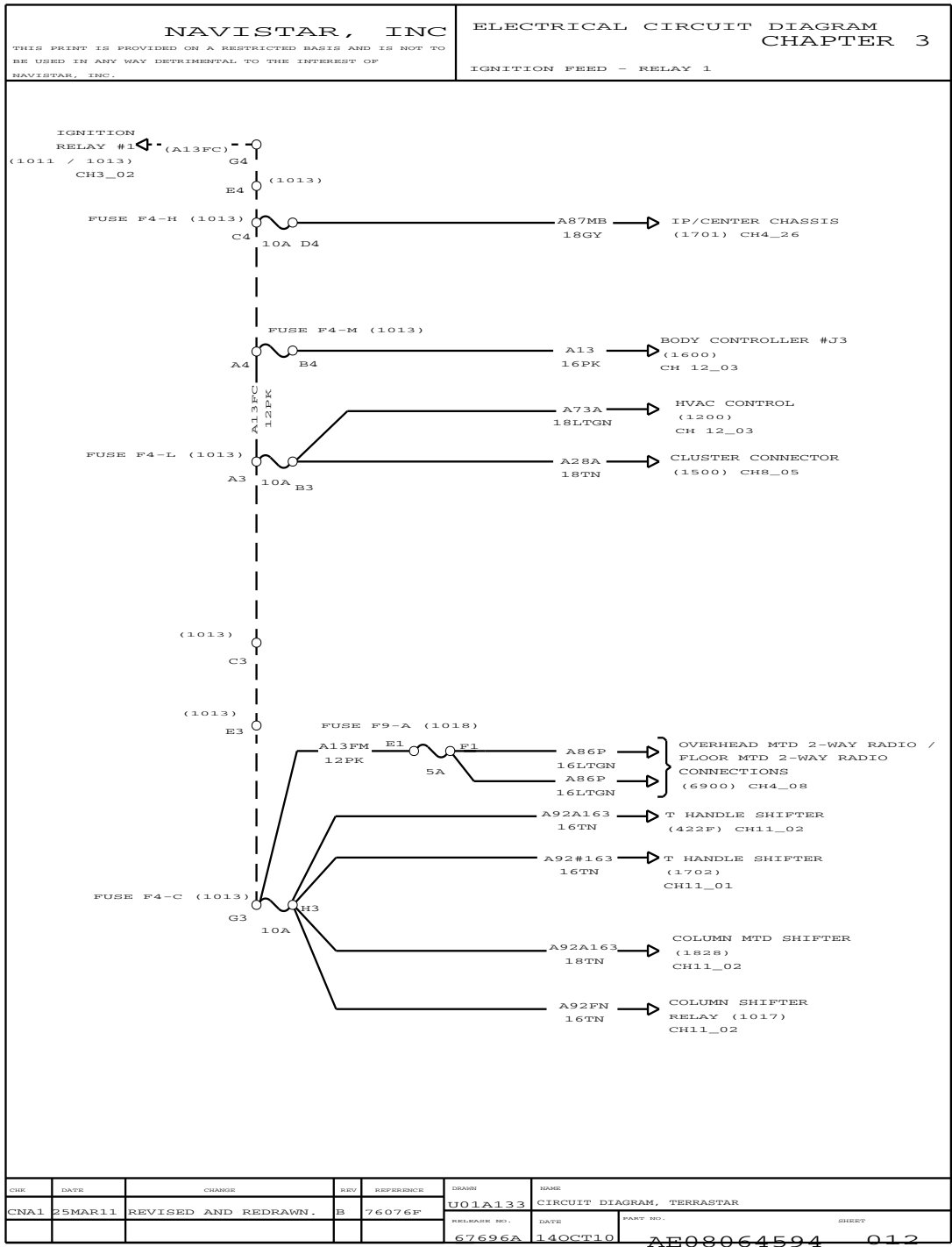

Figure 26 Ignition Feed – Relay 1

3.15. INTENTIONALLY LEFT BLANK, P. 13

<p>NAVISTAR, INC</p> <p><small>THIS PRINT IS PROVIDED ON A RESTRICTED BASIS AND IS NOT TO BE USED IN ANY WAY DETRIMENTAL TO THE INTEREST OF NAVISTAR, INC.</small></p>				<p>ELECTRICAL CIRCUIT DIAGRAM CHAPTER 3</p> <p>IGNITION FEED - RELAY 2</p>			
<p>INTENTIONALLY LEFT BLANK</p>							
CHR	DATE	CHANGE	REV	REFERENCE	DRAWN	NAME	
CNA1	25MAR11	REMOVED GEOMETRY.	B	76076P	U01A133	CIRCUIT DIAGRAM, TERRASTAR	
					RELEASE NO.	DATE	PART NO.
					67696A	15OCT10	AE08064594 013

Figure 27 Intentionally Left Blank

3.16. IGNITION FEED – RELAY 3, P. 14

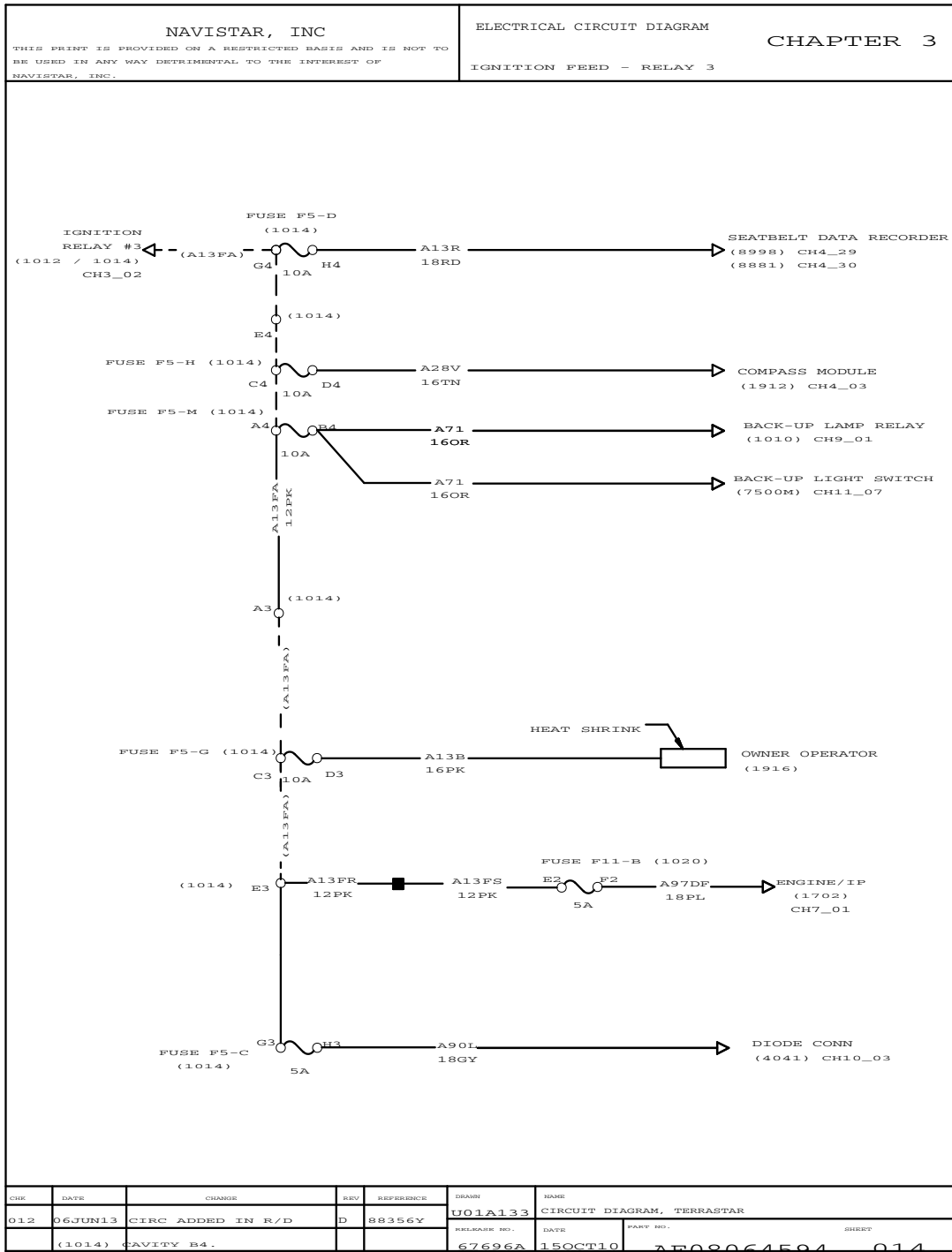

Figure 28 Ignition Feed – Relay 3

3.17. BATTERY FEED, DUAL, P. 15

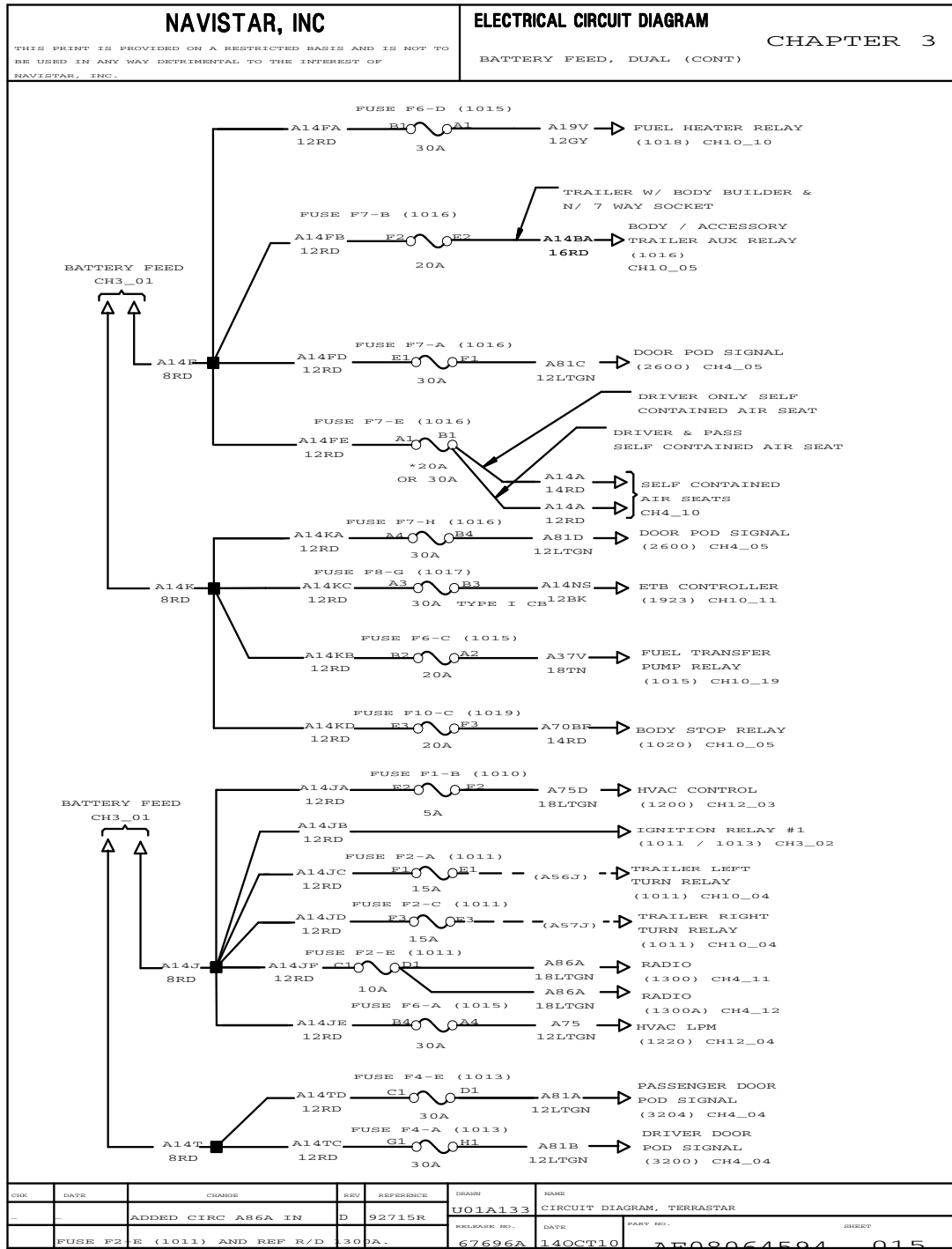

Figure 29 Battery Feed, Dual

3.18. BATTERY FEED, DUAL (CONT.), P. 16

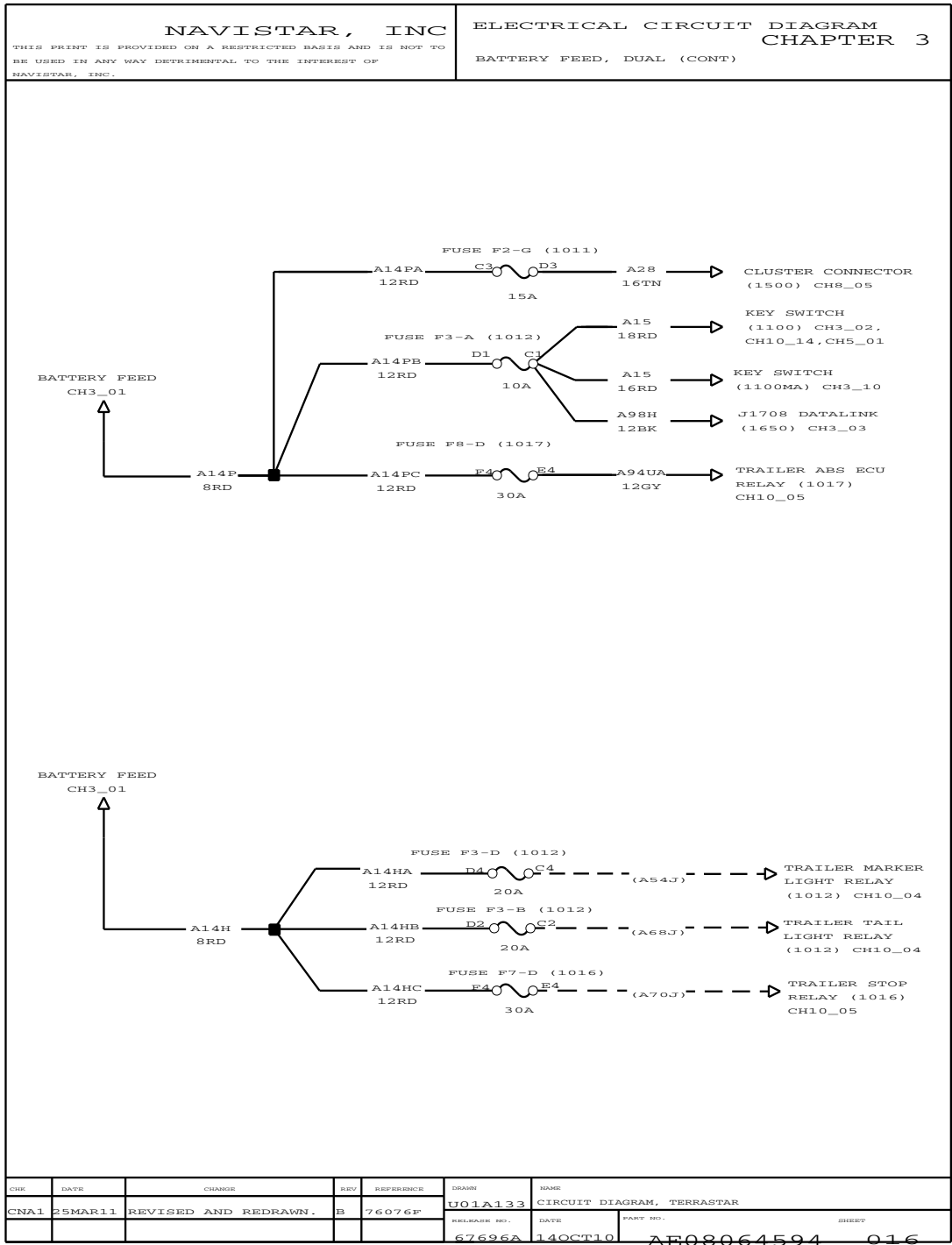

Figure 30 Battery Feed, Dual (Cont.)

3.19. BATTERY FEED, SINGLE, P. 17

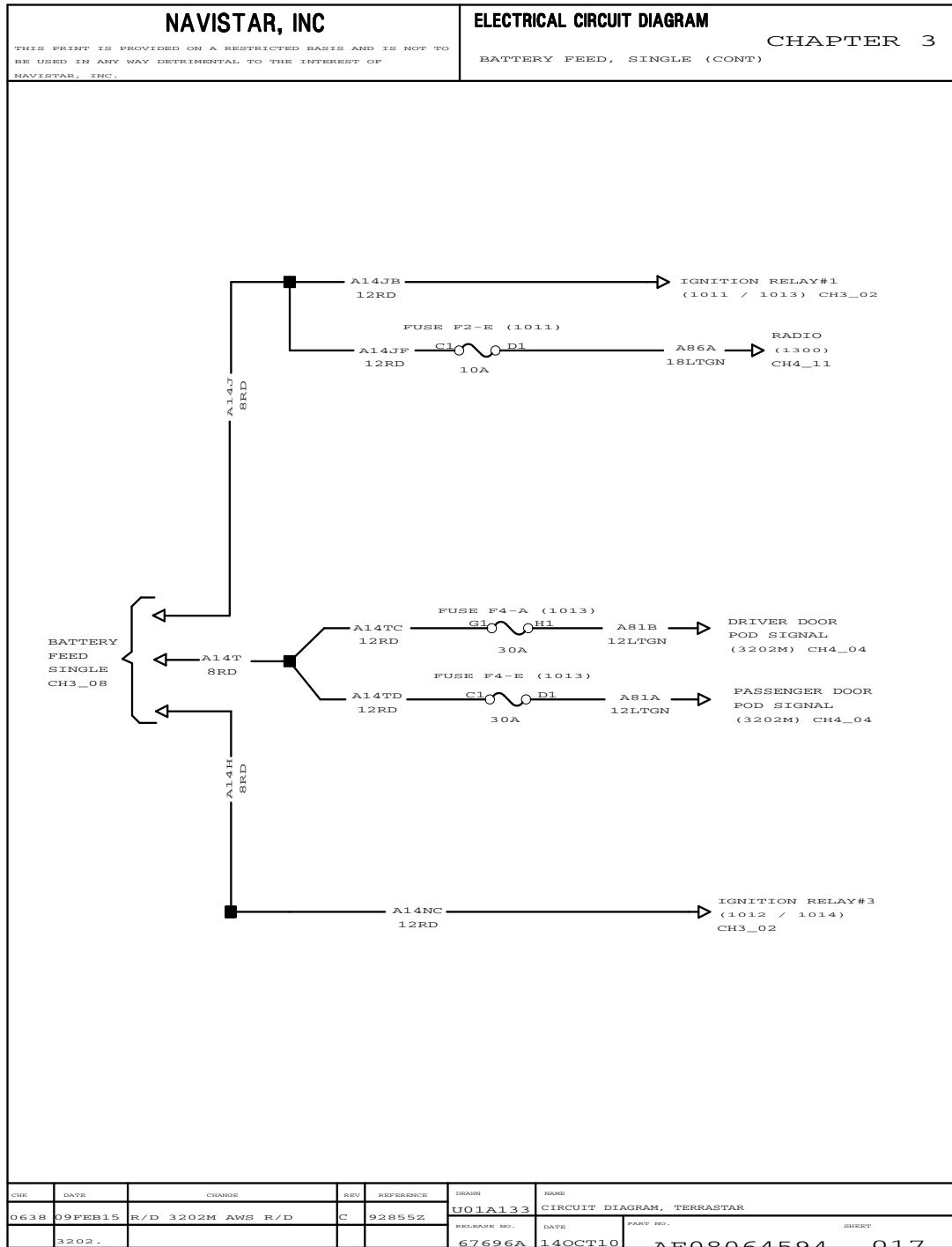

Figure 31 Battery Feed, Single

3.20. INTENTIONALLY LEFT BLANK, P. 18

NAVISTAR, INC <small>THIS PRINT IS PROVIDED ON A RESTRICTED BASIS AND IS NOT TO BE USED IN ANY WAY DETRIMENTAL TO THE INTEREST OF NAVISTAR, INC.</small>				ELECTRICAL CIRCUIT DIAGRAM CHAPTER 3 LATCHING RELAY			
<h1 style="margin: 0;">INTENTIONALLY LEFT BLANK</h1>							
CHR	DATE	CHANGE	REV	REFERENCE	DRAWN	NAME	
CNA1	25MAR11	REMOVED GEOMETRY.	B	76076P	U01A133	CIRCUIT DIAGRAM, TERRASTAR	
					RELEASE NO.	DATE	
					67696A	01NOV10	
					PART NO.	SHEET	
					AE08064594	018	

Figure 32 Intentionally Left Blank

3.21. GROUND – SEAT AND SEAT BELT SENSOR, P. 19

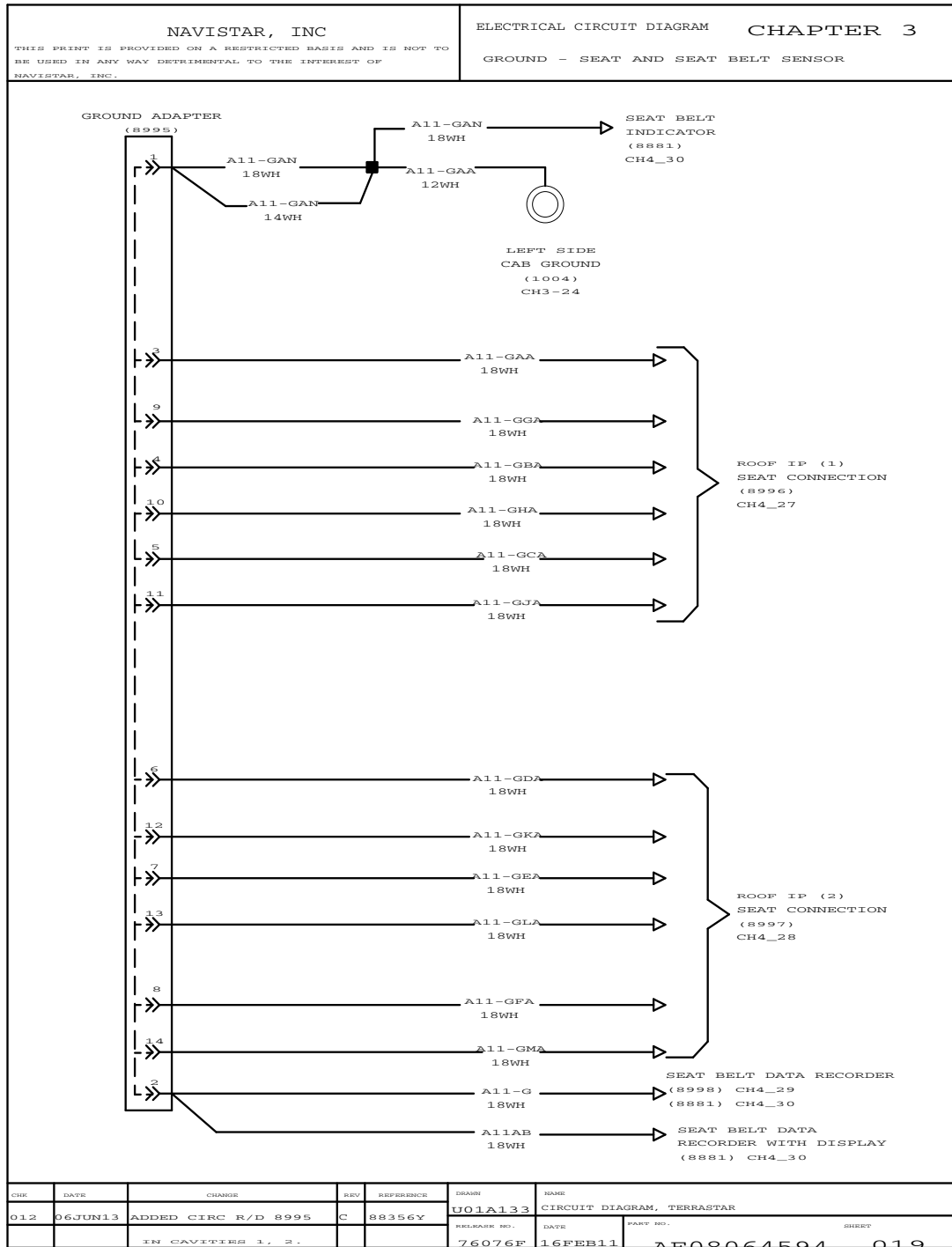

Figure 33 Ground – Seat and Seat Belt Sensor

3.22. GROUND – IP, P. 20

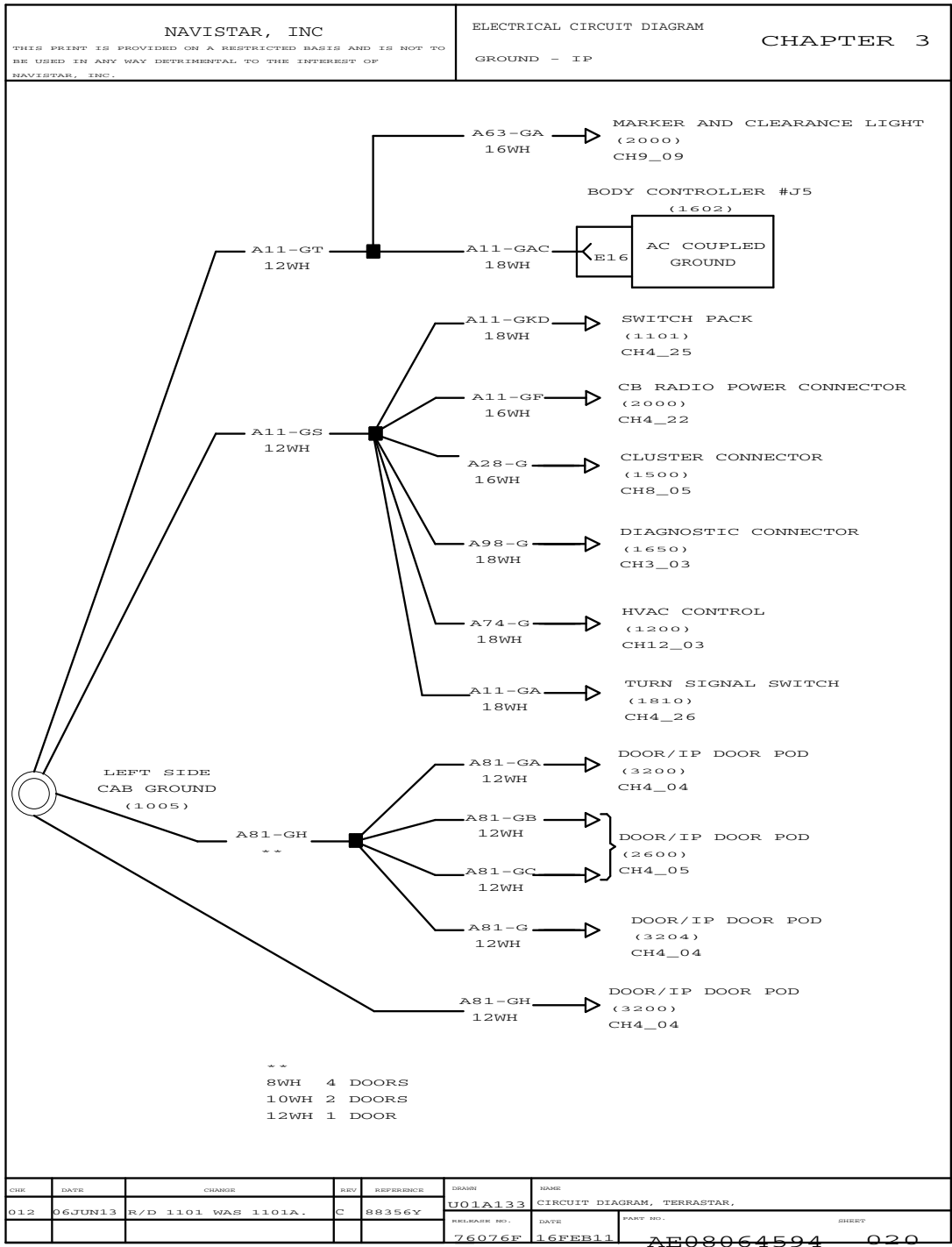

Figure 34 Ground – IP

3.23. GROUND – IP (CONT.), P. 21

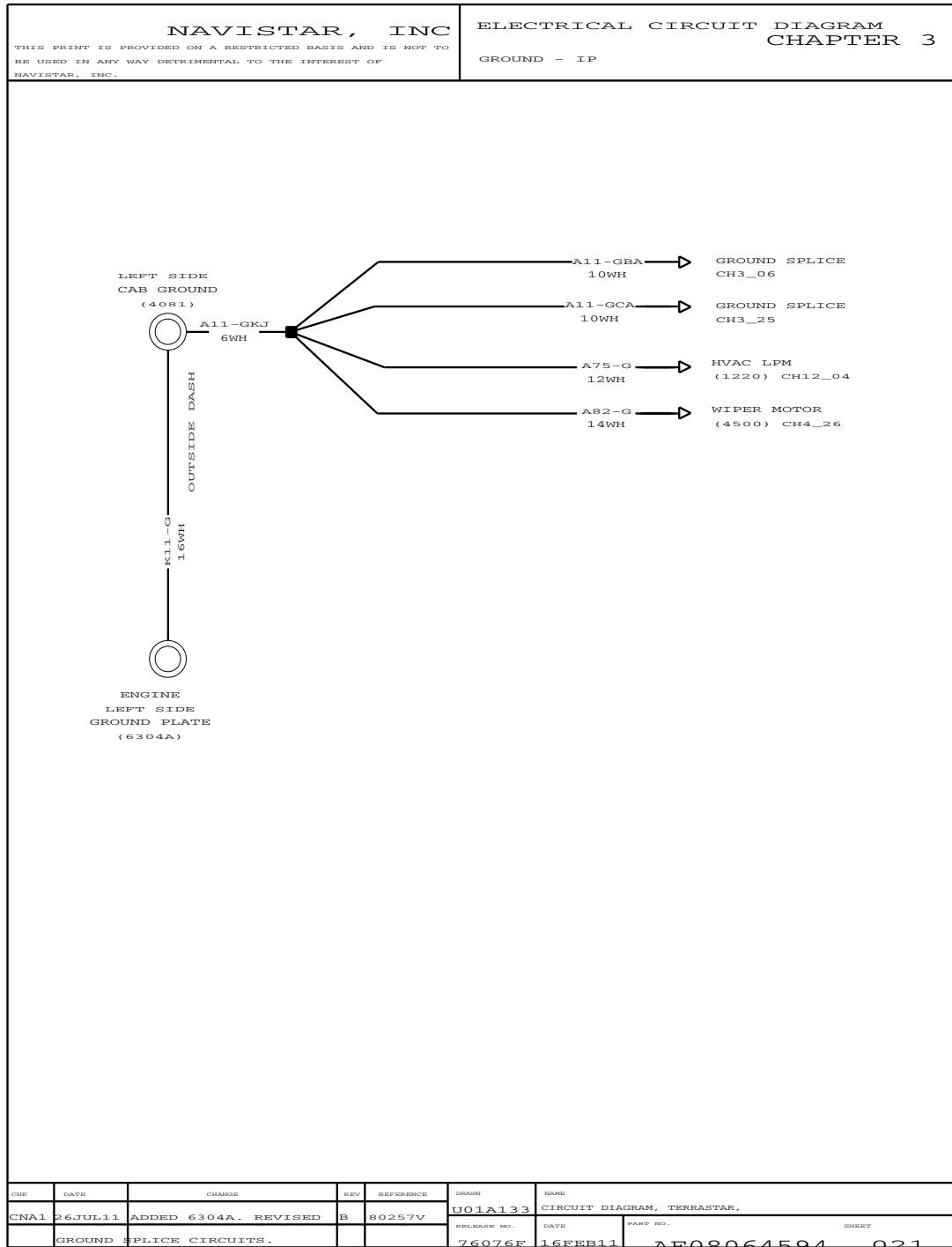

Figure 35 Ground – IP (Cont.)

3.24. GROUND – IP (CONT.), P. 22

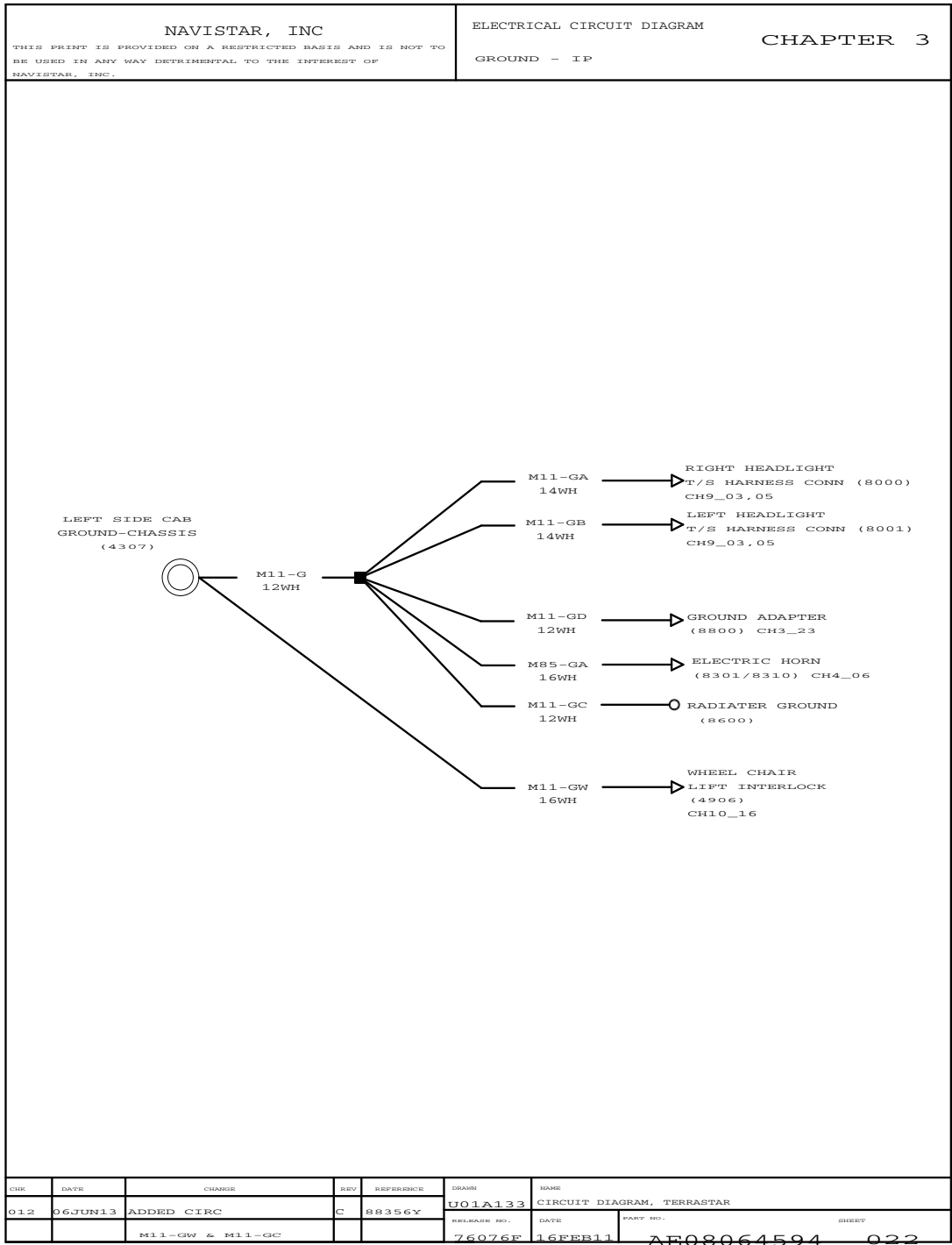

Figure 36 Ground – IP (Cont.)

3.25. GROUND – CHASSIS, P. 23

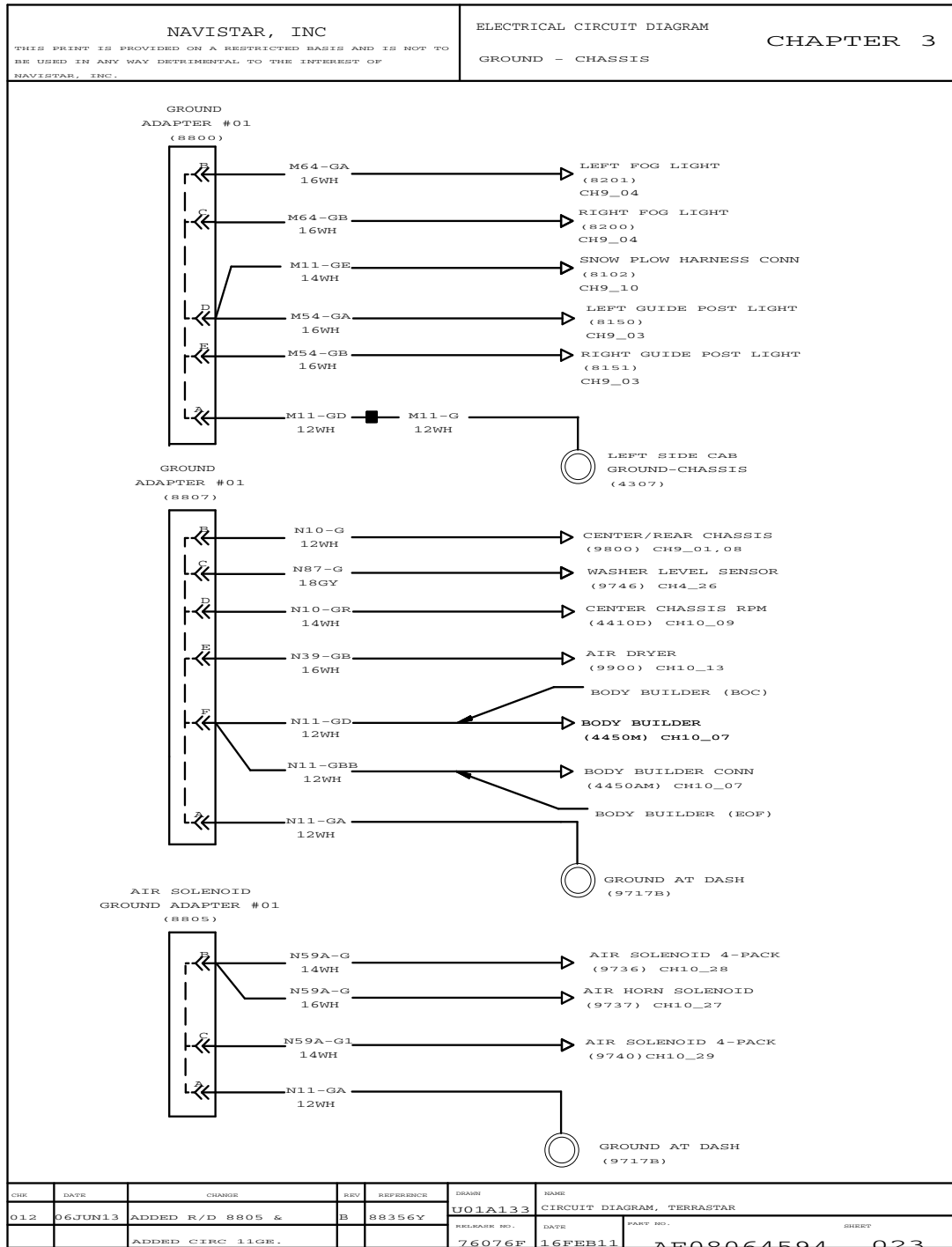

Figure 37 Ground – Chassis

3.26. GROUND – IP, P. 24

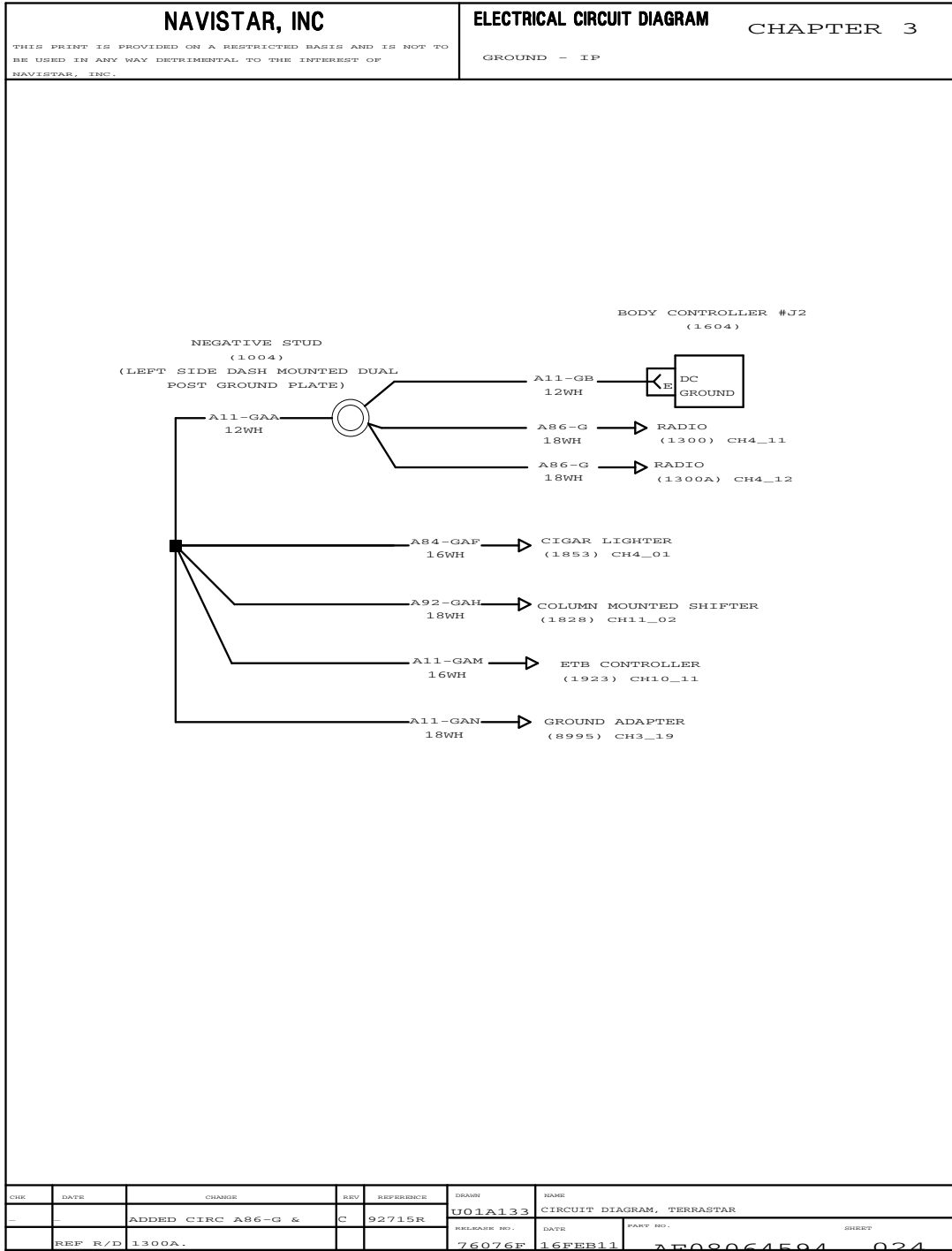

Figure 38 Ground – IP (Cont.)

3.27. GROUND – IP (CONT.), P. 25

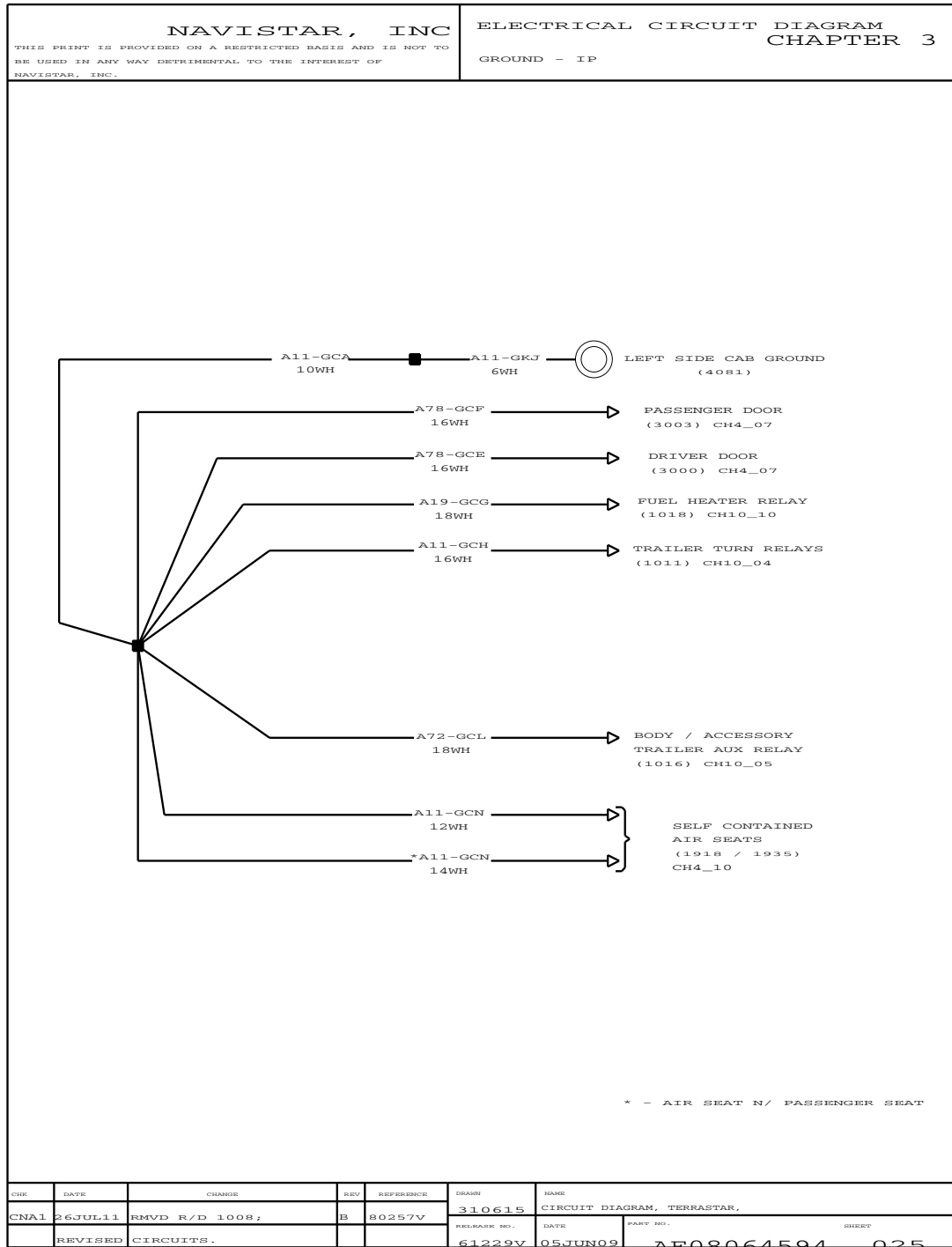

Figure 39 Ground – IP (Cont.)

3.28. GROUND – CHASSIS, P. 26

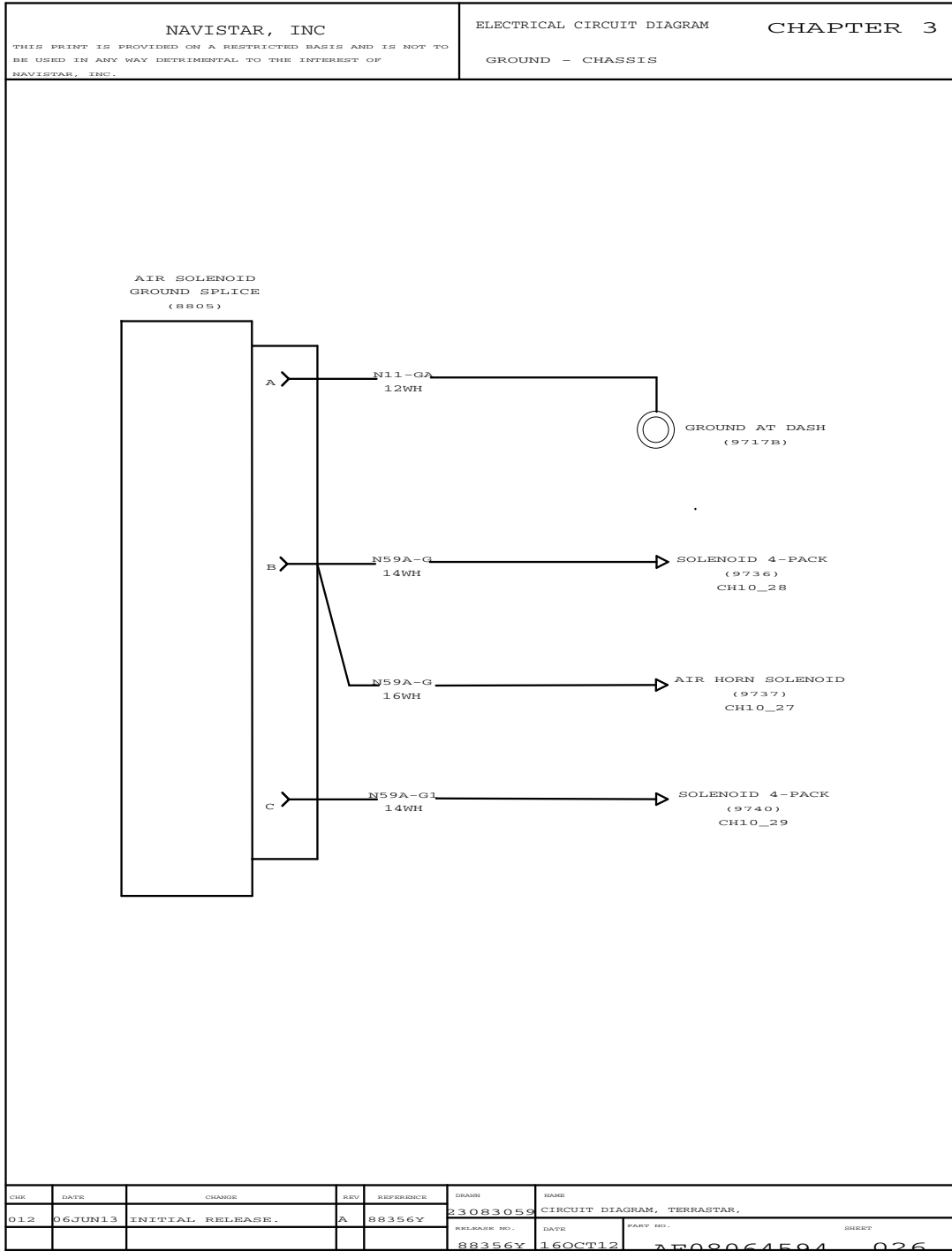

Figure 40 Ground – Chassis

3.29. INTENTIONALLY LEFT BLANK, P. 27

NAVISTAR, INC <small>THIS PRINT IS PROVIDED ON A RESTRICTED BASIS AND IS NOT TO BE USED IN ANY WAY DETRIMENTAL TO THE INTEREST OF NAVISTAR, INC.</small>				ELECTRICAL CIRCUIT DIAGRAM CHAPTER 3 INTENTIONALLY LEFT BLANK			
INTENTIONALLY LEFT BLANK							
CHK	DATE	CHANGE	REV	REFERENCE	DRAWN	NAME	
0610	07AUG13	INITIAL RELEASE.	A	92246F	MJV0088	CIRCUIT DIAGRAM, TERRASTAR.	
					RELEASE NO.	DATE	
					92246F	29JUL13	
						PART NO. SHEET	
						AE08064594 027	

Figure 41 Intentionally Left Blank

3.30. GROUND – TRAILER SOCKET AND FUEL PUMP, P. 28

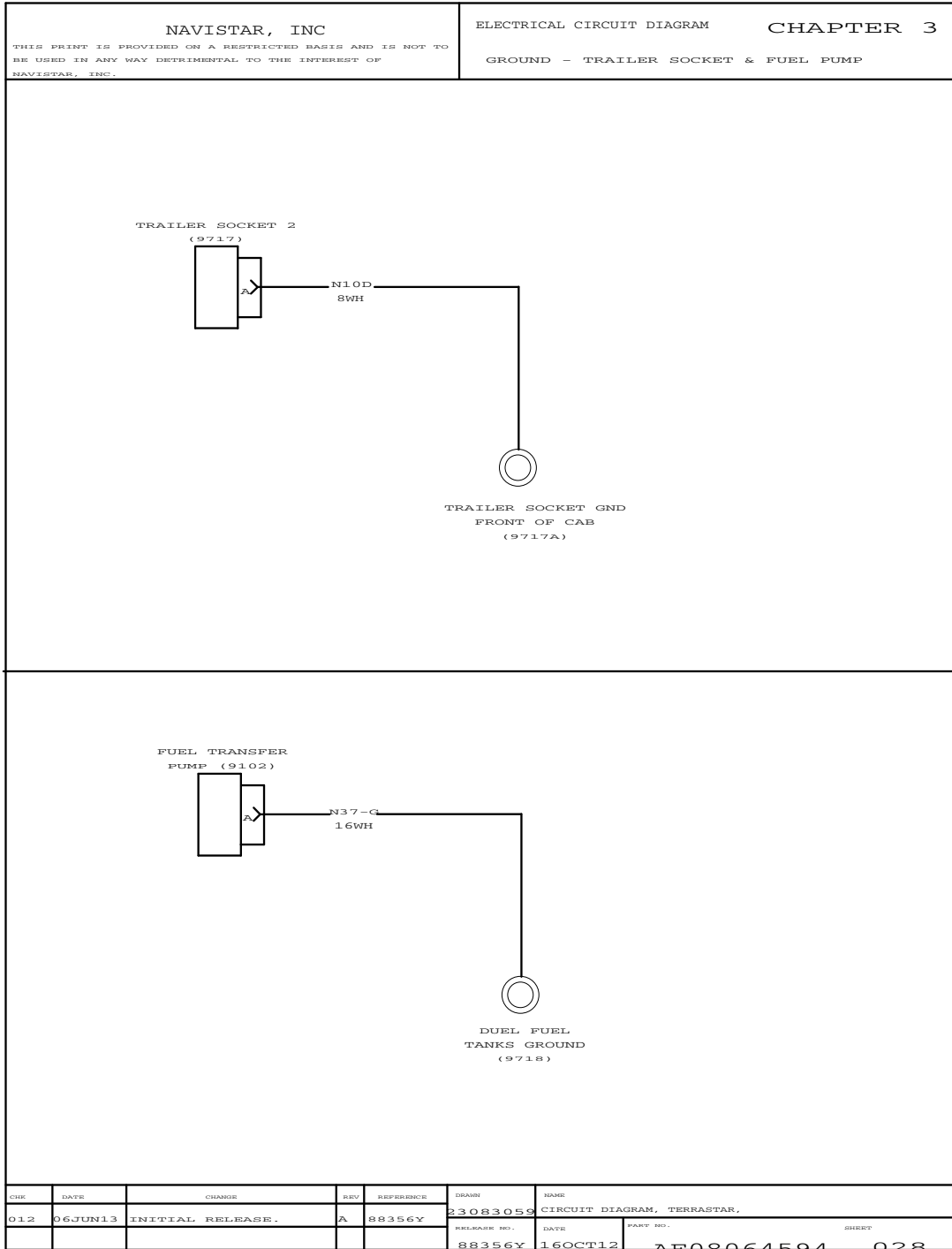

Figure 42 Ground – Trailer Socket and Fuel Pump

CAB ACCESSORIES (CHAPTER 4)

4.1. CIGAR LIGHTER AND POWER FEED, P. 1

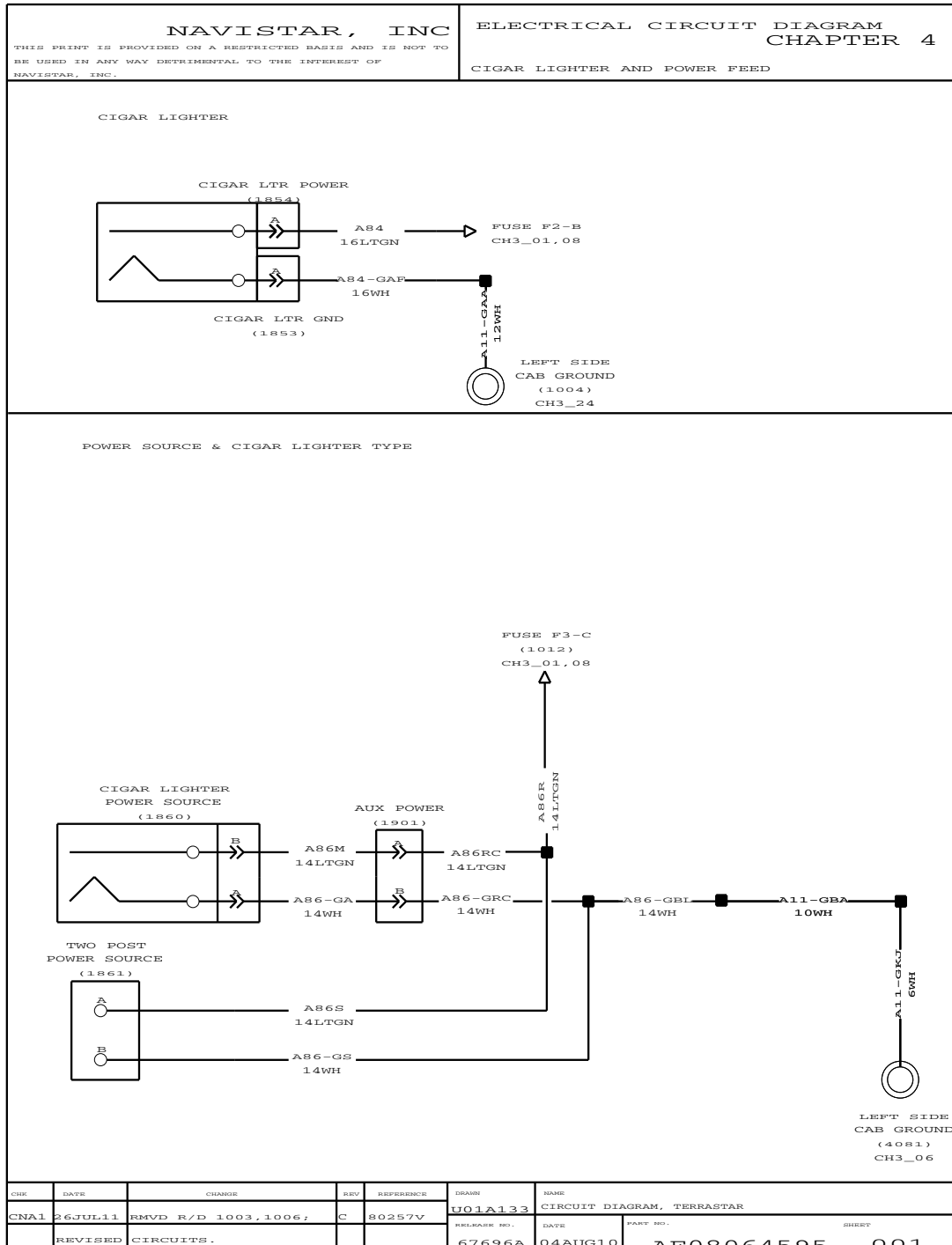

Figure 43 Cigar Lighter and Power Feed

4.2. CIGAR LIGHTER AND POWER FEED (CONT.), P. 2

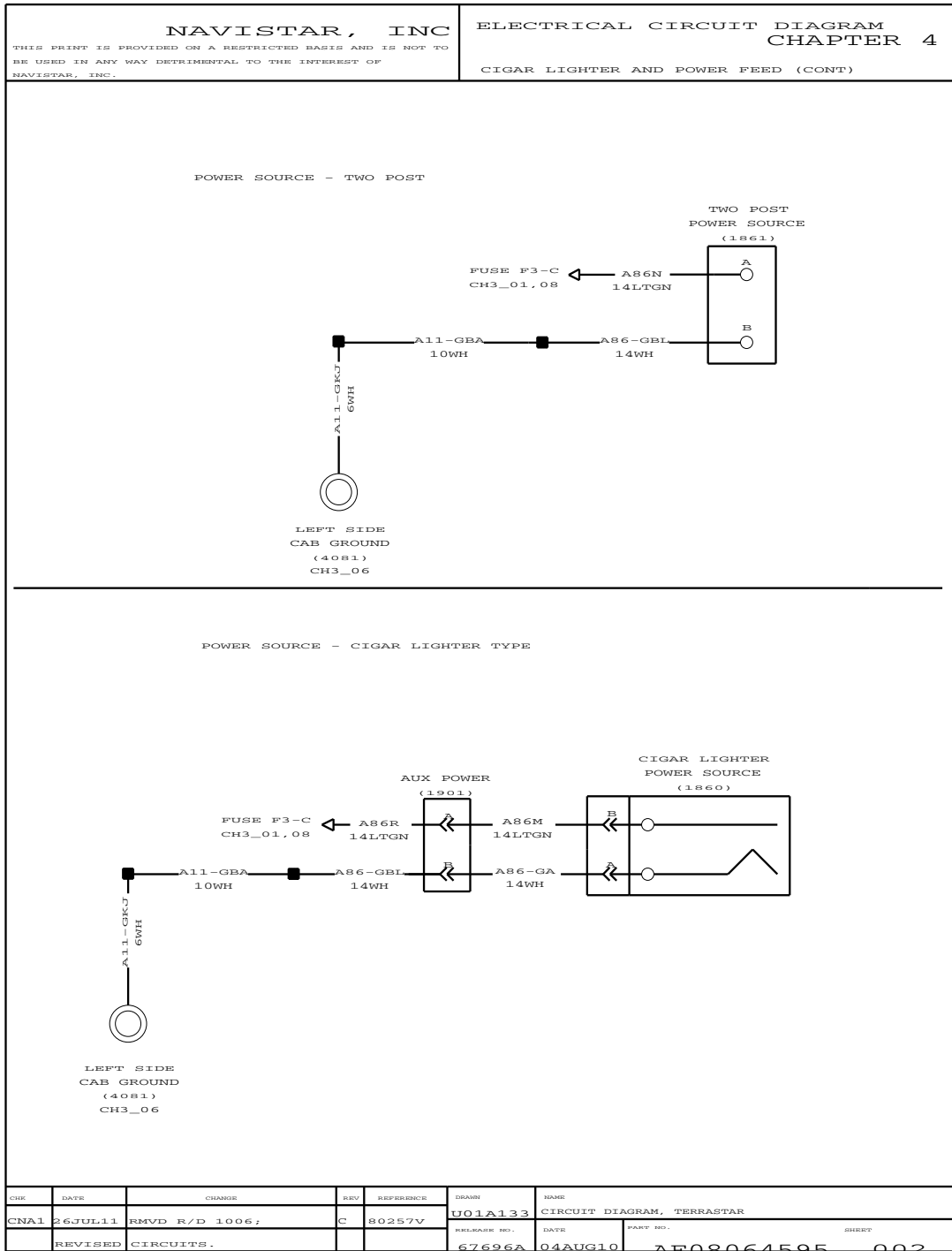

Figure 44 Cigar Lighter and Power Feed (Cont.)

4.3. COMPASS DISPLAY, P. 3

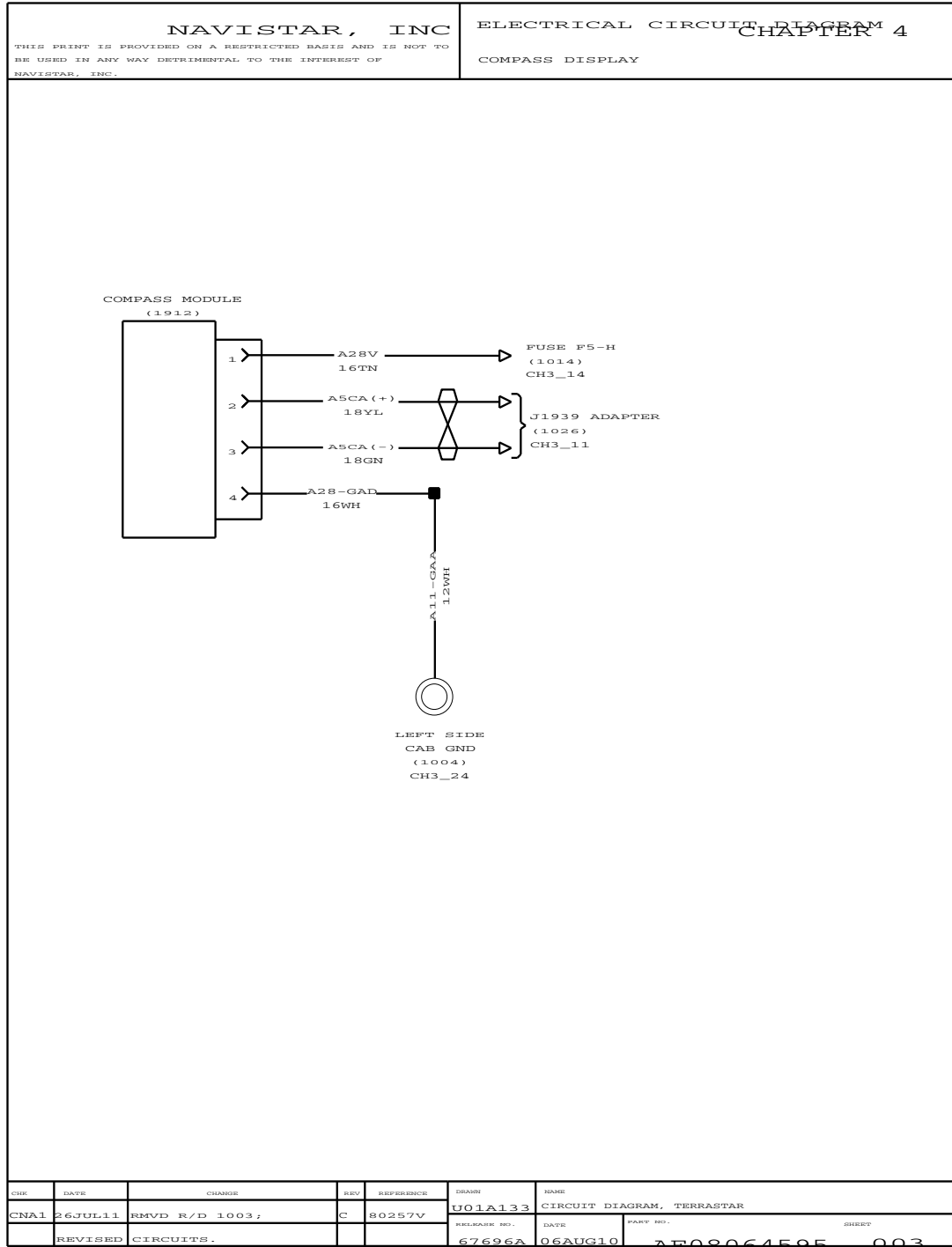

Figure 45 Compass Display

4.4. FRONT DOOR WINDOWS AND LOCKS (POWER), P. 4

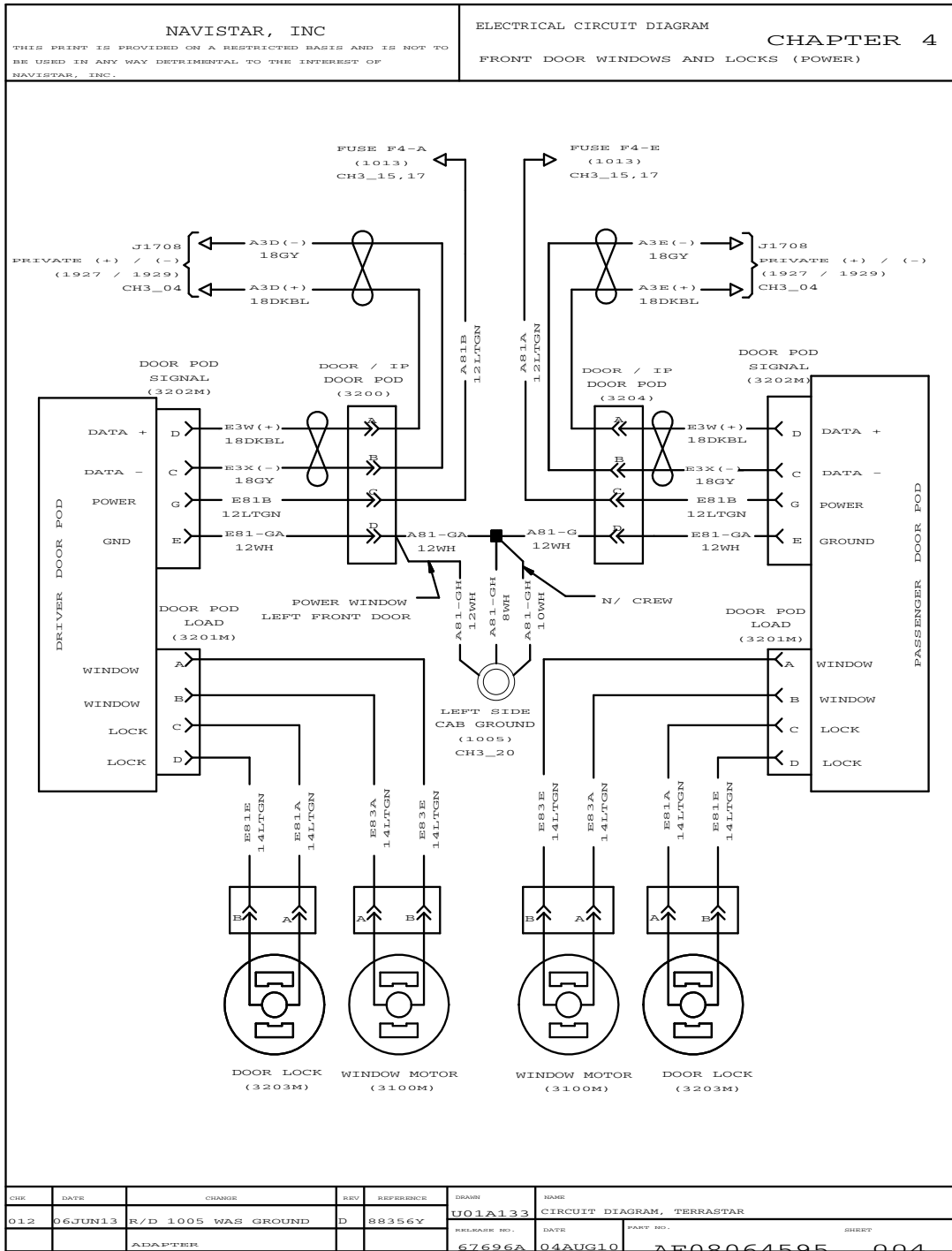

Figure 46 Front Door Windows and Locks (Power)

4.5. FRONT DOOR WINDOWS AND LOCKS (POWER) FOR CREW, P. 5

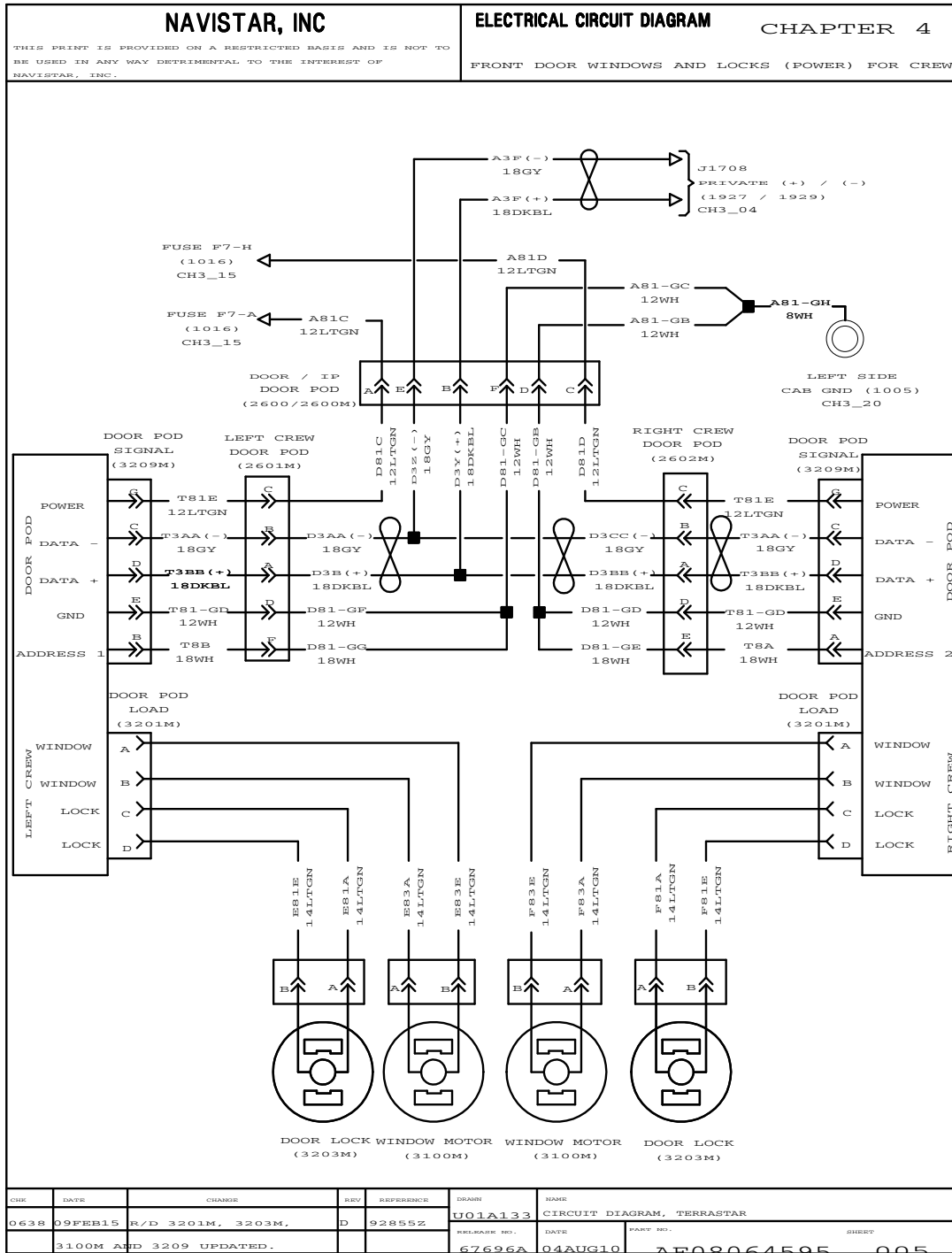

Figure 47 Front Door Windows and Locks (Power) For Crew

4.6. HORN – ELECTRIC AND AIR, P. 6

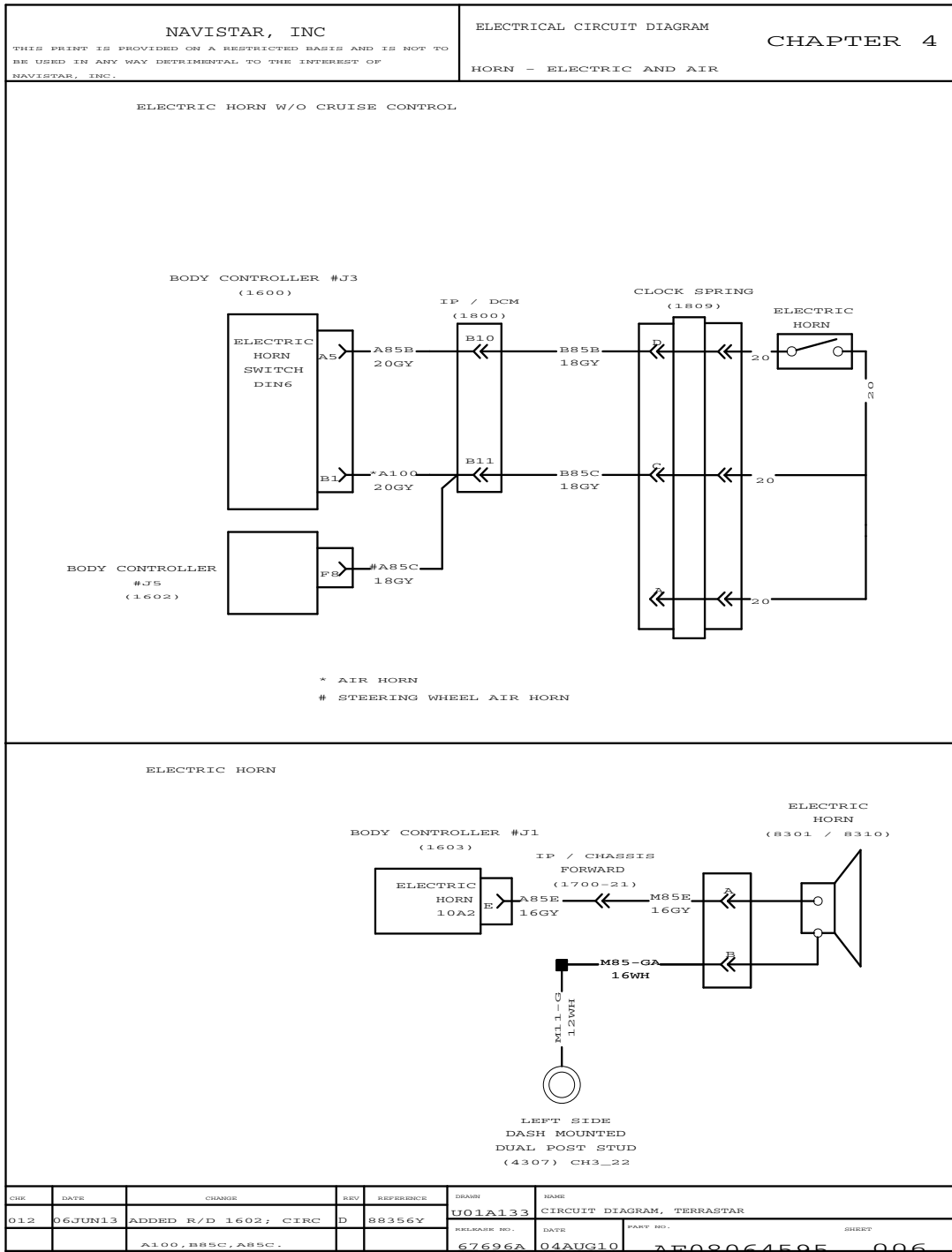

Figure 48 Horn – Electric and Air

4.8. 2 – WAY RADIO, P. 8

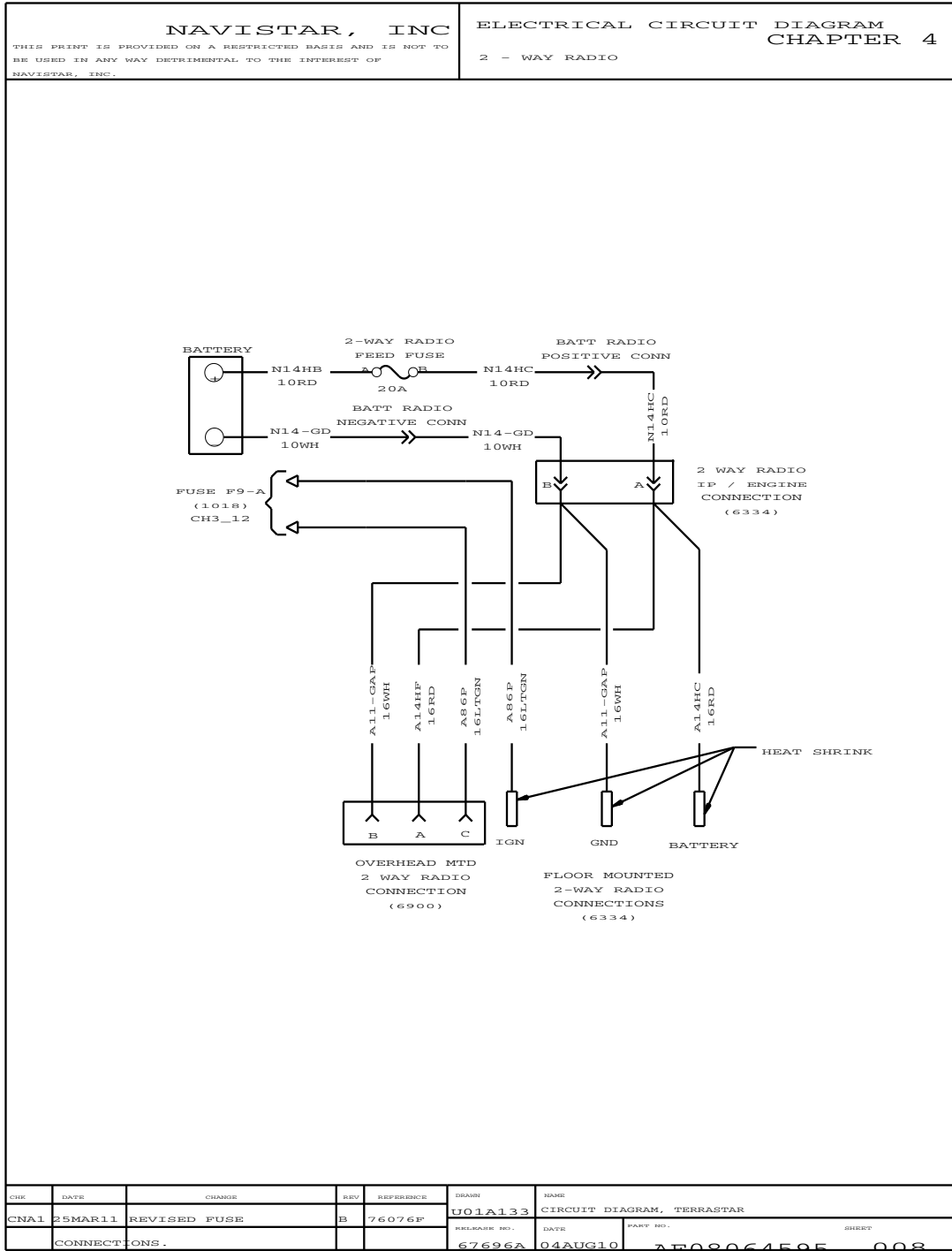

Figure 50 2 – Way Radio

4.9. INTENTIONALLY LEFT BLANK, P. 9

<p>NAVISTAR, INC</p> <p><small>THIS PRINT IS PROVIDED ON A RESTRICTED BASIS AND IS NOT TO BE USED IN ANY WAY DETRIMENTAL TO THE INTEREST OF NAVISTAR, INC.</small></p>				<p>ELECTRICAL CIRCUIT DIAGRAM CHAPTER 4</p> <p>WASHER PUMP</p>			
<p>INTENTIONALLY LEFT BLANK</p>							
CHR	DATE	CHANGE	REV	REFERENCE	DRAWN	NAME	
CNA1	25MAR11	REMOVED GEOMETRY.	B	76076P	U01A133	CIRCUIT DIAGRAM, TERRASTAR	
					RELEASE NO.	DATE	
					67696A	04AUG10	
						PART NO.	
						AE08064595	
						SHEET	
						009	

Figure 51 Intentionally Left Blank

4.10. SELF CONTAINED AIR SEAT, P. 10

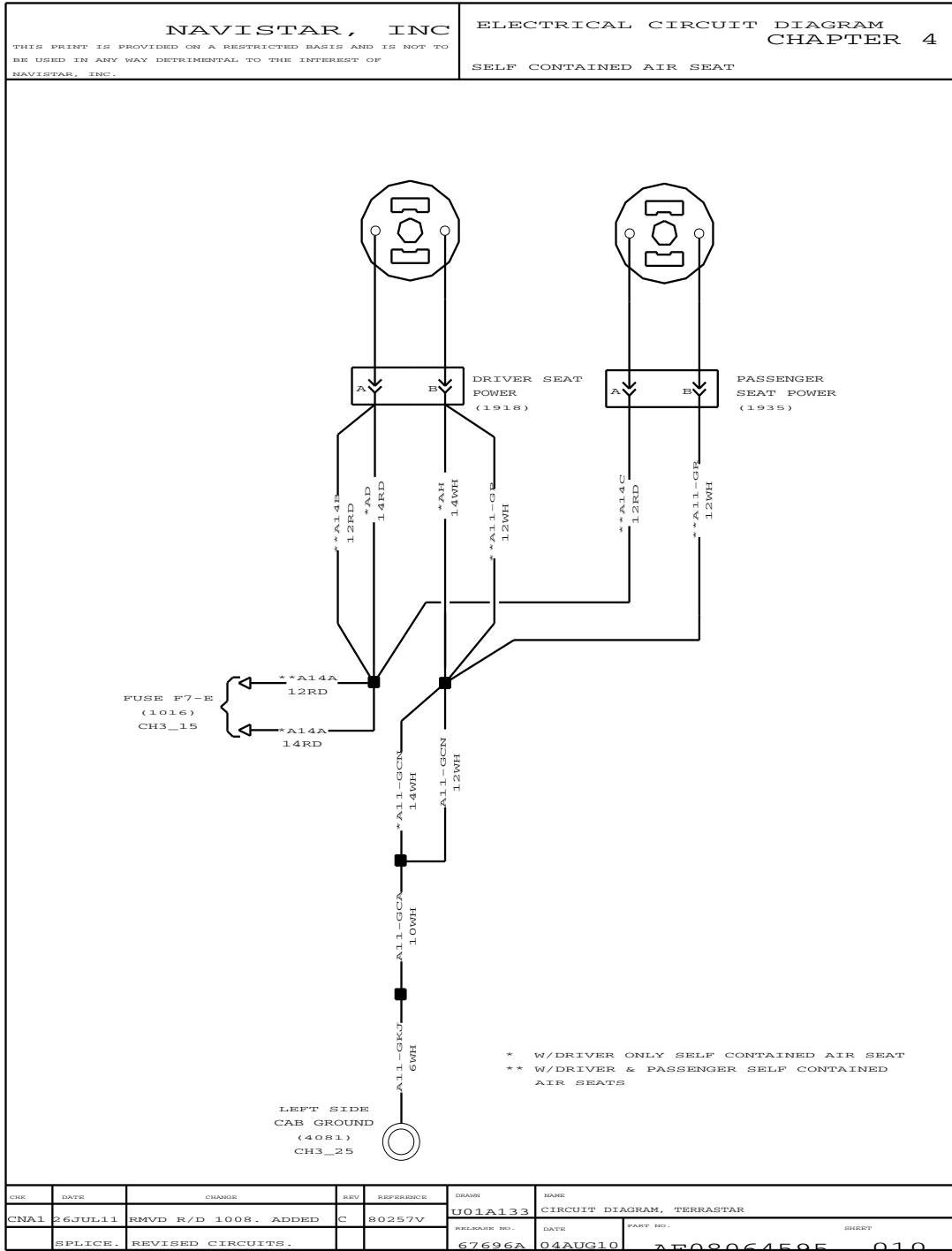

Figure 52 Self Contained Air Seat

4.11. RADIO (ENTERTAINMENT) SPEAKERS – WITH 16 WAY CONNECTOR, P. 11

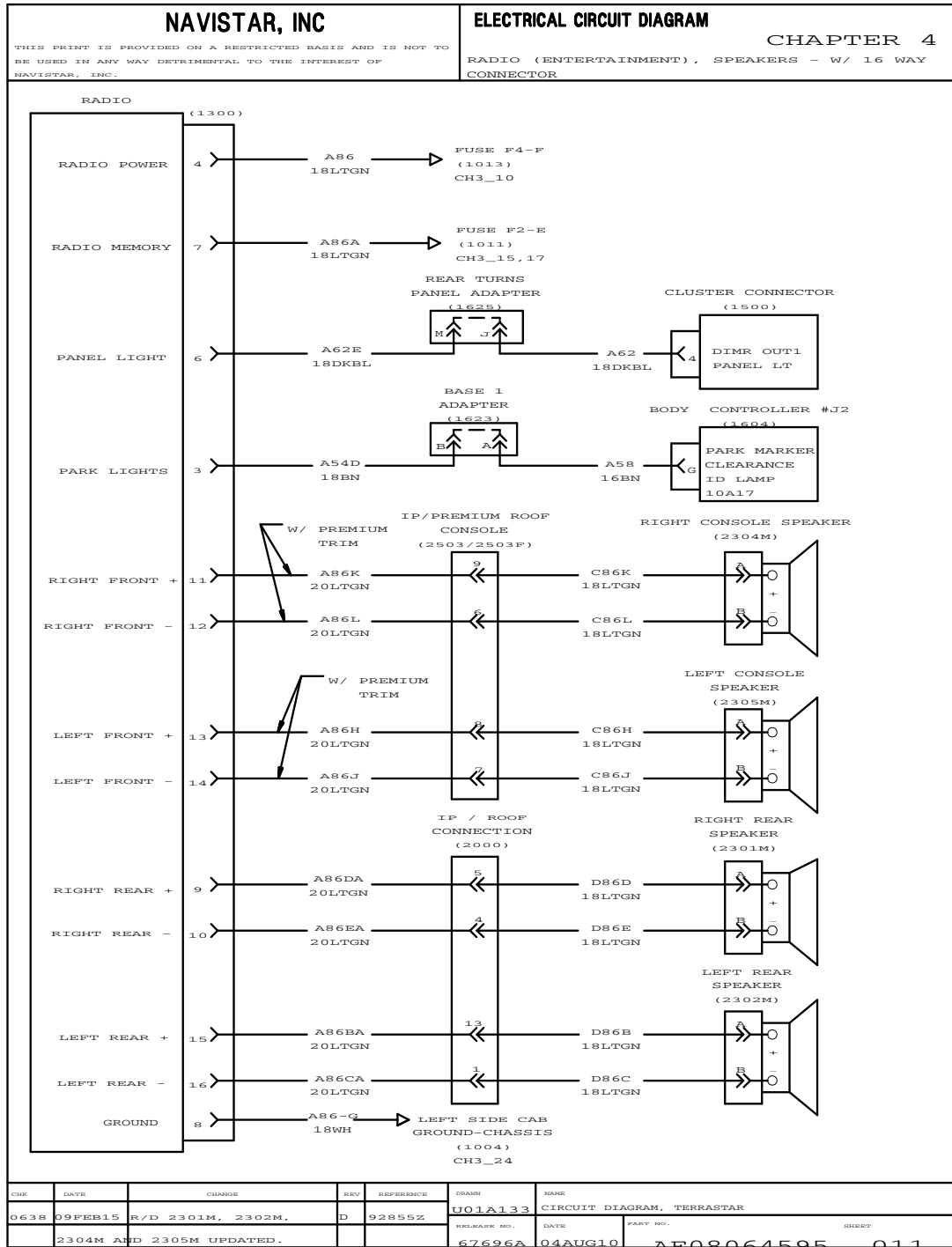

Figure 53 Radio (Entertainment) Speakers – with 16 Way Connector

4.12. RADIO (ENTERTAINMENT) SPEAKERS – WITH 12 WAY CONNECTOR, P. 11A

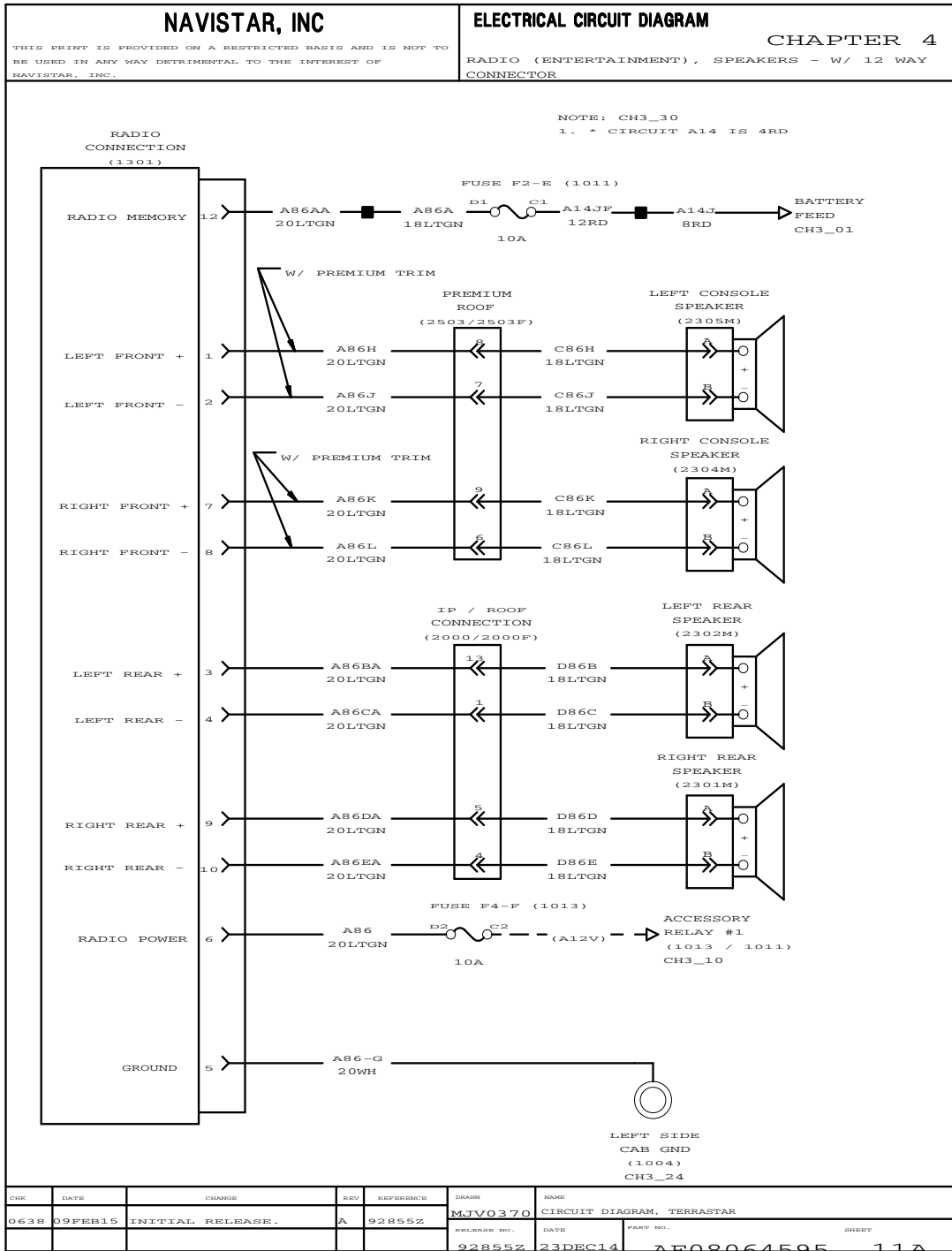

Figure 54 Radio (Entertainment) Speakers – with 12 Way Connector

4.13. RADIO (ENTERTAINMENT), SPEAKERS – WITH 16 WAY CONNECTOR (CONT.), P. 12

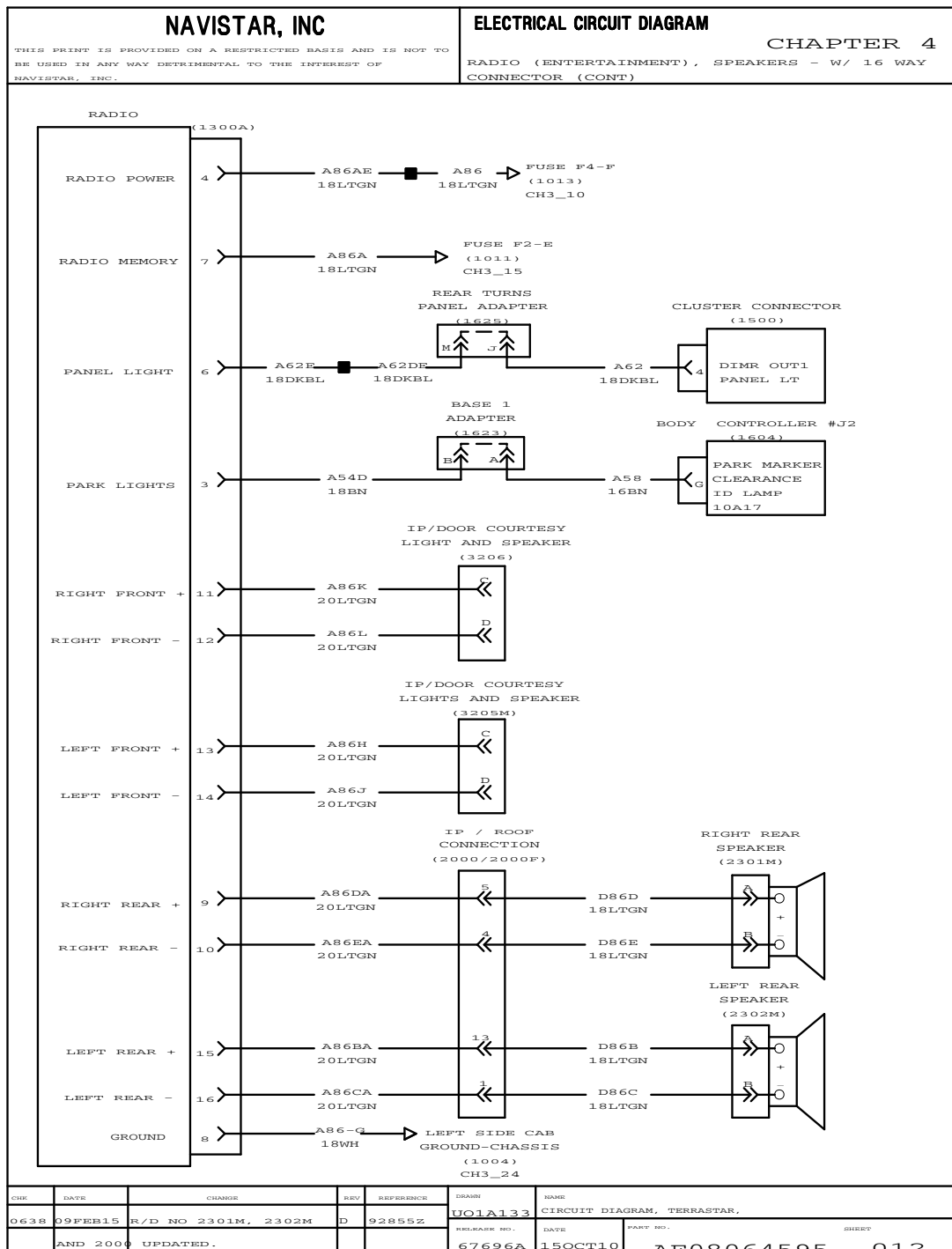

Figure 55 Radio (Entertainment), Speakers – with 16 Way Connector (Cont.)

4.14. INTENTIONALLY LEFT BLANK, P. 13

NAVISTAR, INC <small>THIS PRINT IS PROVIDED ON A RESTRICTED BASIS AND IS NOT TO BE USED IN ANY WAY DETRIMENTAL TO THE INTEREST OF NAVISTAR, INC.</small>				ELECTRICAL CIRCUIT DIAGRAM CHAPTER 4 COMPUTER PREWIRED - XATA SYSTEM			
<h1 style="margin: 0;">INTENTIONALLY LEFT BLANK</h1>							
CHR	DATE	CHANGE	REV	REFERENCE	DRAWN	NAME	
CNA1	25MAR11	REMOVED GEOMETRY.	B	76076P	U01A133	CIRCUIT DIAGRAM, TERRASTAR	
					RELEASE NO.	DATE	
					67696A	15OCT10	
						PART NO.	
						AE08064595	
						SHEET	
						013	

Figure 56 Intentionally Left Blank

4.15. INTENTIONALLY LEFT BLANK, P. 14

NAVISTAR, INC <small>THIS PRINT IS PROVIDED ON A RESTRICTED BASIS AND IS NOT TO BE USED IN ANY WAY DETRIMENTAL TO THE INTEREST OF NAVISTAR, INC.</small>				ELECTRICAL CIRCUIT DIAGRAM CHAPTER 4 CADEC GPS SYSTEM			
<p>INTENTIONALLY LEFT BLANK</p>							
CHK	DATE	CHANGE	REV	REFERENCE	DRAWN	NAME	
CNA1	25MAR11	REMOVED GEOMETRY.	B	76076P	U01A133	CIRCUIT DIAGRAM, TERRASTAR	
					RELEASE NO.	DATE	PART NO.
					67696A	15OCT10	AE08064595 014

Figure 57 Intentionally Left Blank

4.16. INTENTIONALLY LEFT BLANK, P. 15

<p>NAVISTAR, INC</p> <p>THIS PRINT IS PROVIDED ON A RESTRICTED BASIS AND IS NOT TO BE USED IN ANY WAY DETRIMENTAL TO THE INTEREST OF NAVISTAR, INC.</p>				<p>ELECTRICAL CIRCUIT DIAGRAM CHAPTER 4</p> <p>SATELLITE COMMUNICATION - TRIPMASTER</p>			
<p>INTENTIONALLY LEFT BLANK</p>							
CHK	DATE	CHANGE	REV	REFERENCE	DRAWN	NAME	
					U01A133	CIRCUIT DIAGRAM, TERRASTAR	
CNA1	25MAR11	REMOVED GEOMETRY.	B	76076P	67696A	15OCT10	
						AE08064595 015	

Figure 58 Intentionally Left Blank

4.17. INTENTIONALLY LEFT BLANK, P. 16

NAVISTAR, INC <small>THIS PRINT IS PROVIDED ON A RESTRICTED BASIS AND IS NOT TO BE USED IN ANY WAY DETRIMENTAL TO THE INTEREST OF NAVISTAR, INC.</small>				ELECTRICAL CIRCUIT DIAGRAM CHAPTER 4 SATELLITE COMMUNICATION - QUALCOMM IMCT			
<h1 style="margin: 0;">INTENTIONALLY LEFT BLANK</h1>							
<small>CHR</small>	<small>DATE</small>	<small>CHANGE</small>	<small>REV</small>	<small>REFERENCE</small>	<small>DRAWN</small>	<small>NAME</small>	
CNA1	25MAR11	REMOVED GEOMETRY.	B	76076P	U01A133	CIRCUIT DIAGRAM, TERRASTAR	
					<small>RELEASE NO.</small>	<small>DATE</small>	
					67696A	15OCT10	
						<small>PART NO.</small>	
						AE08064595	
						<small>SHEET</small>	
						016	

Figure 59 Intentionally Left Blank

4.18. ROOF AUX LOAD, P. 17

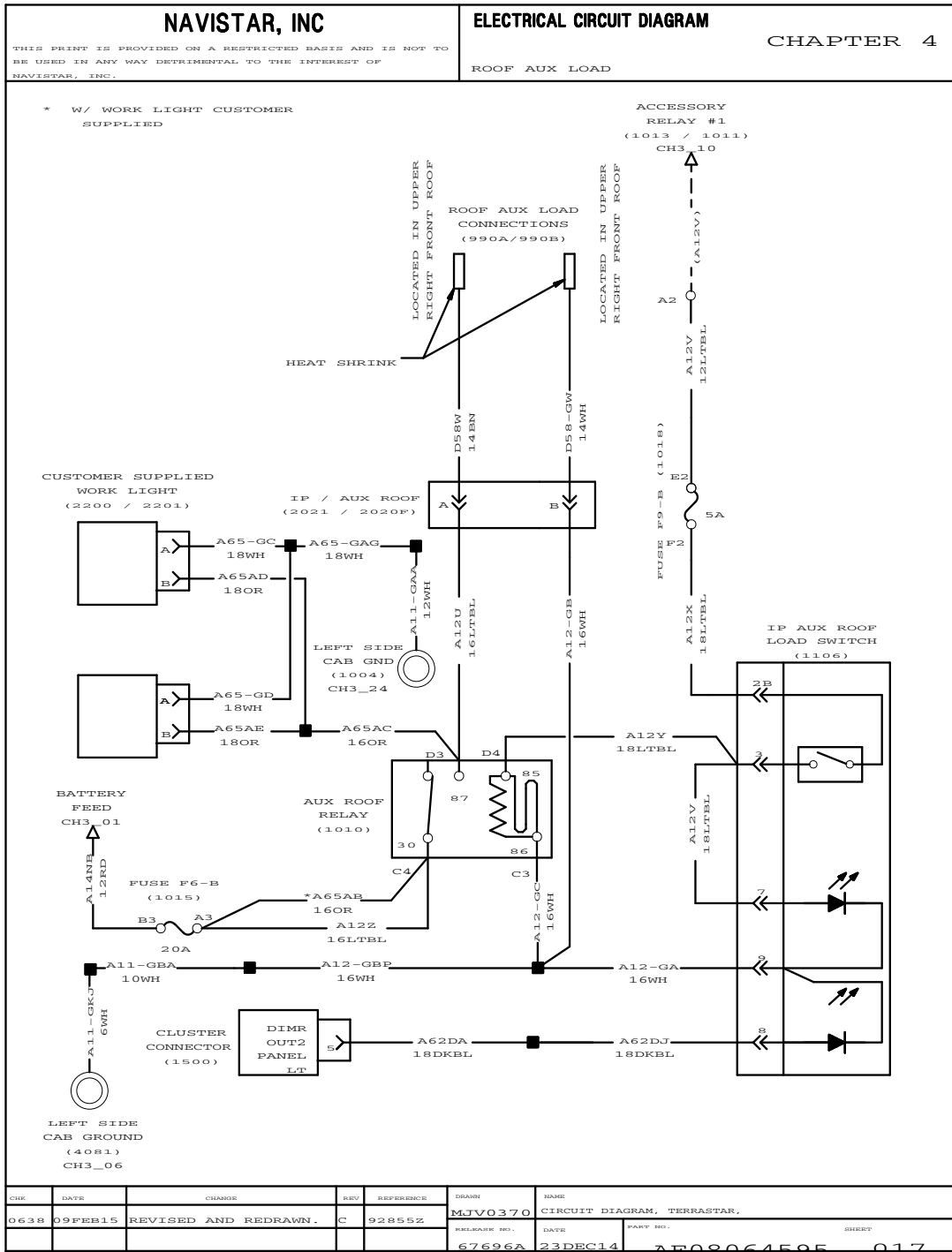

Figure 60 Roof Aux Load

4.19. INTENTIONALLY LEFT BLANK, P. 18

NAVISTAR, INC <small>THIS PRINT IS PROVIDED ON A RESTRICTED BASIS AND IS NOT TO BE USED IN ANY WAY DETRIMENTAL TO THE INTEREST OF NAVISTAR, INC.</small>				ELECTRICAL CIRCUIT DIAGRAM CHAPTER 4 MIRRORS (HEATED, LIGHTED & POWER) (CONT)			
<h1 style="margin: 0;">INTENTIONALLY LEFT BLANK</h1>							
CHR	DATE	CHANGE	REV	REFERENCE	DRAWN	NAME	
					U01A133	CIRCUIT DIAGRAM, TERRASTAR	
CNA1	25MAR11	REMOVED GEOMETRY.	B	76076P	RELEASE NO.	DATE	
					67696A	15OCT10	
					PART NO. SHEET		
					AE08064595 018		

Figure 61 Intentionally Left Blank

4.20. INTENTIONALLY LEFT BLANK, P. 19

NAVISTAR, INC <small>THIS PRINT IS PROVIDED ON A RESTRICTED BASIS AND IS NOT TO BE USED IN ANY WAY DETRIMENTAL TO THE INTEREST OF NAVISTAR, INC.</small>				ELECTRICAL CIRCUIT DIAGRAM CHAPTER 4 SATELLITE COMMUNICATION - QUALCOMM IMCT W/ MVPC KEYBOARD			
<p>INTENTIONALLY LEFT BLANK</p>							
CHR	DATE	CHANGE	REV	REFERENCE	DRAWN	NAME	
CNA1	25MAR11	REMOVED GEOMETRY.	B	76076P	U01A133	CIRCUIT DIAGRAM, TERRASTAR	
					RELEASE NO.	DATE	PART NO.
					67696A	15OCT10	AE08064595 019

Figure 62 Intentionally Left Blank

4.21. INTENTIONALLY LEFT BLANK, P. 20

<p>NAVISTAR, INC</p> <p><small>THIS PRINT IS PROVIDED ON A RESTRICTED BASIS AND IS NOT TO BE USED IN ANY WAY DETRIMENTAL TO THE INTEREST OF NAVISTAR, INC.</small></p>				<p>ELECTRICAL CIRCUIT DIAGRAM CHAPTER 4</p> <p>SATELLITE COMMUNICATION - QUALCOMM OMNIVISION</p>			
<p>INTENTIONALLY LEFT BLANK</p>							
<small>CHR</small>	<small>DATE</small>	<small>CHANGE</small>	<small>REV</small>	<small>REFERENCE</small>	<small>DRAWN</small>	<small>NAME</small>	
CNA1	25MAR11	REMOVED GEOMETRY.	B	76076P	U01A133	CIRCUIT DIAGRAM, TERRASTAR	
					<small>RELEASE NO.</small>	<small>DATE</small>	<small>PART NO.</small>
					67696A	15OCT10	AE08064595 020

Figure 63 Intentionally Left Blank

4.22. MIRRORS (HEATED, LIGHTED & POWER) , P. 21

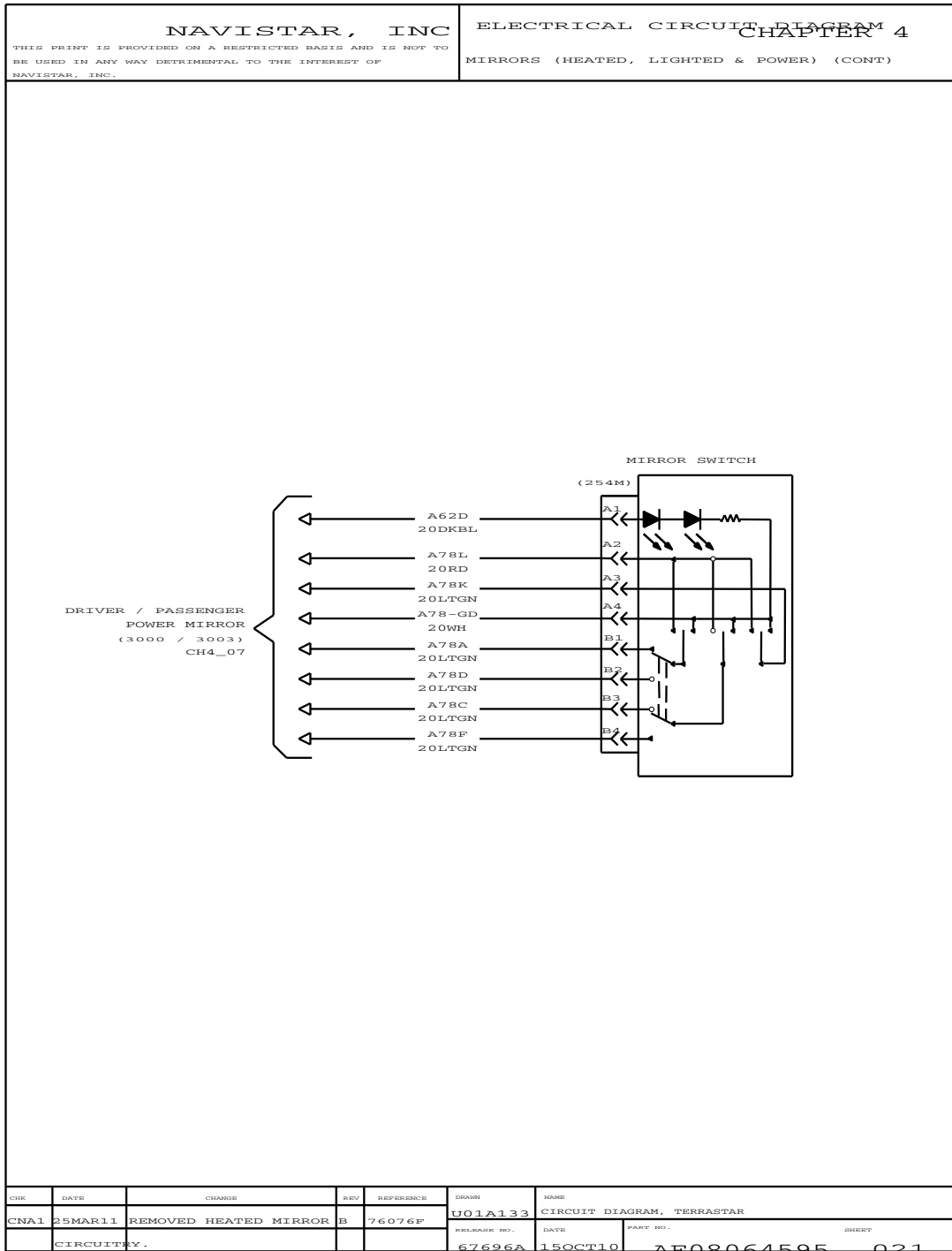

Figure 64 Mirrors (Heated, Lighted & Power)

4.23. CB POWER RADIO, P. 22

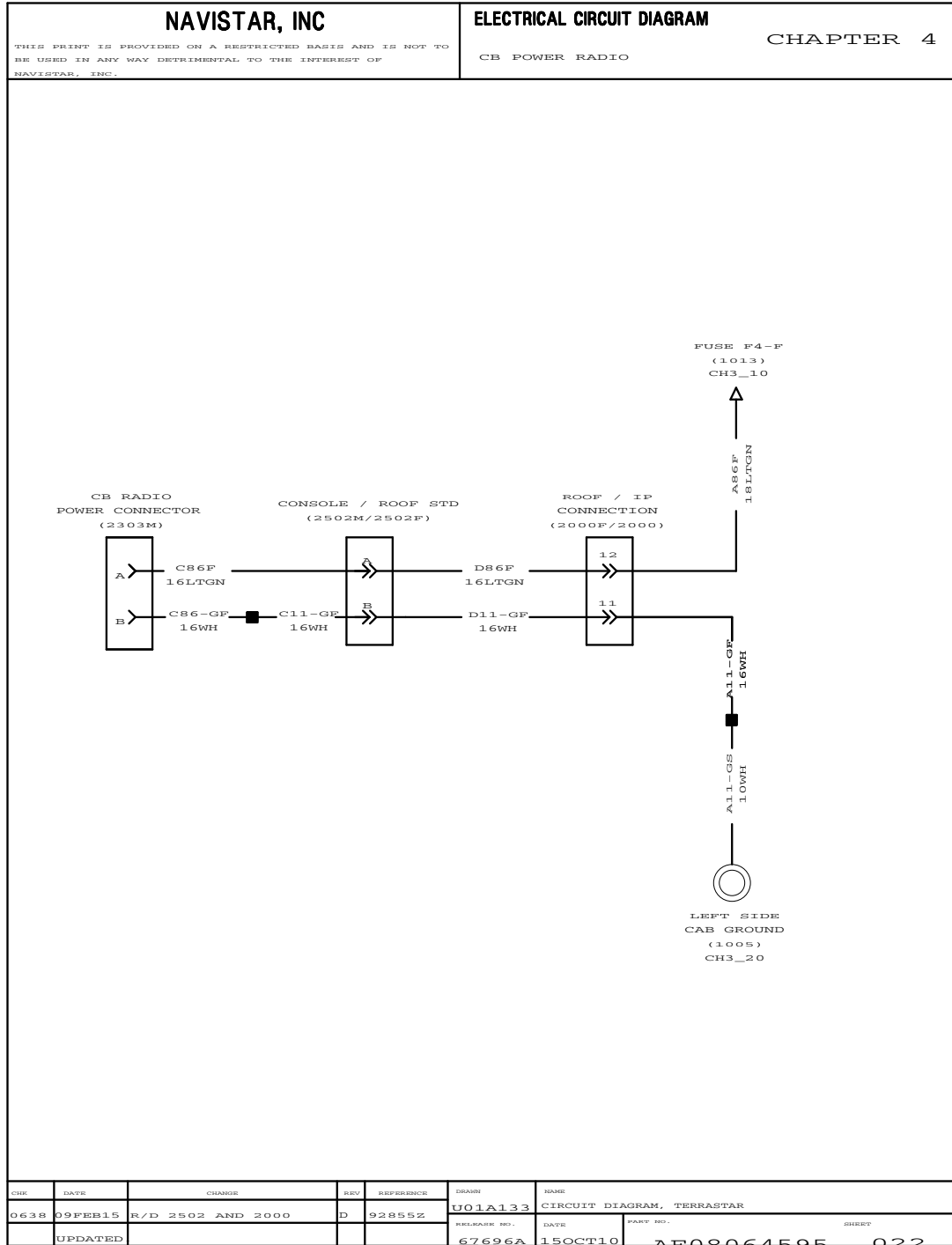

Figure 65 CB Power Radio

4.24. BACK-UP CAMERA, P. 23

NAVISTAR, INC <small>THIS PRINT IS PROVIDED ON A RESTRICTED BASIS AND IS NOT TO BE USED IN ANY WAY DETRIMENTAL TO THE INTEREST OF NAVISTAR, INC.</small>				ELECTRICAL CIRCUIT DIAGRAM CHAPTER 4 BACK-UP CAMERA			
<p>INTENTIONALLY LEFT BLANK</p>							
CHK	DATE	CHANGE	REV	REFERENCE	DRAWN	NAME	
CNA1	25MAR11	REMOVED GEOMETRY.	B	76076P	U01A133	CIRCUIT DIAGRAM, TERRASTAR	
					RELEASE NO.	DATE	PART NO.
					67696A	15OCT10	AE08064595 023

Figure 66 Back-Up Camera

4.25. HEATED SEATS, P. 24

<p>NAVISTAR, INC <small>THIS PRINT IS PROVIDED ON A RESTRICTED BASIS AND IS NOT TO BE USED IN ANY WAY DETRIMENTAL TO THE INTEREST OF NAVISTAR, INC.</small></p>				<p>ELECTRICAL CIRCUIT DIAGRAM CHAPTER 4 HEATED SEATS</p>			
<p>INTENTIONALLY LEFT BLANK</p>							
CHR	DATE	CHANGE	REV	REFERENCE	DRAWN	NAME	
CNA1	25MAR11	REMOVED GEOMETRY.	B	76076P	U01A133	CIRCUIT DIAGRAM, TERRASTAR	
					RELEASE NO.	DATE	PART NO.
					67696A	15OCT10	AE08064595 024

Figure 67 Heated Seats

4.26. SWITCH PACK OPTIONAL GAUGE PACK, P. 25

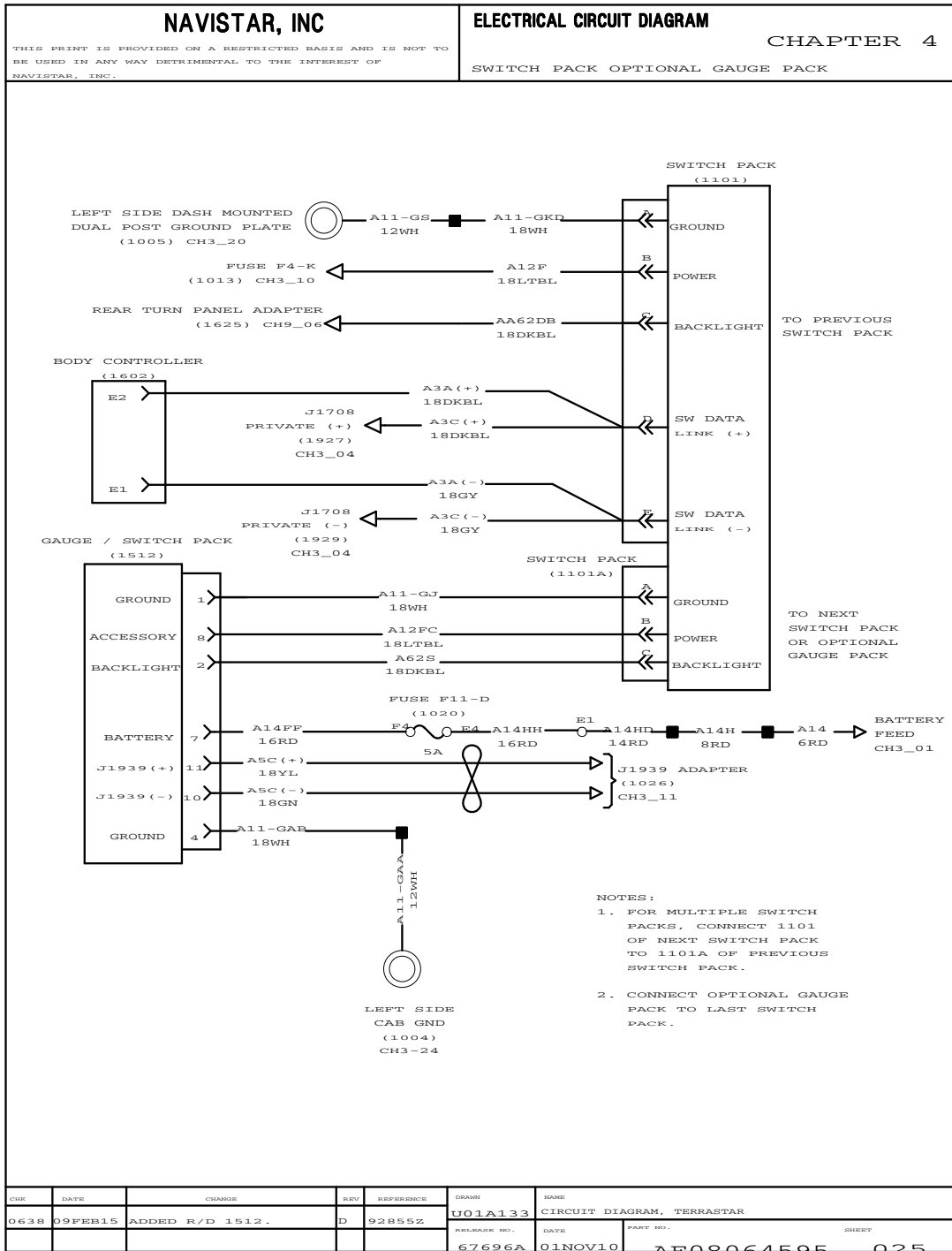

Figure 68 Switch Pack Optional Gauge Pack

4.27. WINDSHIELD WIPER, P. 26

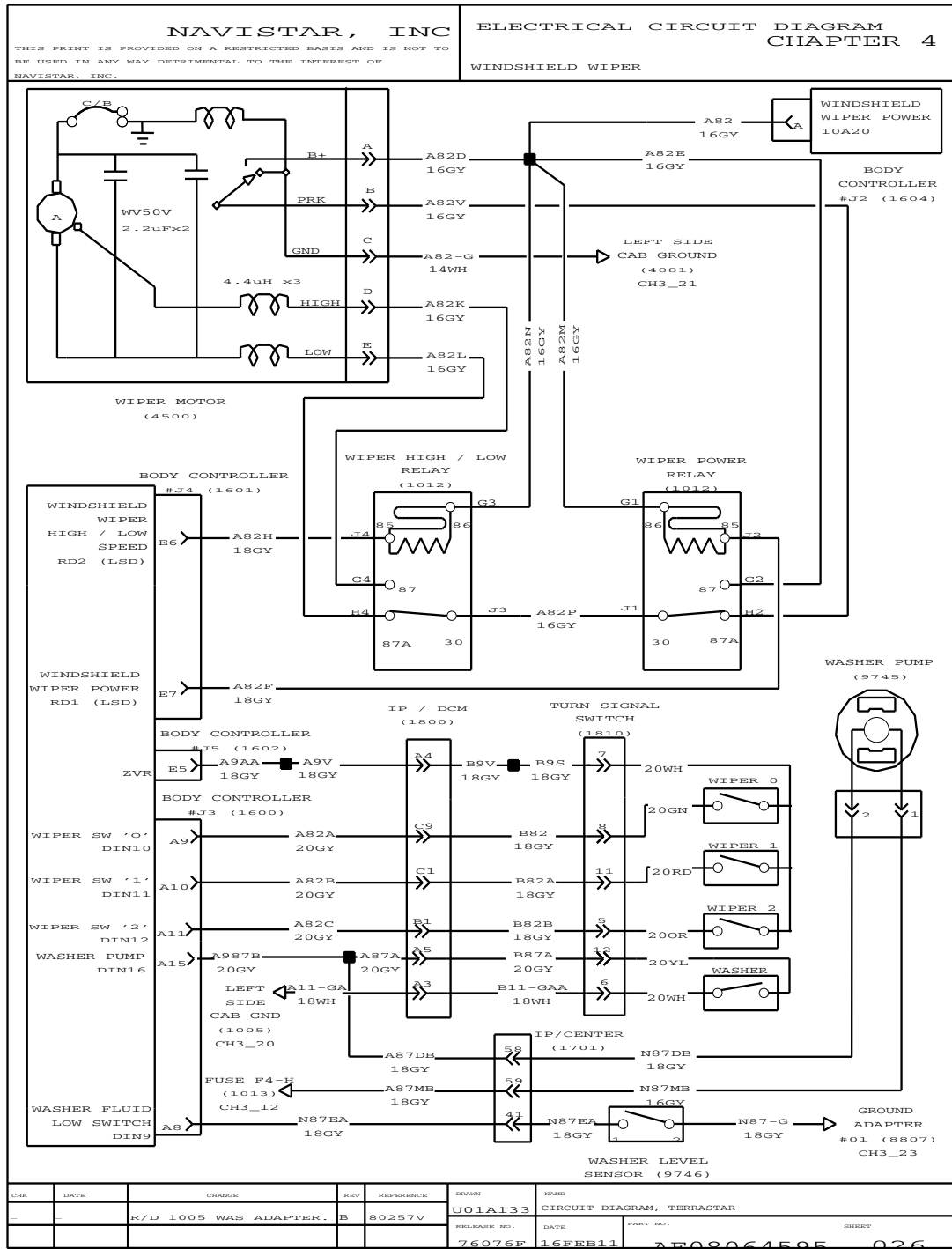

Figure 69 Windshield Wiper

4.28. SEAT BELT AND SEAT SENSOR, P. 27

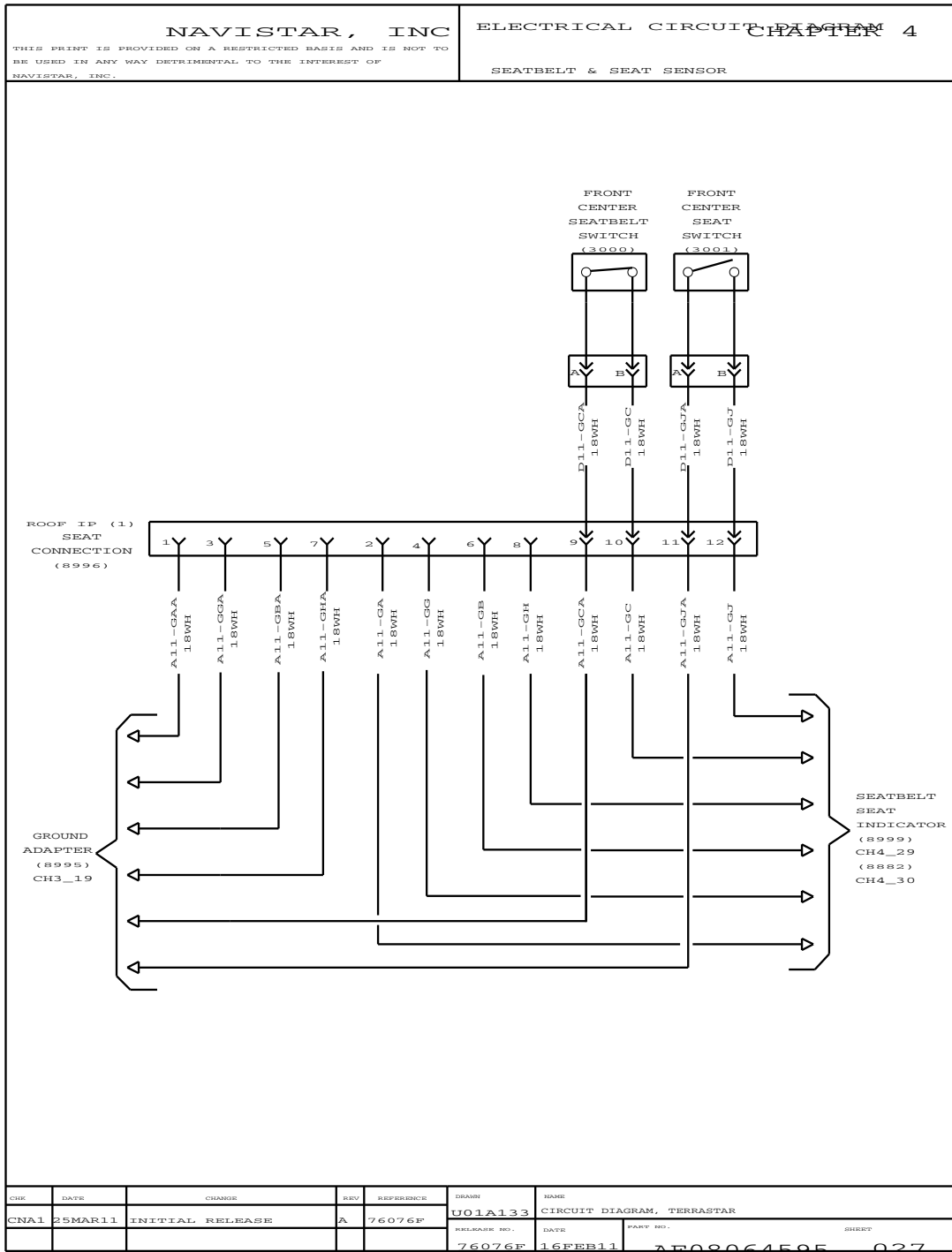

Figure 70 Seat Belt and Seat Sensor

4.29. SEAT BELT AND SEAT SENSOR (CONT.), P. 28

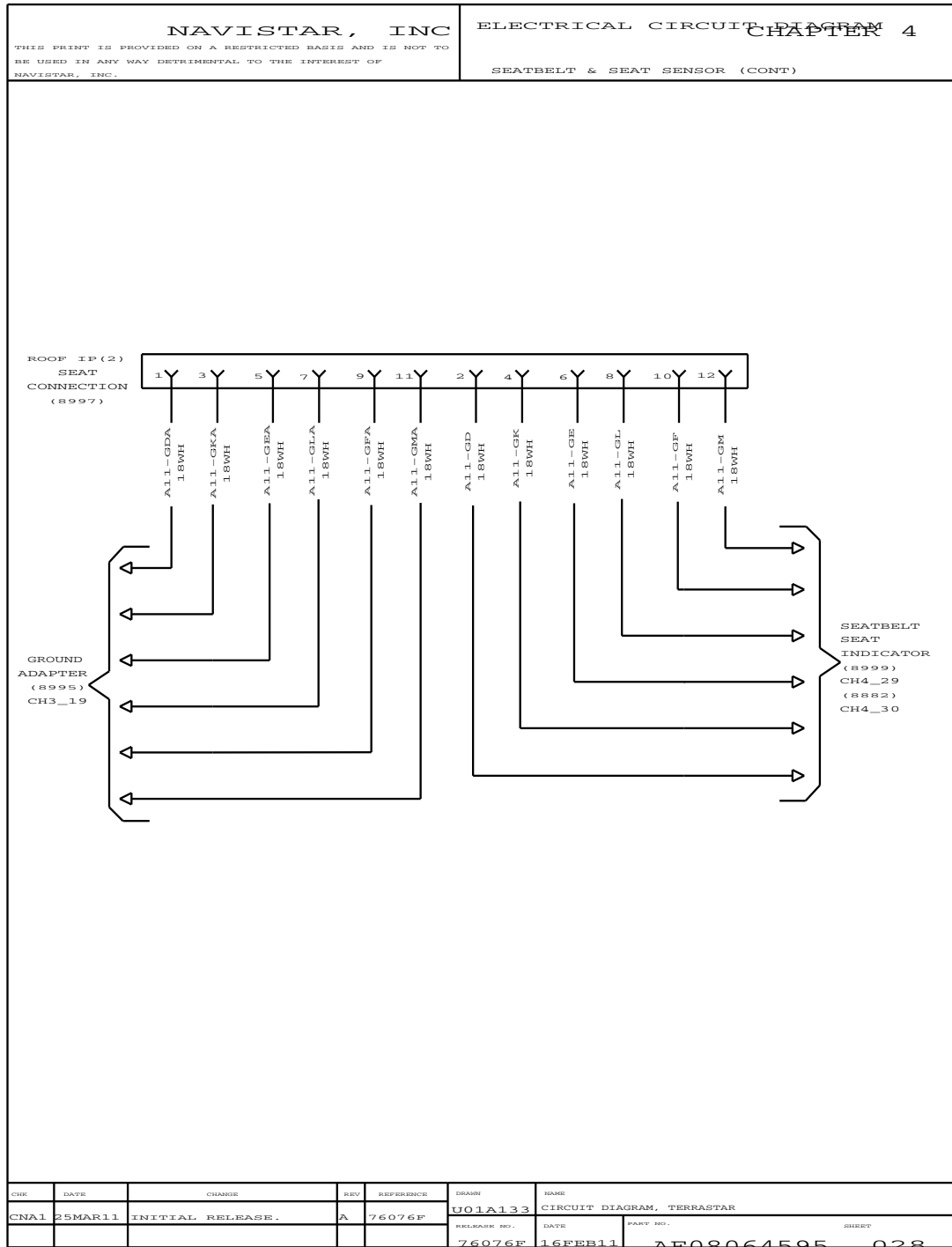

Figure 71 Seat Belt and Seat Sensor (Cont.)

4.30. SEAT BELT AND SEAT SENSOR (CONT.), P. 29

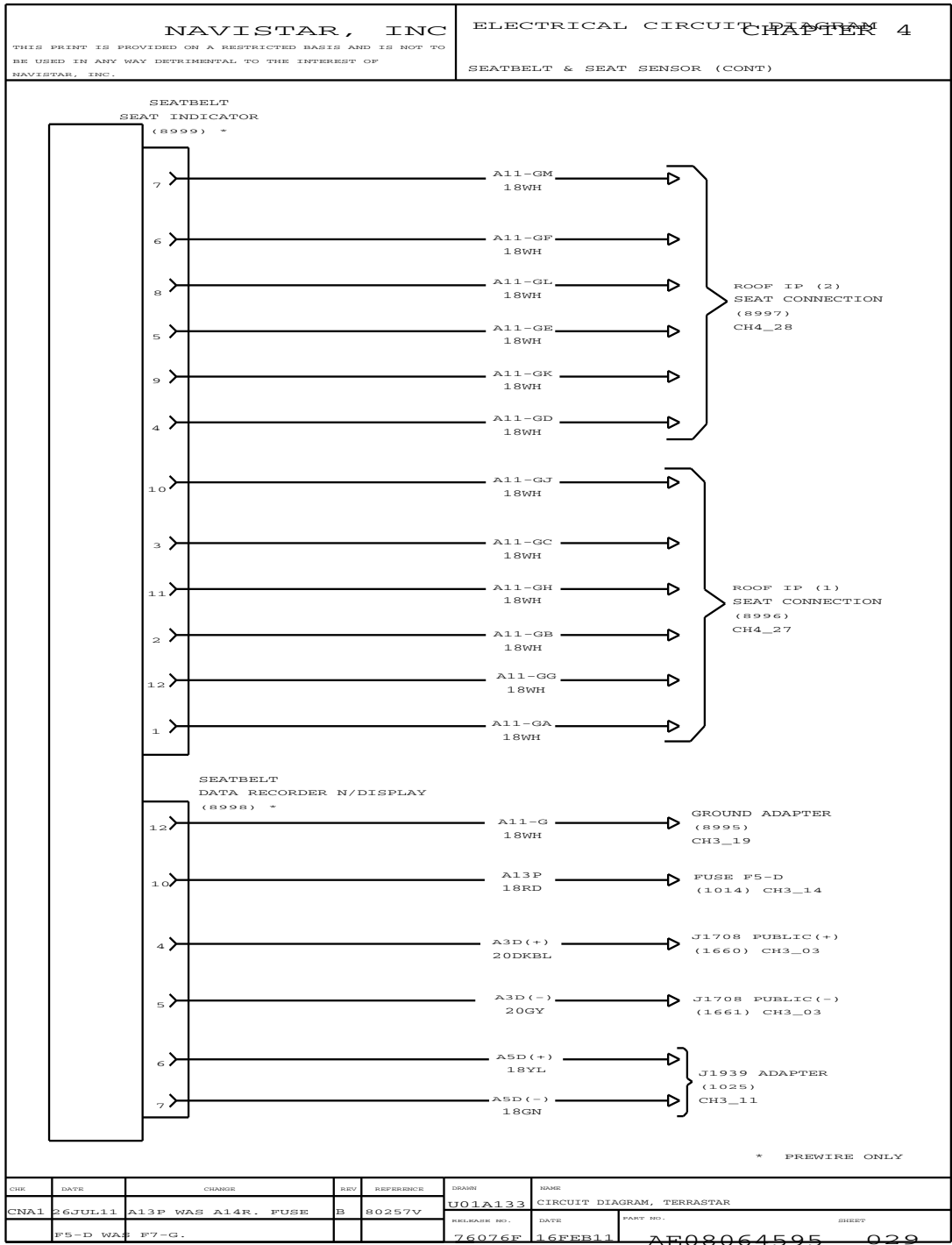

Figure 72 Seat Belt and Seat Sensor (Cont.)

4.31. SEAT BELT AND SEAT SENSOR (CONT.), P. 30

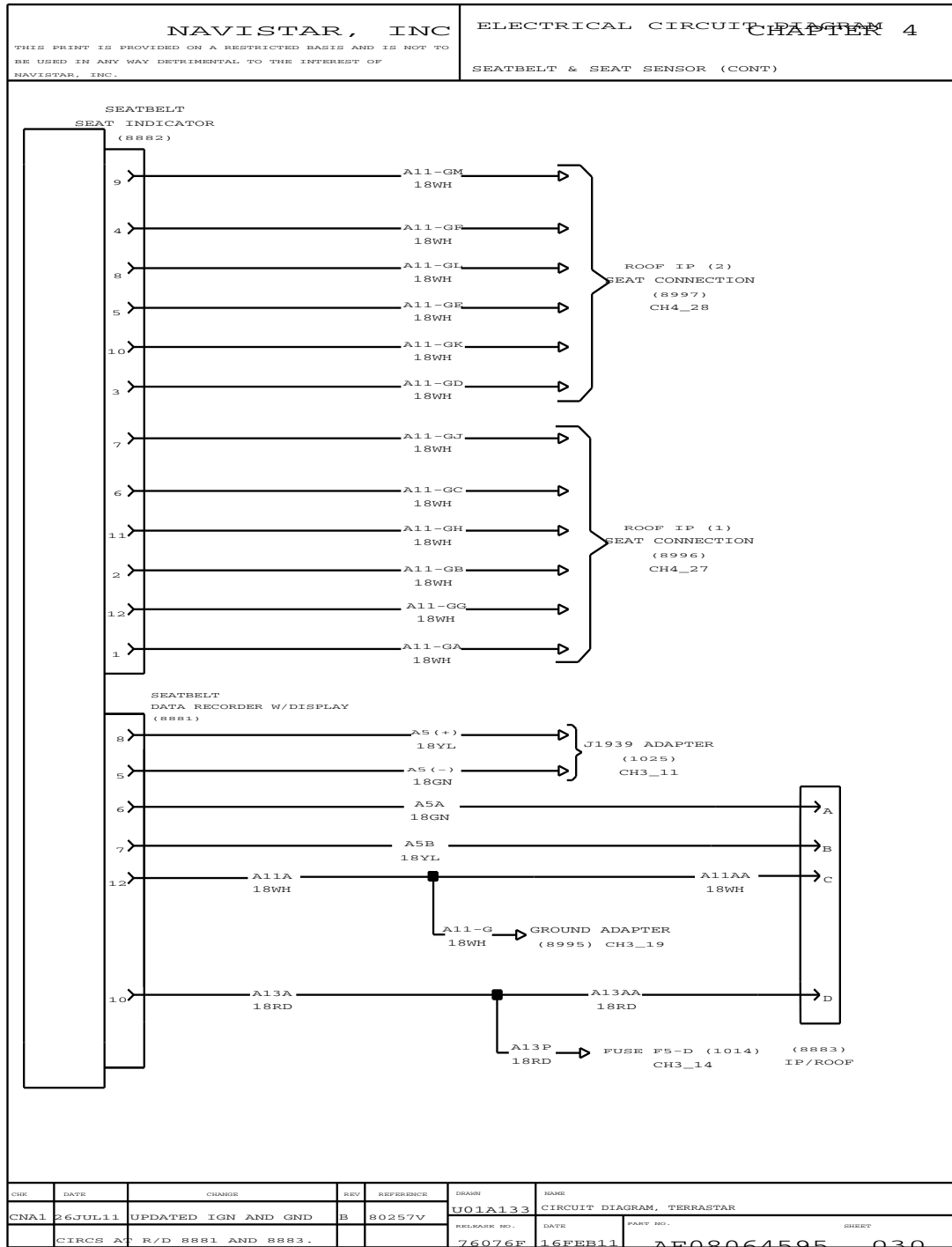

Figure 73 Seat Belt and Seat Sensor (Cont.)

12V CHARGING AND CRANKING SYSTEM (CHAPTER 5)

5.1. STARTING AND CRANKING ENGINE WITH ALLISON TRANSMISSION, P. 1

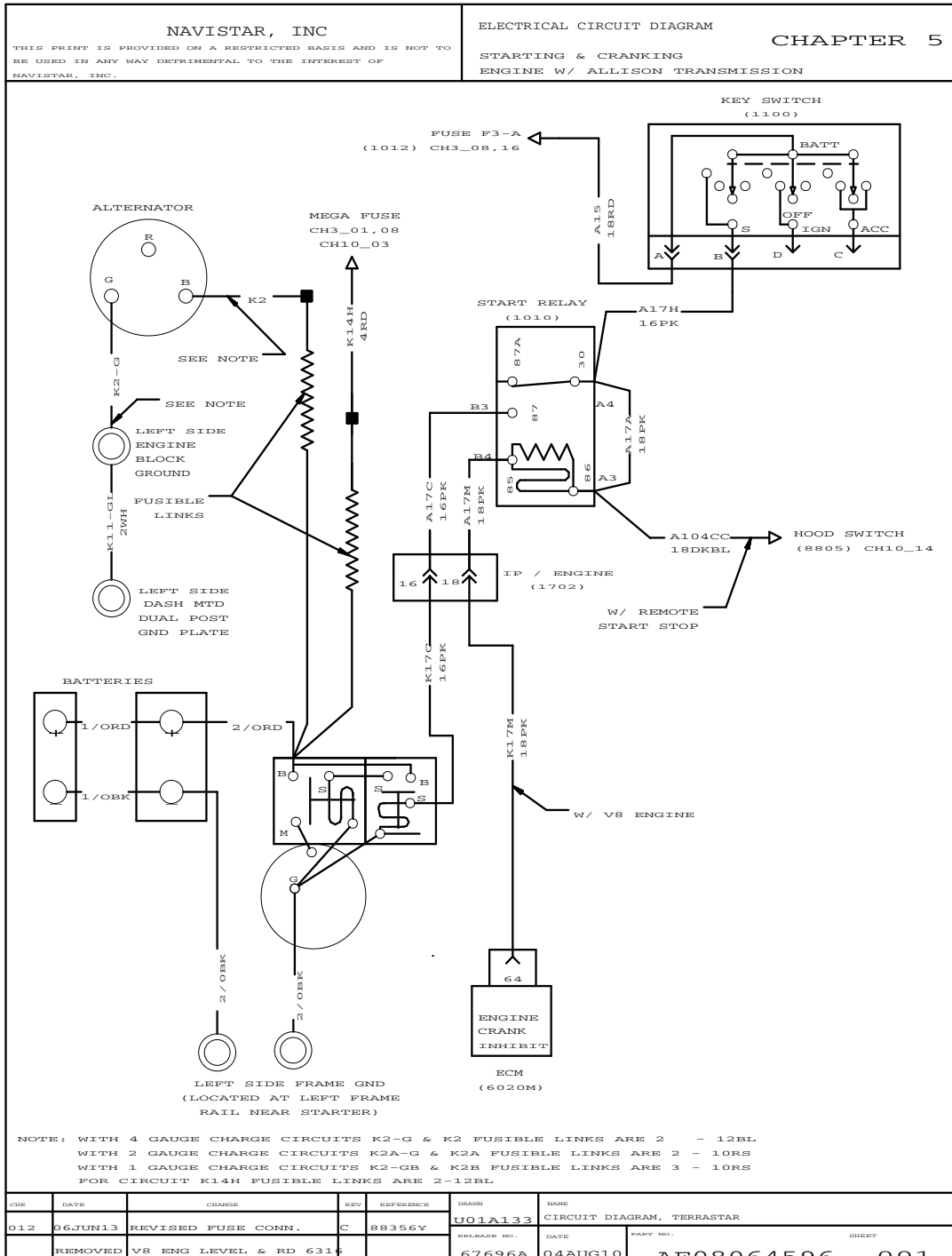

Figure 74 Starting and Cranking Engine with Allison Transmission

5.2. ROCKER START, P. 2

<p>NAVISTAR, INC</p> <p>THIS PRINT IS PROVIDED ON A RESTRICTED BASIS AND IS NOT TO BE USED IN ANY WAY DETRIMENTAL TO THE INTEREST OF NAVISTAR, INC.</p>				<p>ELECTRICAL CIRCUIT DIAGRAM</p> <p>CHAPTER 5</p> <p>ROCKER START</p>			
<p>INTENTIONALLY LEFT BLANK</p>							
CHR	DATE	CHANGE	REV	REFERENCE	DRAWN	NAME	
CNA1	25MAR11	REMOVED GEOMETRY.	B	76076P	U01A133	CIRCUIT DIAGRAM, TERRASTAR	
					RELEASE NO.	DATE	
					67696A	15OCT10	
						PART NO.	
						AE08064596	
						SHEET	
						002	

Figure 75 Rocker Start

FANS AND ENGINE ACCESSORIES (CHAPTER 6)

6.1. FAN WIRING – V8 ENGINE, P. 1

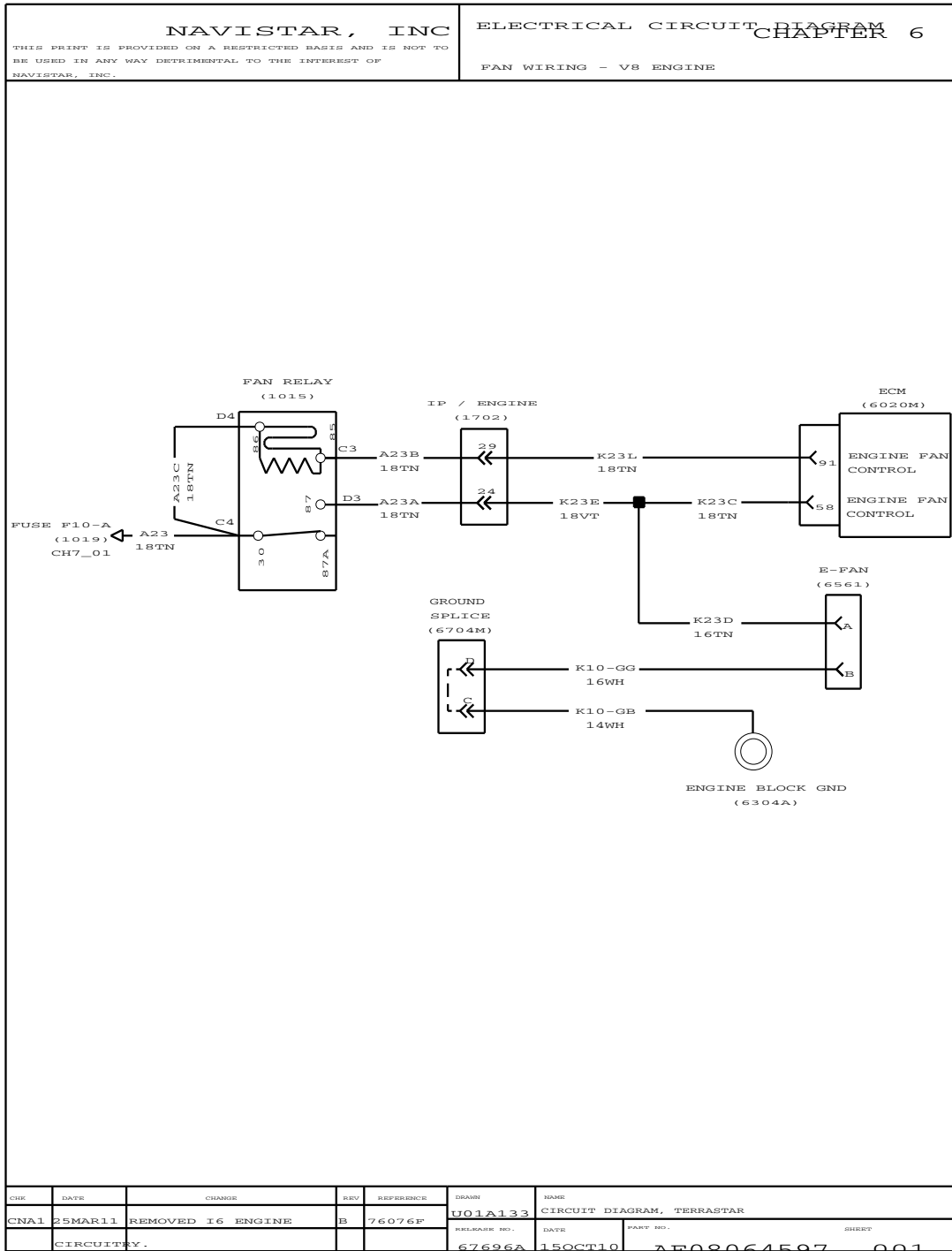

Figure 76 Fan Wiring – V8 Engine

6.2. SNOW VALVE, P. 2

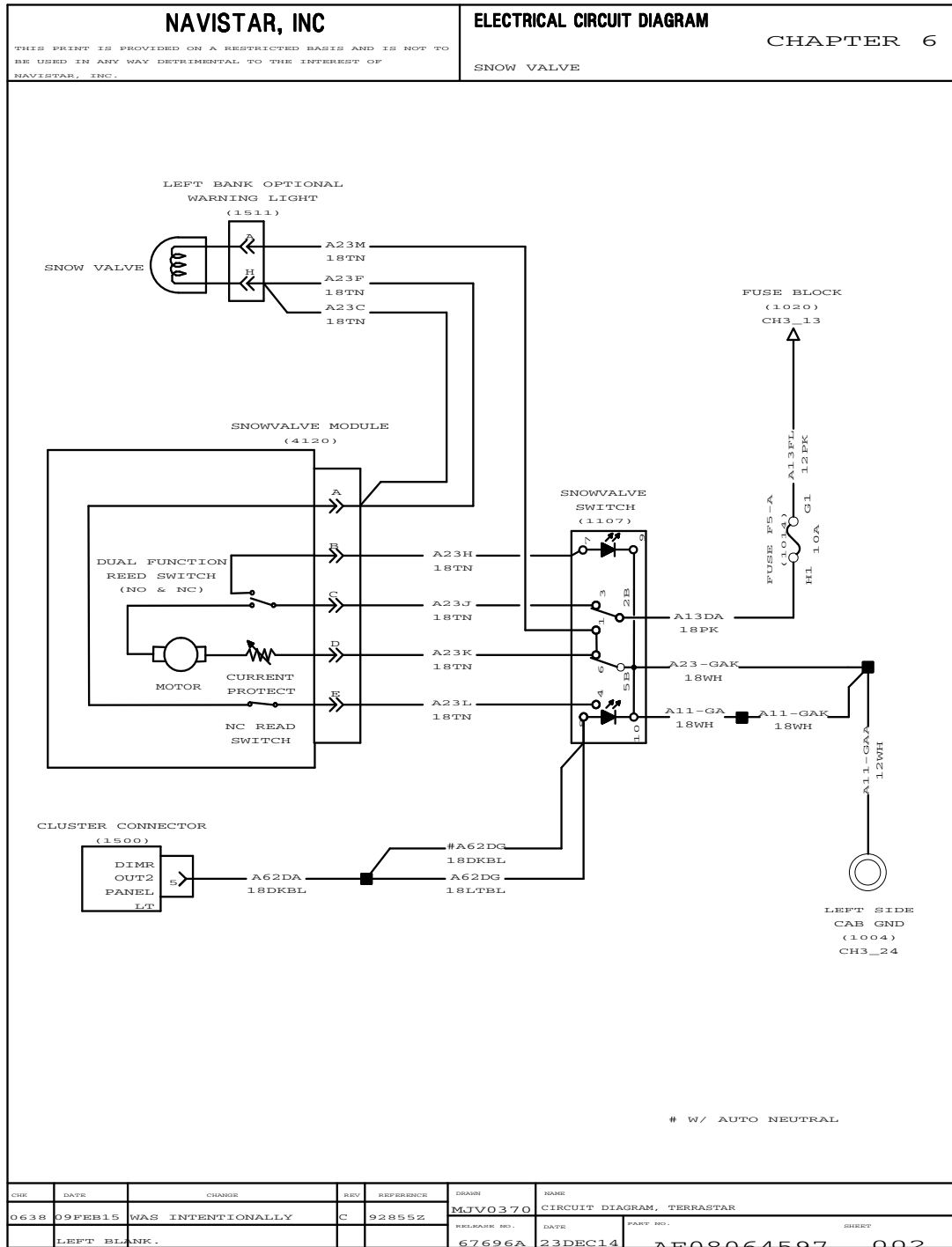

Figure 77 Snow Valve

ELECTRONIC ENGINES (CHAPTER 7)

7.1. ELECTRONIC ENGINE CONTROLS – V8 ENGINE, P. 1

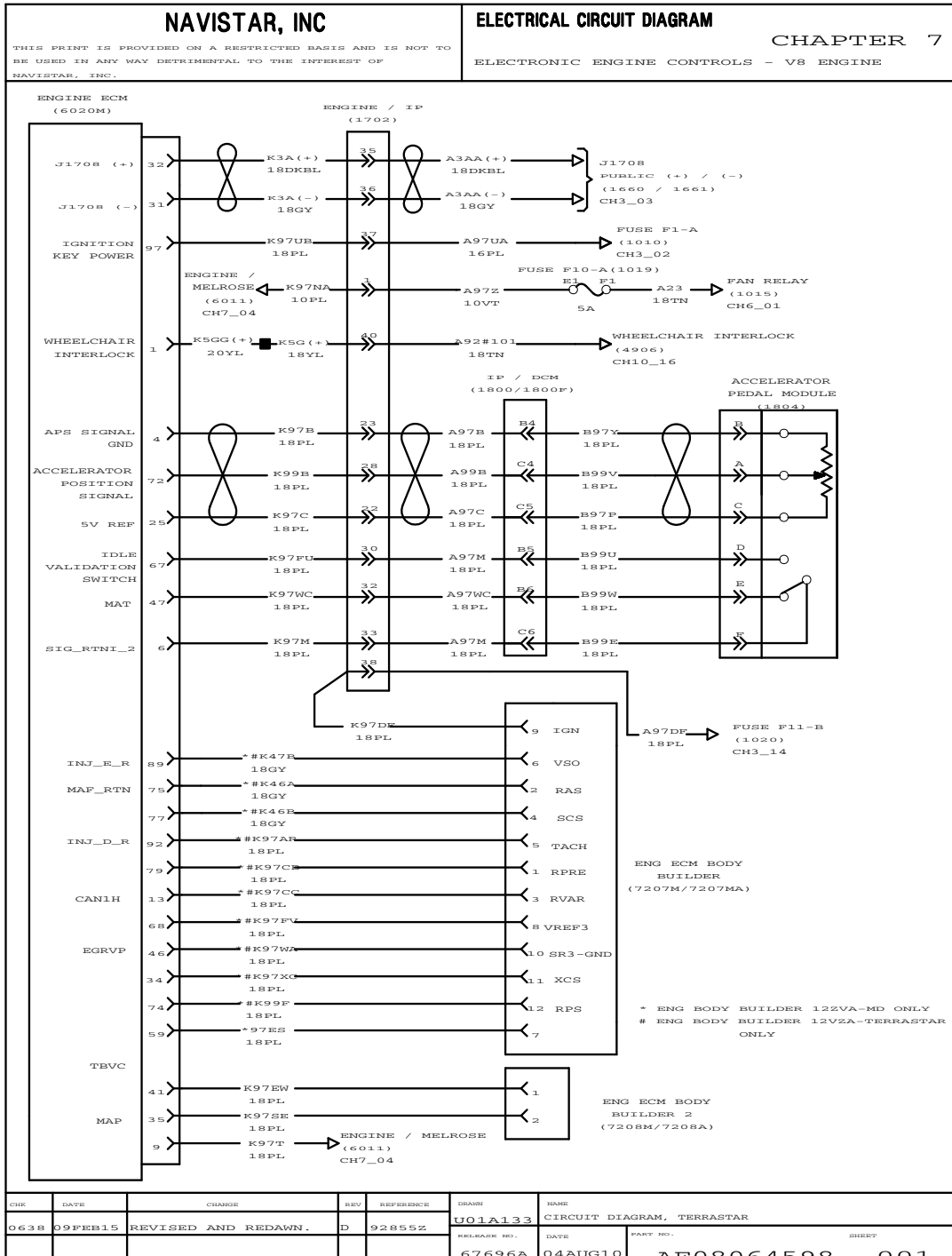

Figure 78 Electronic Engine Controls – V8 Engine

7.2. ELECTRONIC ENGINE CONTROLS – V8 ENGINE (CONT.), P. 2

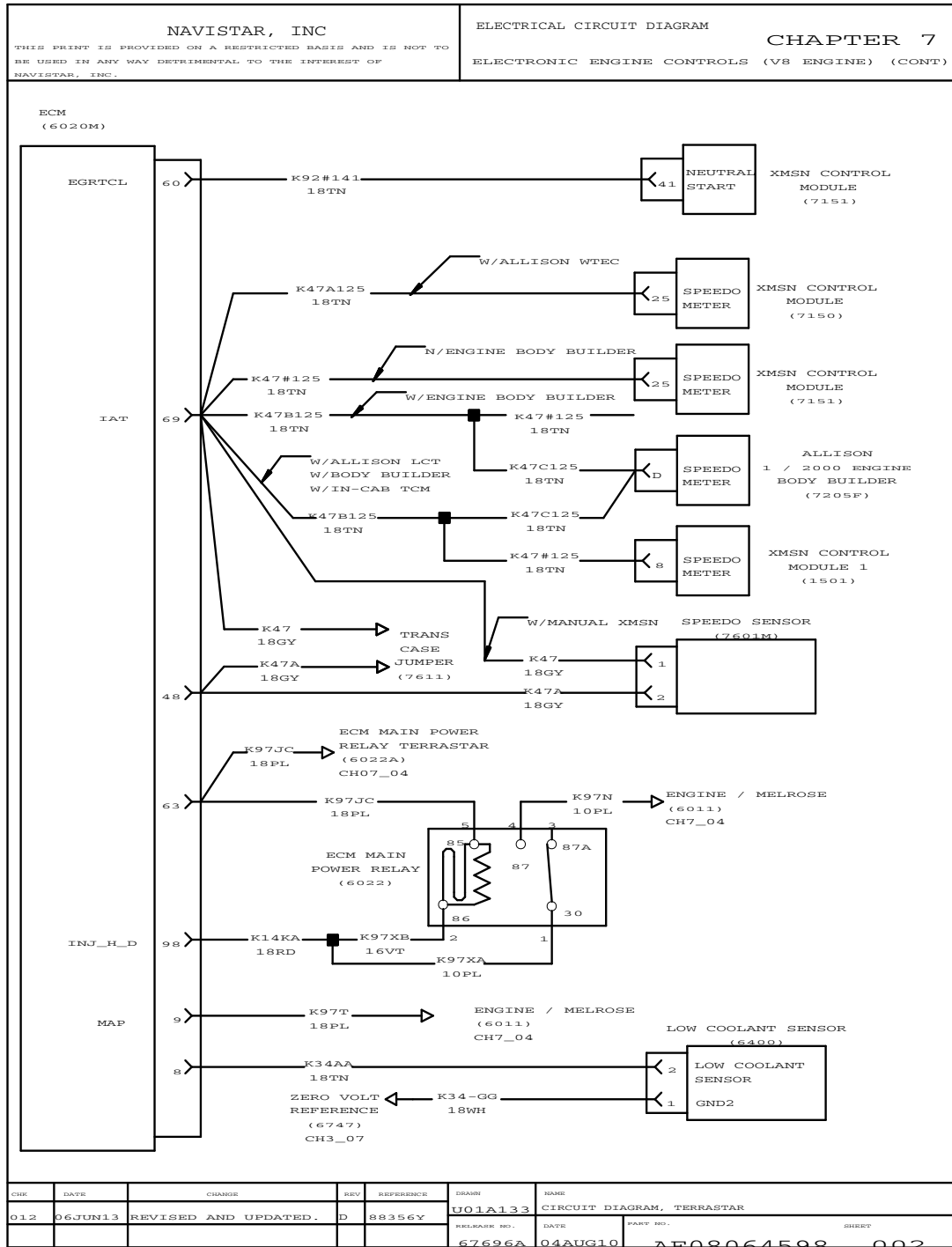

Figure 79 Electronic Engine Controls – V8 Engine (Cont.)

7.3. ELECTRONIC ENGINE CONTROLS – V8 ENGINE (CONT.), P. 3

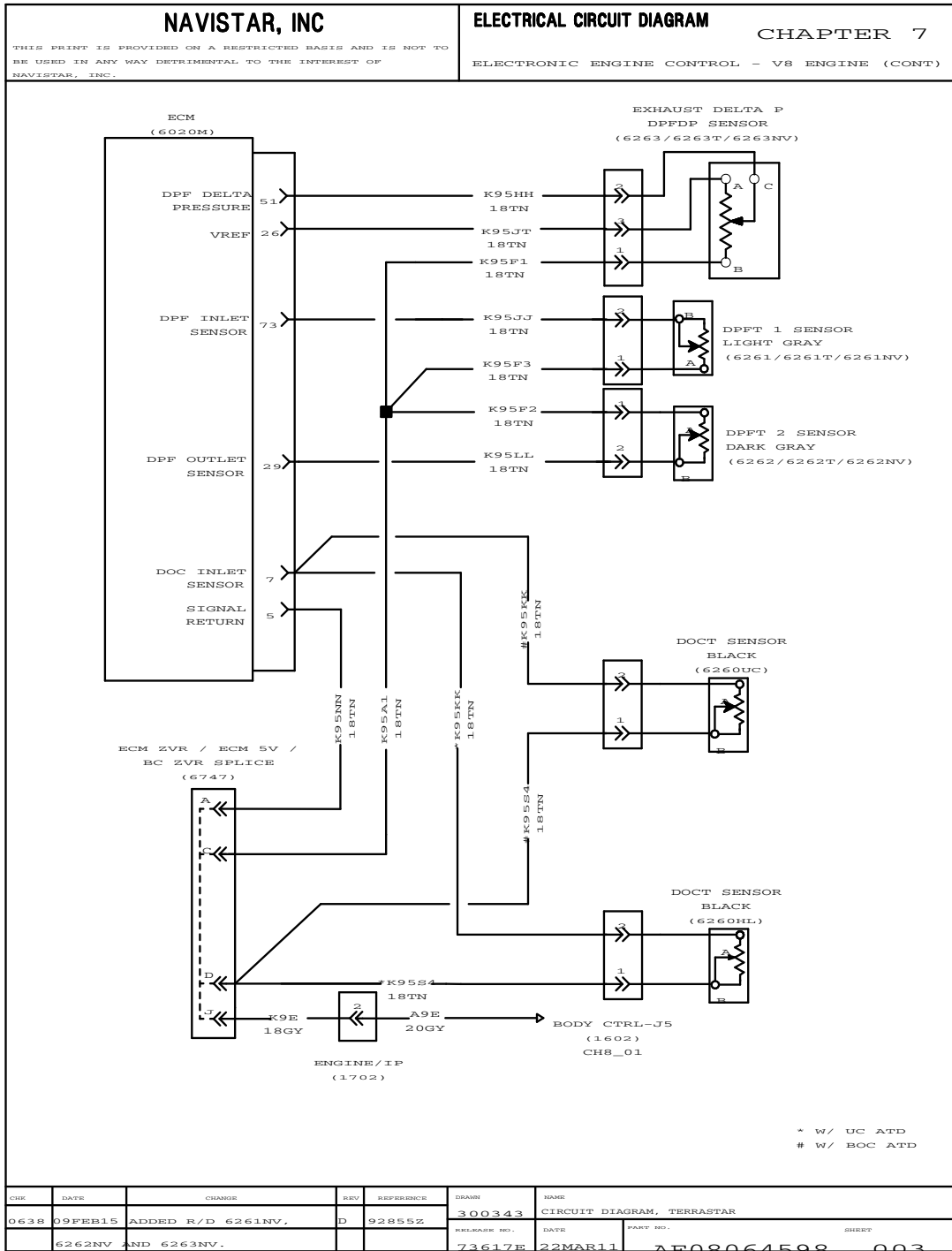

Figure 80 Electronic Engine Controls – V8 Engine (Cont.)

7.4. ELECTRONIC ENGINE CONTROLS – V8 ENGINE (CONT.), P. 3

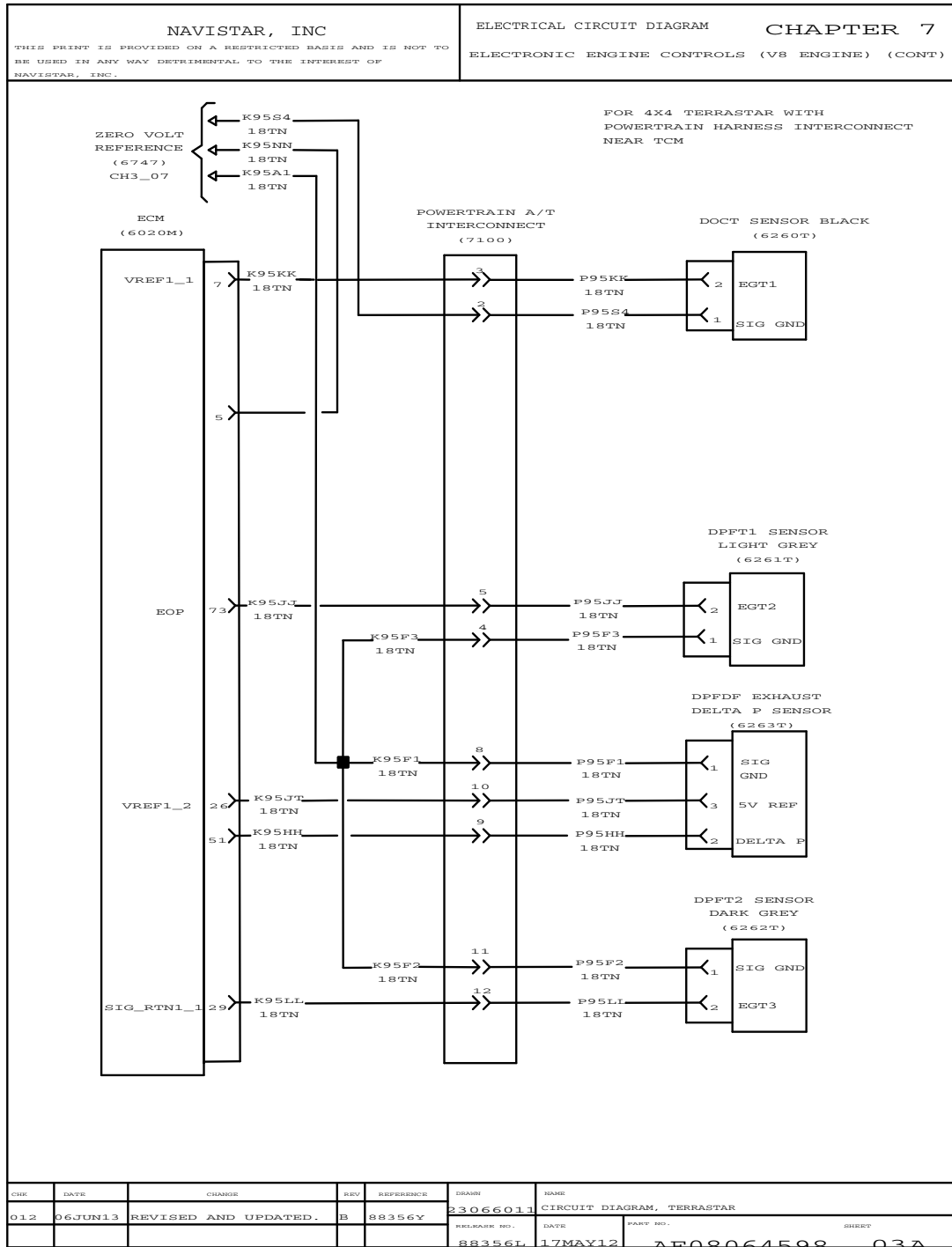

Figure 81 Electronic Engine Controls – V8 Engine (Cont.)

7.5. ELECTRONIC ENGINE CONTROLS – V8 ENGINE (CONT.), P. 4

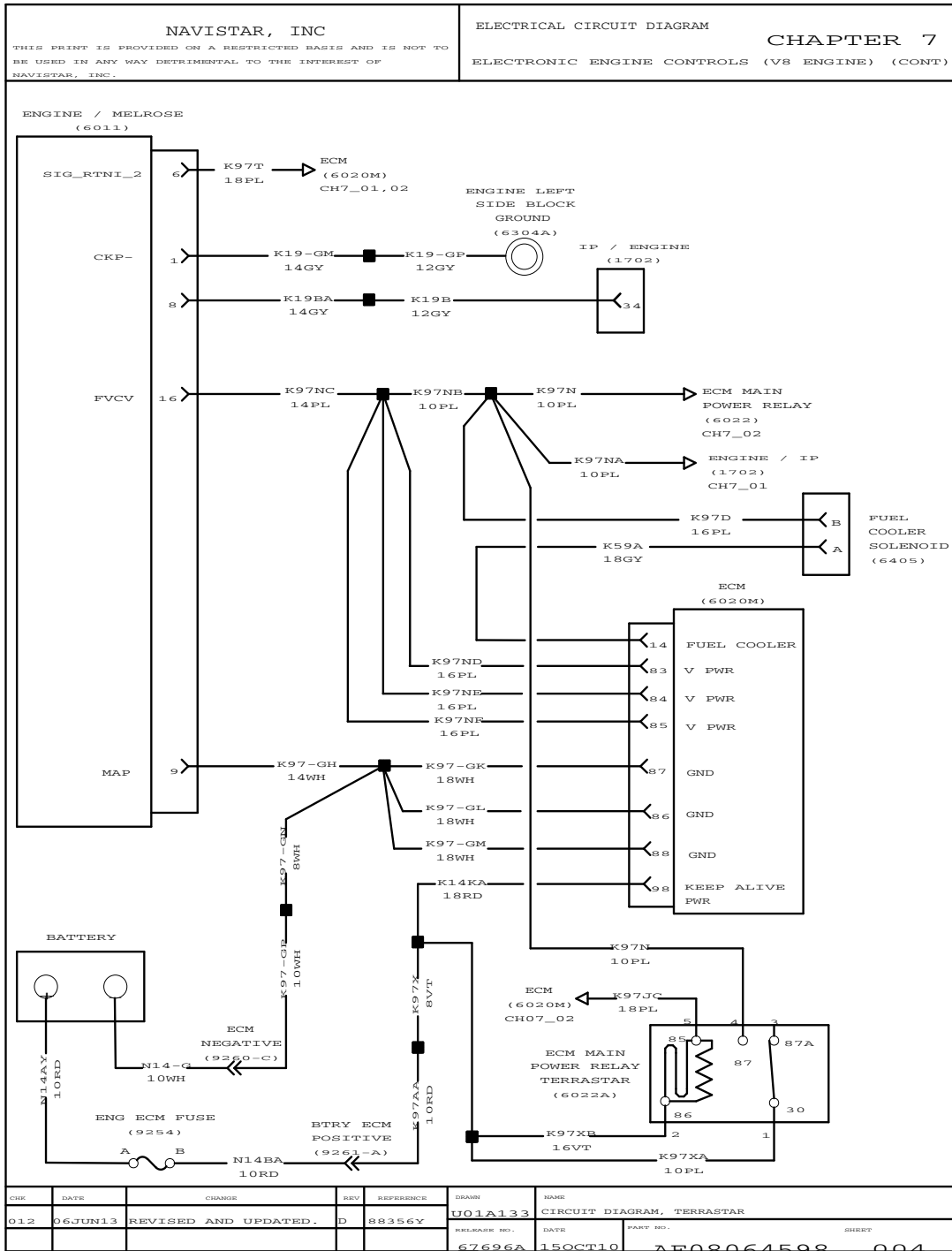

Figure 82 Electronic Engine Controls – V8 Engine (Cont.)

7.6. ELECTRONIC ENGINE CONTROLS – V8 ENGINE CRUISE CONTROLS, P. 5

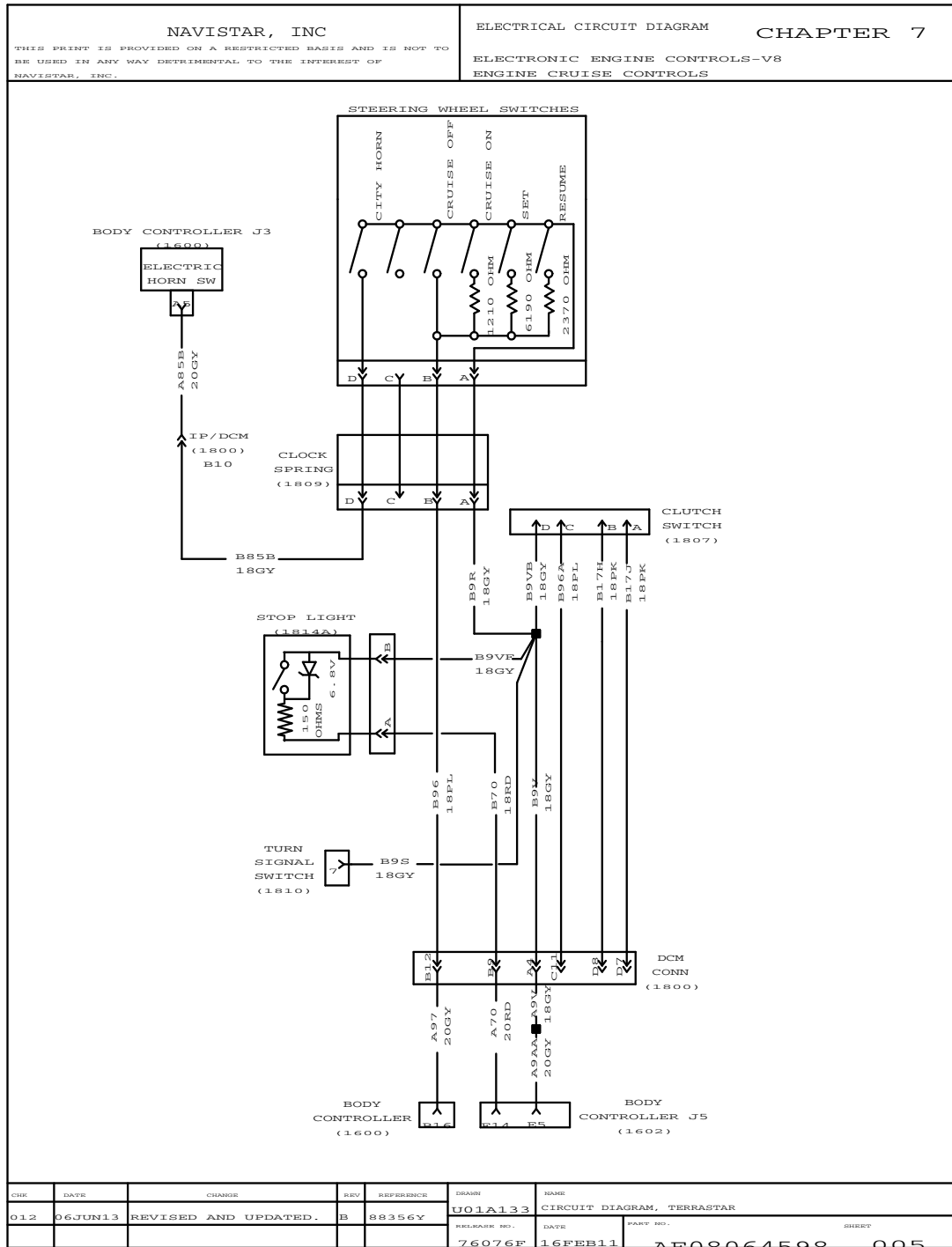

Figure 83 Electronic Engine Controls – V8 Engine Cruise Controls

GAUGES WITH AND WITHOUT INTERNAL WARNING LIGHT (CHAPTER 8)

8.1. BRAKE SWITCH AND PARK BRAKE SWITCH, P. 1

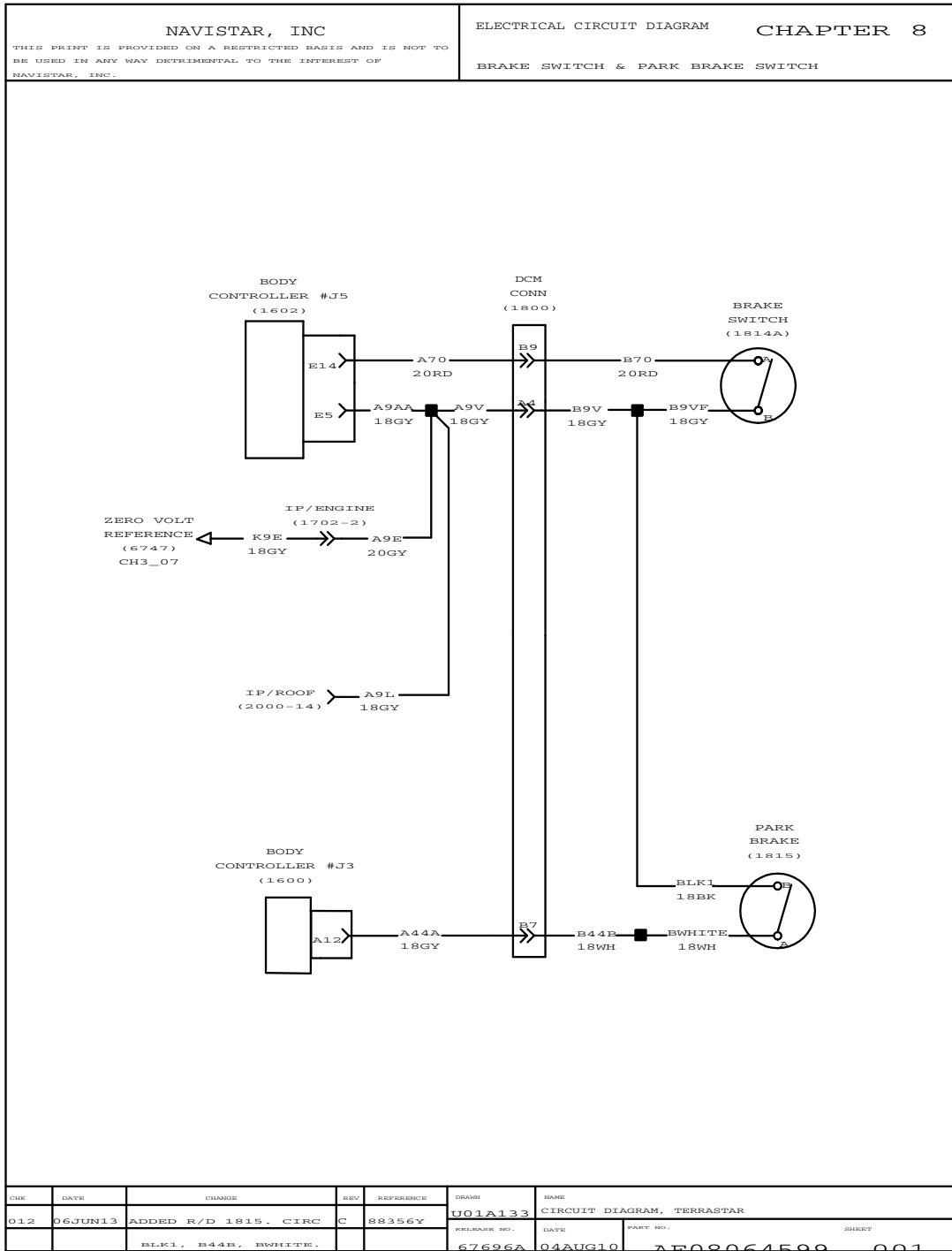

Figure 84 Brake Switch and Park Brake Switch

8.2. GAUGES AND WARNING LIGHTS – AMMETER, P. 2

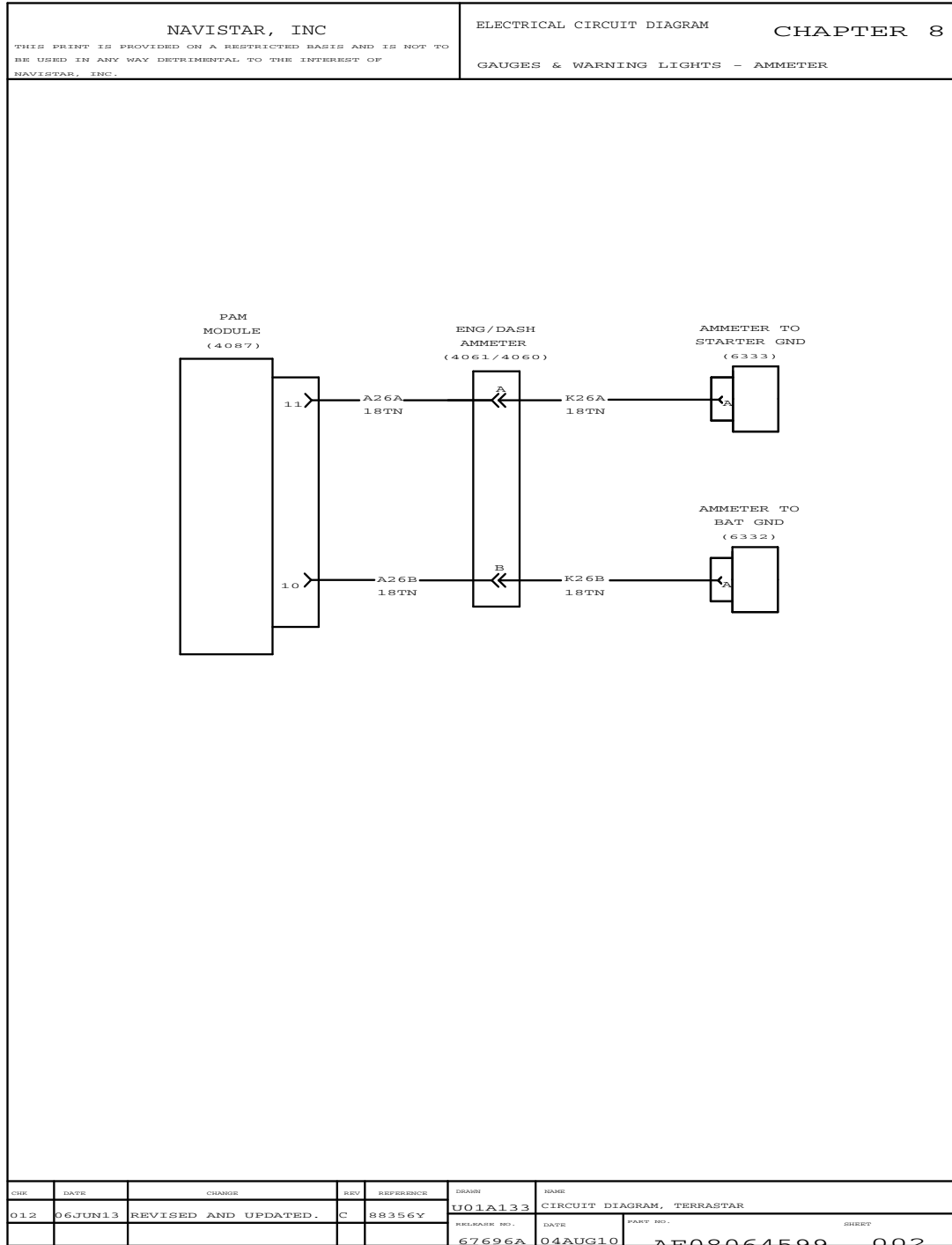

Figure 85 Gauges and Warning Lights – Ammeter

8.3. INTENTIONALLY LEFT BLANK, P. 3

NAVISTAR, INC <small>THIS PRINT IS PROVIDED ON A RESTRICTED BASIS AND IS NOT TO BE USED IN ANY WAY DETRIMENTAL TO THE INTEREST OF NAVISTAR, INC.</small>				ELECTRICAL CIRCUIT DIAGRAM CHAPTER 8 AIR PARK BRAKE							
INTENTIONALLY LEFT BLANK											
CHR	DATE	CHANGE	REV	REFERENCE	DRAWN	NAME					
CNA1	25MAR11	REMOVED GEOMETRY.	B	76076P	U01A133	CIRCUIT DIAGRAM, TERRASTAR					
					RELEASE NO.	DATE	PART NO.	SHEET			
					67696A	04AUG10	AE08064599	003			

Figure 86 Intentionally Left Blank

8.4. AIR PRESSURE INPUT CIRCUIT, P. 4

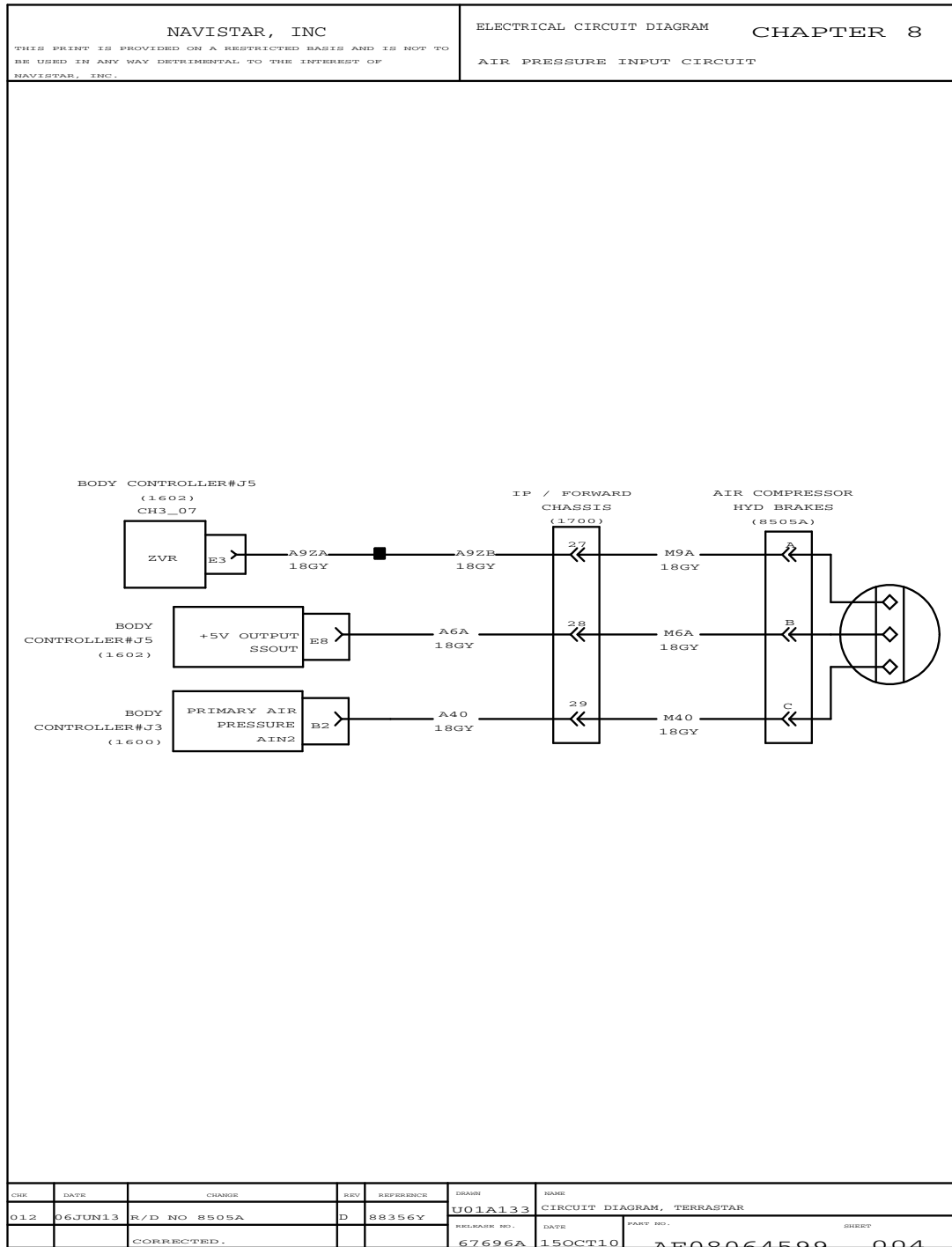

Figure 87 Air Pressure Input Circuit

8.5. IP GAUGES AND WARNING LIGHTS – GAUGE CLUSTER, P. 5

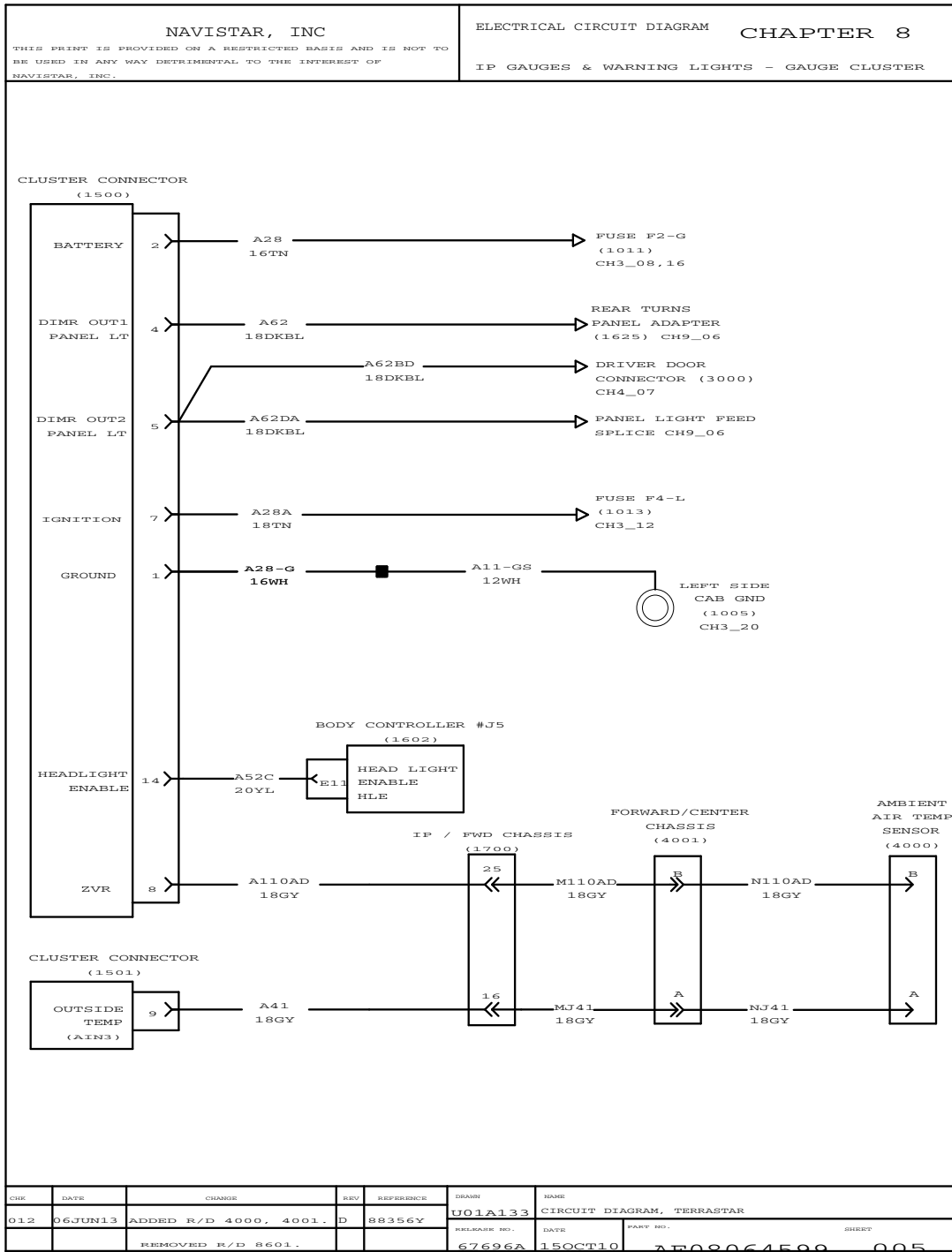

Figure 88 IP Gauges and Warning Lights – Gauge Cluster

8.6. IP / GAUGES, P. 6

<p>NAVISTAR, INC</p> <p>THIS PRINT IS PROVIDED ON A RESTRICTED BASIS AND IS NOT TO BE USED IN ANY WAY DETRIMENTAL TO THE INTEREST OF NAVISTAR, INC.</p>				<p>ELECTRICAL CIRCUIT DIAGRAM CHAPTER 8</p> <p>IP / GAUGES</p>																																																						
<p>INSTRUMENT PANEL GAUGES</p>																																																										
<table border="1" style="width: 100%; border-collapse: collapse;"> <thead> <tr> <th style="width: 20%;">GAUGE</th> <th style="width: 10%;">WARN LIGHT</th> <th style="width: 40%;">SIGNAL PATH</th> <th style="width: 30%;">SENSOR LOCATION</th> </tr> </thead> <tbody> <tr> <td>RPM (TACH)</td> <td>NO</td> <td>ENGINE CTRLR / DRIVE TRAIN J1939 / CLUSTER</td> <td>ENGINE</td> </tr> <tr> <td>MPH/KPH (SPD)</td> <td>NO</td> <td>ENGINE CTRLR / DRIVE TRAIN J1939 / CLUSTER</td> <td>TRANSMISSION</td> </tr> <tr> <td>FUEL</td> <td>YES</td> <td>SYSTEM CTRLR / DRIVE TRAIN J1939 / CLUSTER</td> <td>FUEL TANK</td> </tr> <tr> <td>VOLT</td> <td>YES</td> <td>SYSTEM CTRLR / DRIVE TRAIN J1939 / CLUSTER</td> <td>-</td> </tr> <tr> <td>AIR 1 (PRES)</td> <td>YES</td> <td>SYSTEM CTRLR / DRIVE TRAIN J1939 / CLUSTER</td> <td>INSIDE CAB-DASH ENL</td> </tr> <tr> <td>AIR 2 (PRES)</td> <td>YES</td> <td>SYSTEM CTRLR / DRIVE TRAIN J1939 / CLUSTER</td> <td>STEERING COL AREA</td> </tr> <tr> <td>WATER (TEMP)</td> <td>YES</td> <td>ENGINE CTRLR / DRIVE TRAIN J1939 / CLUSTER</td> <td>ENGINE</td> </tr> <tr> <td>ENG OIL (TEMP)</td> <td>YES</td> <td>ENGINE CTRLR / DRIVE TRAIN J1939 / CLUSTER</td> <td>ENGINE</td> </tr> <tr> <td>OIL (PRES)</td> <td>YES</td> <td>ENGINE CTRLR / DRIVE TRAIN J1939 / CLUSTER</td> <td>ENGINE</td> </tr> <tr> <td>TRANS (TEMP)</td> <td>YES</td> <td>SYSTEM CTRLR / DRIVE TRAIN J1939 / CLUSTER</td> <td>TRANSMISSION</td> </tr> <tr> <td>AIR APPLICATION</td> <td>NO</td> <td>SYSTEM CTRLR / DRIVE TRAIN J1939 / CLUSTER</td> <td>FWD CHASSIS</td> </tr> <tr> <td>REAR AXLE TEMP</td> <td>YES</td> <td>SYSTEM CTRLR / DRIVE TRAIN J1939 / CLUSTER</td> <td>AXLE</td> </tr> </tbody> </table>							GAUGE	WARN LIGHT	SIGNAL PATH	SENSOR LOCATION	RPM (TACH)	NO	ENGINE CTRLR / DRIVE TRAIN J1939 / CLUSTER	ENGINE	MPH/KPH (SPD)	NO	ENGINE CTRLR / DRIVE TRAIN J1939 / CLUSTER	TRANSMISSION	FUEL	YES	SYSTEM CTRLR / DRIVE TRAIN J1939 / CLUSTER	FUEL TANK	VOLT	YES	SYSTEM CTRLR / DRIVE TRAIN J1939 / CLUSTER	-	AIR 1 (PRES)	YES	SYSTEM CTRLR / DRIVE TRAIN J1939 / CLUSTER	INSIDE CAB-DASH ENL	AIR 2 (PRES)	YES	SYSTEM CTRLR / DRIVE TRAIN J1939 / CLUSTER	STEERING COL AREA	WATER (TEMP)	YES	ENGINE CTRLR / DRIVE TRAIN J1939 / CLUSTER	ENGINE	ENG OIL (TEMP)	YES	ENGINE CTRLR / DRIVE TRAIN J1939 / CLUSTER	ENGINE	OIL (PRES)	YES	ENGINE CTRLR / DRIVE TRAIN J1939 / CLUSTER	ENGINE	TRANS (TEMP)	YES	SYSTEM CTRLR / DRIVE TRAIN J1939 / CLUSTER	TRANSMISSION	AIR APPLICATION	NO	SYSTEM CTRLR / DRIVE TRAIN J1939 / CLUSTER	FWD CHASSIS	REAR AXLE TEMP	YES	SYSTEM CTRLR / DRIVE TRAIN J1939 / CLUSTER	AXLE
GAUGE	WARN LIGHT	SIGNAL PATH	SENSOR LOCATION																																																							
RPM (TACH)	NO	ENGINE CTRLR / DRIVE TRAIN J1939 / CLUSTER	ENGINE																																																							
MPH/KPH (SPD)	NO	ENGINE CTRLR / DRIVE TRAIN J1939 / CLUSTER	TRANSMISSION																																																							
FUEL	YES	SYSTEM CTRLR / DRIVE TRAIN J1939 / CLUSTER	FUEL TANK																																																							
VOLT	YES	SYSTEM CTRLR / DRIVE TRAIN J1939 / CLUSTER	-																																																							
AIR 1 (PRES)	YES	SYSTEM CTRLR / DRIVE TRAIN J1939 / CLUSTER	INSIDE CAB-DASH ENL																																																							
AIR 2 (PRES)	YES	SYSTEM CTRLR / DRIVE TRAIN J1939 / CLUSTER	STEERING COL AREA																																																							
WATER (TEMP)	YES	ENGINE CTRLR / DRIVE TRAIN J1939 / CLUSTER	ENGINE																																																							
ENG OIL (TEMP)	YES	ENGINE CTRLR / DRIVE TRAIN J1939 / CLUSTER	ENGINE																																																							
OIL (PRES)	YES	ENGINE CTRLR / DRIVE TRAIN J1939 / CLUSTER	ENGINE																																																							
TRANS (TEMP)	YES	SYSTEM CTRLR / DRIVE TRAIN J1939 / CLUSTER	TRANSMISSION																																																							
AIR APPLICATION	NO	SYSTEM CTRLR / DRIVE TRAIN J1939 / CLUSTER	FWD CHASSIS																																																							
REAR AXLE TEMP	YES	SYSTEM CTRLR / DRIVE TRAIN J1939 / CLUSTER	AXLE																																																							
<p>NOTES:</p> <p>1. WARNING LIGHTS ARE PART OF THE GAUGES AND ARE LOCATED IN THE GAUGE</p>																																																										
CHK	DATE	CHANGE	REV	REFERENCE	DRAWN	NAME																																																				
CNA1	26JUL11	INITIAL RELEASE.	A	80257V	U00KDD2	CIRCUIT DIAGRAM, TERRASTAR																																																				
					RELEASE NO.	DATE																																																				
					80257V	24JUN11																																																				
						PART NO.																																																				
						AE08064599																																																				
						SHEET																																																				
						006																																																				

Figure 89 IP / Gauges

8.7. WARNING LIGHTS LIST, P. 7

NAVISTAR, INC <small>THIS PRINT IS PROVIDED ON A RESTRICTED BASIS AND IS NOT TO BE USED IN ANY WAY DETRIMENTAL TO THE INTEREST OF NAVISTAR, INC.</small>				ELECTRICAL CIRCUIT DIAGRAM CHAPTER 8 WARNING LIGHTS LIST																																																																																																																																																																																																																																																																																										
<table border="1" style="width: 100%; border-collapse: collapse;"> <thead> <tr> <th colspan="7" style="text-align: center;">IF WARNING LIGHTS</th> </tr> <tr> <th style="width: 30%;">WARNING LIGHT TITLE</th> <th colspan="4" style="text-align: center;">SIGNAL PATH</th> <th colspan="2" style="text-align: center;">SENSOR LOCATION</th> </tr> </thead> <tbody> <tr><td>RANGE INHIBITED</td><td colspan="4">TRANS CTRLR / DRIVE TRAIN J1939 / CLUSTER</td><td colspan="2"></td></tr> <tr><td>FUEL FILTER</td><td colspan="4">SYSTEM CTRLR / DRIVE TRAIN J1939 / CLUSTER</td><td colspan="2">FUEL FILTER</td></tr> <tr><td>ENGINE (YELLOW LED)</td><td colspan="4">ENGINE CTRLR / DRIVE TRAIN J1939 / CLUSTER</td><td colspan="2"></td></tr> <tr><td>ENGINE (RED LED)</td><td colspan="4">ENGINE CTRLR / DRIVE TRAIN J1939 / CLUSTER</td><td colspan="2"></td></tr> <tr><td>BRAKE PRESSURE (O)</td><td colspan="4">SYSTEM CTRLR / DRIVE TRAIN J1939 / CLUSTER</td><td colspan="2">SWITCH</td></tr> <tr><td>BRAKE FLUID</td><td colspan="4">SYSTEM CTRLR / DRIVE TRAIN J1939 / CLUSTER</td><td colspan="2">BRK RESERVOIR</td></tr> <tr><td>TRAC CTRL</td><td colspan="4">TRUCK ABS CTRLR / DRIVE TRAIN J1939 / CLUSTER</td><td colspan="2"></td></tr> <tr><td>CHECK TRANS</td><td colspan="4">TRANS CTRLR / DRIVE TRAIN J1939 / CLUSTER</td><td colspan="2"></td></tr> <tr><td>TRAILER ABS</td><td colspan="4">TRLR ABS CTRLR / DRIVE TRAIN J1939 / CLUSTER</td><td colspan="2"></td></tr> <tr><td>WASHER FLUID</td><td colspan="4">SYSTEM CTRLR / DRIVE TRAIN J1939 / CLUSTER</td><td colspan="2">WASHER BOTTLE</td></tr> <tr><td>(LEFT TURN)</td><td colspan="4">SYSTEM CTRLR / DRIVE TRAIN J1939 / CLUSTER</td><td colspan="2">TURN SIG SW</td></tr> <tr><td>AIR BAG</td><td colspan="4">DISCRETE NOT ON DATA BUS</td><td colspan="2"></td></tr> <tr><td>WATER IN FUEL</td><td colspan="4">SYSTEM CTRLR / DRIVE TRAIN J1939 / CLUSTER</td><td colspan="2">FUEL FILTER</td></tr> <tr><td>COOLANT LEVEL</td><td colspan="4">ENGINE CTRLR / DRIVE TRAIN J1939 / CLUSTER</td><td colspan="2">SURGE TANK</td></tr> <tr><td>CHECK ELECT SYS</td><td colspan="4">SYSTEM CTRLR / DRIVE TRAIN J1939 / CLUSTER</td><td colspan="2"></td></tr> <tr><td>PARK (P)</td><td colspan="4">SYSTEM CTRLR / DRIVE TRAIN J1939 / CLUSTER</td><td colspan="2">SWITCH</td></tr> <tr><td>CRUISE</td><td colspan="4">SYSTEM CTRLR / DRIVE TRAIN J1939 / CLUSTER</td><td colspan="2"></td></tr> <tr><td>ABS</td><td colspan="4">TRUCK CTRLR / DRIVE TRAIN J1939 / CLUSTER</td><td colspan="2"></td></tr> <tr><td>(RIGHT TURN)</td><td colspan="4">SYSTEM CTRLR / DRIVE TRAIN J1939 / CLUSTER</td><td colspan="2"></td></tr> <tr><td>WAIT TO START</td><td colspan="4">ENGINE CTRLR / DRIVE TRAIN J1939 / CLUSTER</td><td colspan="2"></td></tr> <tr><td>FASTEN BELTS</td><td colspan="4">SYSTEM CTRLR / DRIVE TRAIN J1939 / CLUSTER</td><td colspan="2"></td></tr> <tr><td>(HIGH BEAM IND)</td><td colspan="4">SYSTEM CTRLR / DRIVE TRAIN J1939 / CLUSTER</td><td colspan="2"></td></tr> <tr><td>COLD AMB PROT</td><td colspan="4">SYSTEM CTRLR / DRIVE TRAIN J1939 / CLUSTER</td><td colspan="2"></td></tr> <tr><td>RETARD OVERHEAT</td><td colspan="4">TRANS CTRLR / DRIVE TRAIN J1939 / CLUSTER</td><td colspan="2">TRANSMISSION</td></tr> <tr><td>CHECK AC</td><td colspan="4">SYSTEM CTRLR / DRIVE TRAIN J1939 / CLUSTER</td><td colspan="2"></td></tr> <tr><td>AUTO NEUTRAL</td><td colspan="4">DISCRETE NOT ON DATA BUS</td><td colspan="2">SWITCH</td></tr> <tr><td>ALTERNATOR</td><td colspan="4">DISCRETE NOT ON DATA BUS</td><td colspan="2"></td></tr> <tr><td>PTO/THROTTLE</td><td colspan="4">SYSTEM CTRLR / DRIVE TRAIN J1939 / CLUSTER</td><td colspan="2"></td></tr> <tr><td>OPTIMIZED IDLE</td><td colspan="4">DISCRETE NOT ON DATA BUS</td><td colspan="2"></td></tr> <tr><td>SNOW VALVE</td><td colspan="4">DISCRETE NOT ON DATA BUS</td><td colspan="2">SNOW VALVE</td></tr> <tr><td>FR AXLE DIFF LOCK</td><td colspan="4">DISCRETE NOT ON DATA BUS</td><td colspan="2">FWD RR AXLE</td></tr> <tr><td>RR AXLE DIFF LOCK</td><td colspan="4">DISCRETE NOT ON DATA BUS</td><td colspan="2">RR RR AXLE</td></tr> <tr><td>MESSAGE WAIT</td><td colspan="4">DISCRETE NOT ON DATA BUS</td><td colspan="2"></td></tr> <tr><td>PTO</td><td colspan="4">DISCRETE NOT ON DATA BUS</td><td colspan="2"></td></tr> <tr><td>CONVERTER TEMP</td><td colspan="4">DISCRETE NOT ON DATA BUS</td><td colspan="2"></td></tr> <tr><td>TOUCH LOC RELEASE</td><td colspan="4">DISCRETE NOT ON DATA BUS</td><td colspan="2"></td></tr> <tr><td>PARK FLUID</td><td colspan="4">SYSTEM CTRLR/DRIVE TRAIN</td><td colspan="2"></td></tr> <tr><td>FR AXLE ENGAGED</td><td colspan="4">DISCRETE NOT ON DATA BUS</td><td colspan="2">TRANSFER CASE</td></tr> </tbody> </table>							IF WARNING LIGHTS							WARNING LIGHT TITLE	SIGNAL PATH				SENSOR LOCATION		RANGE INHIBITED	TRANS CTRLR / DRIVE TRAIN J1939 / CLUSTER						FUEL FILTER	SYSTEM CTRLR / DRIVE TRAIN J1939 / CLUSTER				FUEL FILTER		ENGINE (YELLOW LED)	ENGINE CTRLR / DRIVE TRAIN J1939 / CLUSTER						ENGINE (RED LED)	ENGINE CTRLR / DRIVE TRAIN J1939 / CLUSTER						BRAKE PRESSURE (O)	SYSTEM CTRLR / DRIVE TRAIN J1939 / CLUSTER				SWITCH		BRAKE FLUID	SYSTEM CTRLR / DRIVE TRAIN J1939 / CLUSTER				BRK RESERVOIR		TRAC CTRL	TRUCK ABS CTRLR / DRIVE TRAIN J1939 / CLUSTER						CHECK TRANS	TRANS CTRLR / DRIVE TRAIN J1939 / CLUSTER						TRAILER ABS	TRLR ABS CTRLR / DRIVE TRAIN J1939 / CLUSTER						WASHER FLUID	SYSTEM CTRLR / DRIVE TRAIN J1939 / CLUSTER				WASHER BOTTLE		(LEFT TURN)	SYSTEM CTRLR / DRIVE TRAIN J1939 / CLUSTER				TURN SIG SW		AIR BAG	DISCRETE NOT ON DATA BUS						WATER IN FUEL	SYSTEM CTRLR / DRIVE TRAIN J1939 / CLUSTER				FUEL FILTER		COOLANT LEVEL	ENGINE CTRLR / DRIVE TRAIN J1939 / CLUSTER				SURGE TANK		CHECK ELECT SYS	SYSTEM CTRLR / DRIVE TRAIN J1939 / CLUSTER						PARK (P)	SYSTEM CTRLR / DRIVE TRAIN J1939 / CLUSTER				SWITCH		CRUISE	SYSTEM CTRLR / DRIVE TRAIN J1939 / CLUSTER						ABS	TRUCK CTRLR / DRIVE TRAIN J1939 / CLUSTER						(RIGHT TURN)	SYSTEM CTRLR / DRIVE TRAIN J1939 / CLUSTER						WAIT TO START	ENGINE CTRLR / DRIVE TRAIN J1939 / CLUSTER						FASTEN BELTS	SYSTEM CTRLR / DRIVE TRAIN J1939 / CLUSTER						(HIGH BEAM IND)	SYSTEM CTRLR / DRIVE TRAIN J1939 / CLUSTER						COLD AMB PROT	SYSTEM CTRLR / DRIVE TRAIN J1939 / CLUSTER						RETARD OVERHEAT	TRANS CTRLR / DRIVE TRAIN J1939 / CLUSTER				TRANSMISSION		CHECK AC	SYSTEM CTRLR / DRIVE TRAIN J1939 / CLUSTER						AUTO NEUTRAL	DISCRETE NOT ON DATA BUS				SWITCH		ALTERNATOR	DISCRETE NOT ON DATA BUS						PTO/THROTTLE	SYSTEM CTRLR / DRIVE TRAIN J1939 / CLUSTER						OPTIMIZED IDLE	DISCRETE NOT ON DATA BUS						SNOW VALVE	DISCRETE NOT ON DATA BUS				SNOW VALVE		FR AXLE DIFF LOCK	DISCRETE NOT ON DATA BUS				FWD RR AXLE		RR AXLE DIFF LOCK	DISCRETE NOT ON DATA BUS				RR RR AXLE		MESSAGE WAIT	DISCRETE NOT ON DATA BUS						PTO	DISCRETE NOT ON DATA BUS						CONVERTER TEMP	DISCRETE NOT ON DATA BUS						TOUCH LOC RELEASE	DISCRETE NOT ON DATA BUS						PARK FLUID	SYSTEM CTRLR/DRIVE TRAIN						FR AXLE ENGAGED	DISCRETE NOT ON DATA BUS				TRANSFER CASE	
IF WARNING LIGHTS																																																																																																																																																																																																																																																																																														
WARNING LIGHT TITLE	SIGNAL PATH				SENSOR LOCATION																																																																																																																																																																																																																																																																																									
RANGE INHIBITED	TRANS CTRLR / DRIVE TRAIN J1939 / CLUSTER																																																																																																																																																																																																																																																																																													
FUEL FILTER	SYSTEM CTRLR / DRIVE TRAIN J1939 / CLUSTER				FUEL FILTER																																																																																																																																																																																																																																																																																									
ENGINE (YELLOW LED)	ENGINE CTRLR / DRIVE TRAIN J1939 / CLUSTER																																																																																																																																																																																																																																																																																													
ENGINE (RED LED)	ENGINE CTRLR / DRIVE TRAIN J1939 / CLUSTER																																																																																																																																																																																																																																																																																													
BRAKE PRESSURE (O)	SYSTEM CTRLR / DRIVE TRAIN J1939 / CLUSTER				SWITCH																																																																																																																																																																																																																																																																																									
BRAKE FLUID	SYSTEM CTRLR / DRIVE TRAIN J1939 / CLUSTER				BRK RESERVOIR																																																																																																																																																																																																																																																																																									
TRAC CTRL	TRUCK ABS CTRLR / DRIVE TRAIN J1939 / CLUSTER																																																																																																																																																																																																																																																																																													
CHECK TRANS	TRANS CTRLR / DRIVE TRAIN J1939 / CLUSTER																																																																																																																																																																																																																																																																																													
TRAILER ABS	TRLR ABS CTRLR / DRIVE TRAIN J1939 / CLUSTER																																																																																																																																																																																																																																																																																													
WASHER FLUID	SYSTEM CTRLR / DRIVE TRAIN J1939 / CLUSTER				WASHER BOTTLE																																																																																																																																																																																																																																																																																									
(LEFT TURN)	SYSTEM CTRLR / DRIVE TRAIN J1939 / CLUSTER				TURN SIG SW																																																																																																																																																																																																																																																																																									
AIR BAG	DISCRETE NOT ON DATA BUS																																																																																																																																																																																																																																																																																													
WATER IN FUEL	SYSTEM CTRLR / DRIVE TRAIN J1939 / CLUSTER				FUEL FILTER																																																																																																																																																																																																																																																																																									
COOLANT LEVEL	ENGINE CTRLR / DRIVE TRAIN J1939 / CLUSTER				SURGE TANK																																																																																																																																																																																																																																																																																									
CHECK ELECT SYS	SYSTEM CTRLR / DRIVE TRAIN J1939 / CLUSTER																																																																																																																																																																																																																																																																																													
PARK (P)	SYSTEM CTRLR / DRIVE TRAIN J1939 / CLUSTER				SWITCH																																																																																																																																																																																																																																																																																									
CRUISE	SYSTEM CTRLR / DRIVE TRAIN J1939 / CLUSTER																																																																																																																																																																																																																																																																																													
ABS	TRUCK CTRLR / DRIVE TRAIN J1939 / CLUSTER																																																																																																																																																																																																																																																																																													
(RIGHT TURN)	SYSTEM CTRLR / DRIVE TRAIN J1939 / CLUSTER																																																																																																																																																																																																																																																																																													
WAIT TO START	ENGINE CTRLR / DRIVE TRAIN J1939 / CLUSTER																																																																																																																																																																																																																																																																																													
FASTEN BELTS	SYSTEM CTRLR / DRIVE TRAIN J1939 / CLUSTER																																																																																																																																																																																																																																																																																													
(HIGH BEAM IND)	SYSTEM CTRLR / DRIVE TRAIN J1939 / CLUSTER																																																																																																																																																																																																																																																																																													
COLD AMB PROT	SYSTEM CTRLR / DRIVE TRAIN J1939 / CLUSTER																																																																																																																																																																																																																																																																																													
RETARD OVERHEAT	TRANS CTRLR / DRIVE TRAIN J1939 / CLUSTER				TRANSMISSION																																																																																																																																																																																																																																																																																									
CHECK AC	SYSTEM CTRLR / DRIVE TRAIN J1939 / CLUSTER																																																																																																																																																																																																																																																																																													
AUTO NEUTRAL	DISCRETE NOT ON DATA BUS				SWITCH																																																																																																																																																																																																																																																																																									
ALTERNATOR	DISCRETE NOT ON DATA BUS																																																																																																																																																																																																																																																																																													
PTO/THROTTLE	SYSTEM CTRLR / DRIVE TRAIN J1939 / CLUSTER																																																																																																																																																																																																																																																																																													
OPTIMIZED IDLE	DISCRETE NOT ON DATA BUS																																																																																																																																																																																																																																																																																													
SNOW VALVE	DISCRETE NOT ON DATA BUS				SNOW VALVE																																																																																																																																																																																																																																																																																									
FR AXLE DIFF LOCK	DISCRETE NOT ON DATA BUS				FWD RR AXLE																																																																																																																																																																																																																																																																																									
RR AXLE DIFF LOCK	DISCRETE NOT ON DATA BUS				RR RR AXLE																																																																																																																																																																																																																																																																																									
MESSAGE WAIT	DISCRETE NOT ON DATA BUS																																																																																																																																																																																																																																																																																													
PTO	DISCRETE NOT ON DATA BUS																																																																																																																																																																																																																																																																																													
CONVERTER TEMP	DISCRETE NOT ON DATA BUS																																																																																																																																																																																																																																																																																													
TOUCH LOC RELEASE	DISCRETE NOT ON DATA BUS																																																																																																																																																																																																																																																																																													
PARK FLUID	SYSTEM CTRLR/DRIVE TRAIN																																																																																																																																																																																																																																																																																													
FR AXLE ENGAGED	DISCRETE NOT ON DATA BUS				TRANSFER CASE																																																																																																																																																																																																																																																																																									
CHR	DATE	CHANGE	REV	REFERENCE	DRAWN	NAME																																																																																																																																																																																																																																																																																								
CNA1	26JUL11	INITIAL RELEASE.	A	80257V	U00KDD2	CIRCUIT DIAGRAM, TERRASTAR																																																																																																																																																																																																																																																																																								
					RELEASE NO.	DATE																																																																																																																																																																																																																																																																																								
					80257V	24JUN11																																																																																																																																																																																																																																																																																								
						PART NO.																																																																																																																																																																																																																																																																																								
						AE08064599																																																																																																																																																																																																																																																																																								
						007																																																																																																																																																																																																																																																																																								

Figure 90 Warning Lights List

8.8. WARNING LIGHTS CONTROLLING BY ENGINE, TRANSMISSION, ABS CONTROLLER, P. 8

<p>NAVISTAR, INC THIS PRINT IS PROVIDED ON A RESTRICTED BASIS AND IS NOT TO BE USED IN ANY WAY DETRIMENTAL TO THE INTEREST OF NAVISTAR, INC.</p>				<p>ELECTRICAL CIRCUIT CHAPTER CHAPTER 8 WARNING LIGHTS CONTROLLED BY ENGINE, TRANSMISSION, ABS CONTROLLER</p>			
<p>THE FOLLOWING WARNING LIGHTS ARE CONTROLLED BY THE ENGINE, TRANSMISSION, OR ABS CONTROLLER OVER THE DATA BUS AND DO NOT HAVE INDEPENDENT CIRCUITS THAT CAN BE OR NEEDS TO BE SHOWN:</p> <p>DO NOT SHIPT</p> <p>ENGINE (YELLOW LENS)</p> <p>ENGINE (RED LENS)</p> <p>TRAC CTRL</p> <p>CHECK TRANS</p> <p>TRAILER ABS</p> <p>CHECK ELECTR SYS</p> <p>ABS</p> <p>WAIT TO START</p> <p>RETARD OVERHEAT</p> <p>AUTO NEUTRAL</p> <p>OPTIMIZED IDLE</p>							
CHK	DATE	CHANGE	REV	REFERENCE	DRWN	NAME	
CNA1	26JUL11	INITIAL RELEASE.	A	80257V	U00KDD2	CIRCUIT DIAGRAM, TERRASTAR	
					RELEASE NO.	DATE	
					80257V	24JUN11	
						PART NO.	
						AE08064599	
						SHEET	
						008	

Figure 91 Warning Lights Controlling by Engine, Transmission, ABS Controller

8.9. ENGINE OIL PRESS & TEMP, SPEEDOMETER, TACH, VOLTMETER & WATER TEMP GAUGE CIRCUITS, P. 9

<p style="text-align: center;">NAVISTAR, INC</p> <p style="font-size: small;">THIS PRINT IS PROVIDED ON A RESTRICTED BASIS AND IS NOT TO BE USED IN ANY WAY DETRIMENTAL TO THE INTEREST OF NAVISTAR, INC.</p>	<p style="text-align: center;">ELECTRICAL CIRCUIT DIAGRAM 8 CHAPTER 8</p> <p style="text-align: center;">ENG OIL PRESS & TEMP, SPEEDOMETER, TACH, VOLTMETER & WATER TEMP GAUGE CIRCUITS</p>					
<p>REFER TO CONSOLIDATED ENGINE / VEHICLE CONTROLLER DIAGNOSTICS MANUAL EGES-175 (DT466E), EGES-190 (T444E), FOR CIRCUIT DIAGRAMS SHOWING INPUT CIRCUIT FOR THE FOLLOWING DATALINK DRIVEN SYSTEM:</p> <p>ENGINE OIL PRESSURE GAUGE</p> <p>ENGINE OIL TEMPERATURE GAUGE</p> <p>SPEEDOMETER GAUGE</p> <p>TACHOMETER GAUGE</p> <p>WATER TEMPERATURE GAUGE</p>						
<small>CHK</small>	<small>DATE</small>	<small>CHANGE</small>	<small>REV</small>	<small>REFERENCE</small>	<small>DRAWN</small>	<small>NAME</small>
CNA1	26JUL11	INITIAL RELEASE.	A	80257V	UOOKDD2	CIRCUIT DIAGRAM, TERRASTAR
					<small>RELEASE NO.</small>	<small>DATE</small>
					80257V	21JUL11
						<small>PART NO.</small>
						AE08064599
						<small>SHEET</small>
						009

Figure 92 Engine Oil Press & Temp, Speedometer, Tach, Voltmeter & Water Temp Gauge Circuits

8.10. FUEL GAUGE CIRCUITRY (SINGLE TANK AND DUAL TANK), P. 10

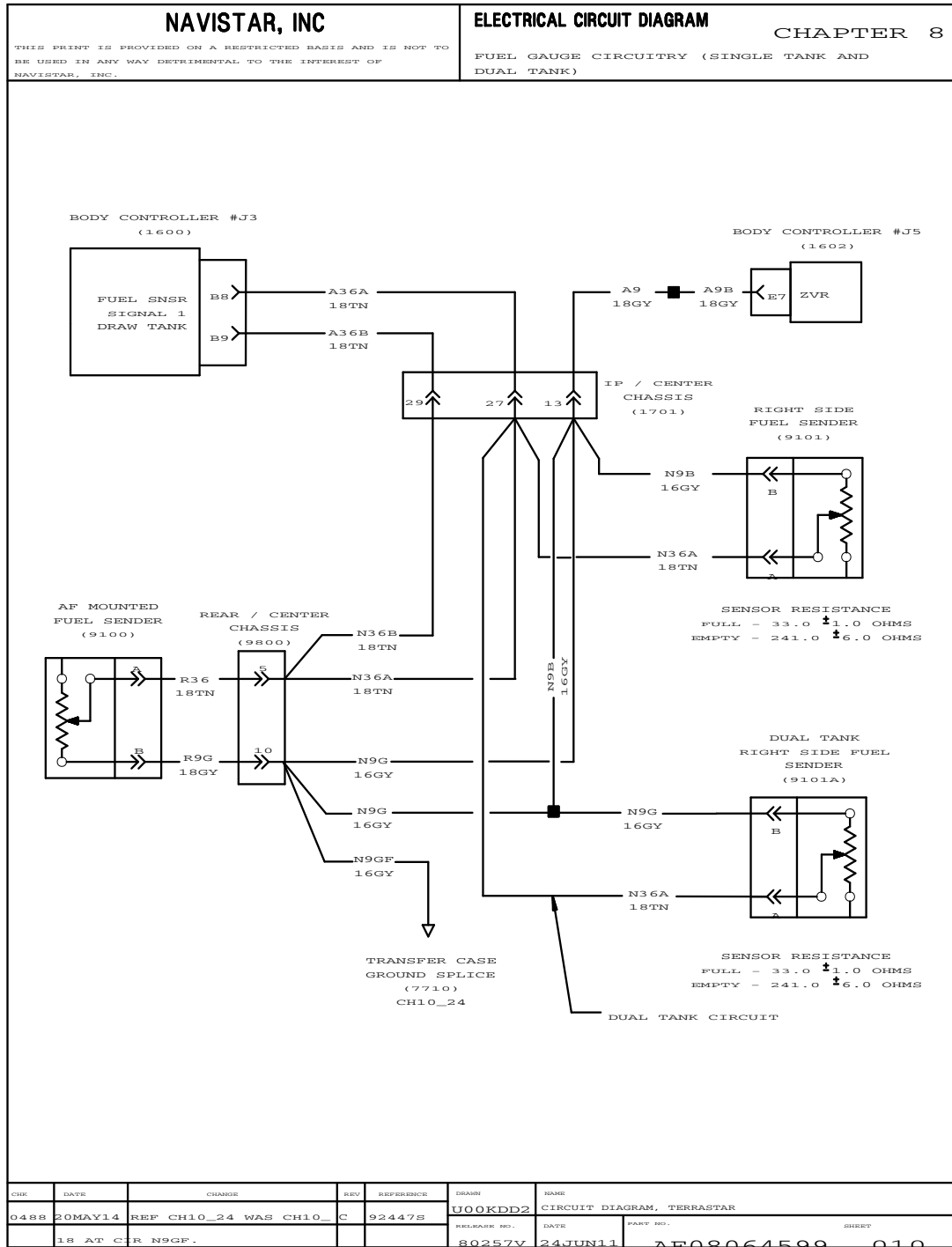

Figure 93 Fuel Gauge Circuitry (Single Tank and Dual Tank)

LIGHTS (CHAPTER 9)

9.1. BACK-UP – WITH ALLISON TRANSMISSION, P. 1

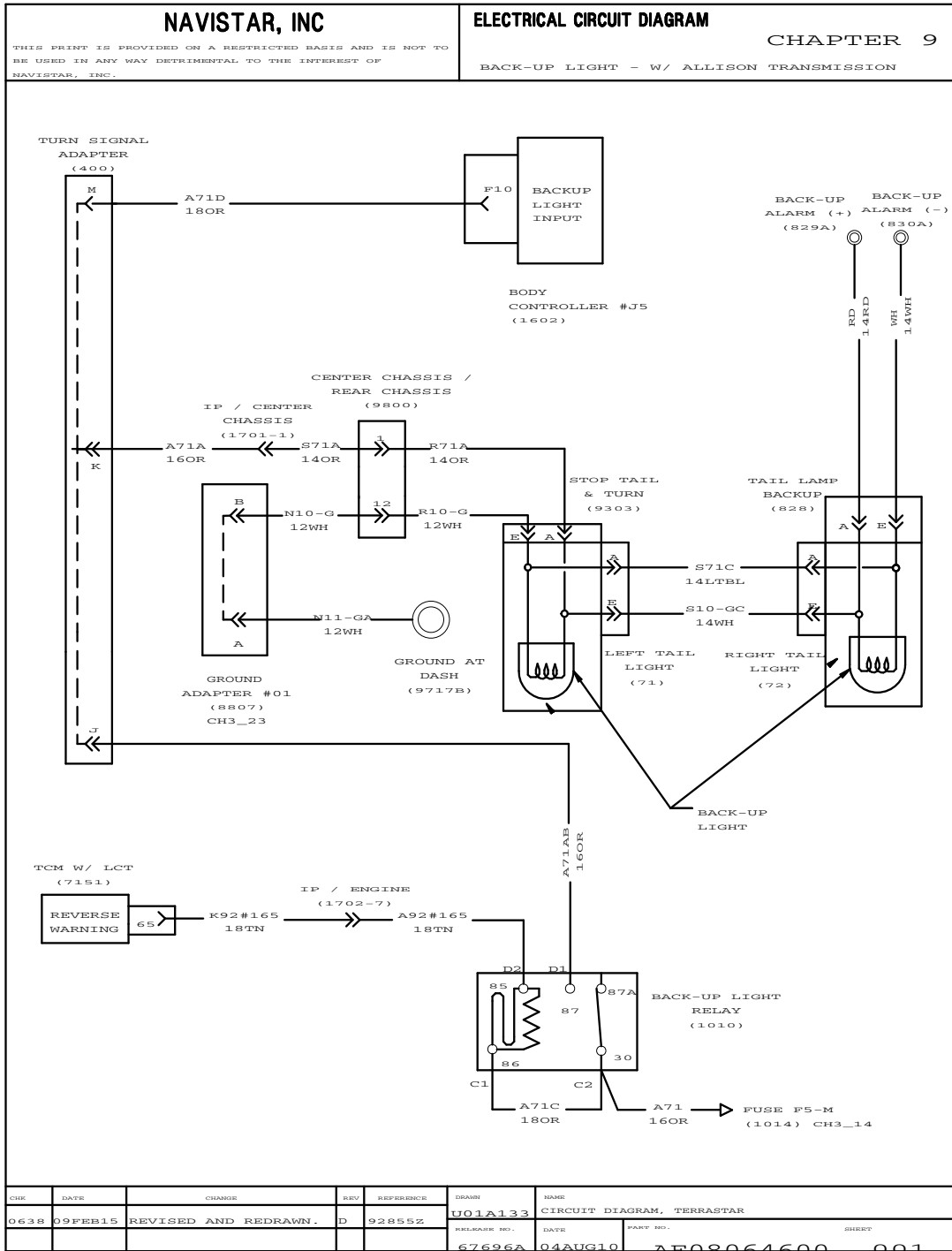

Figure 94 Back-Up – with Allison Transmission

9.2. LIGHT SYSTEM – CLEARANCE, MARKER, PARK, TAIL, TURN & STOP LIGHTS, P. 2

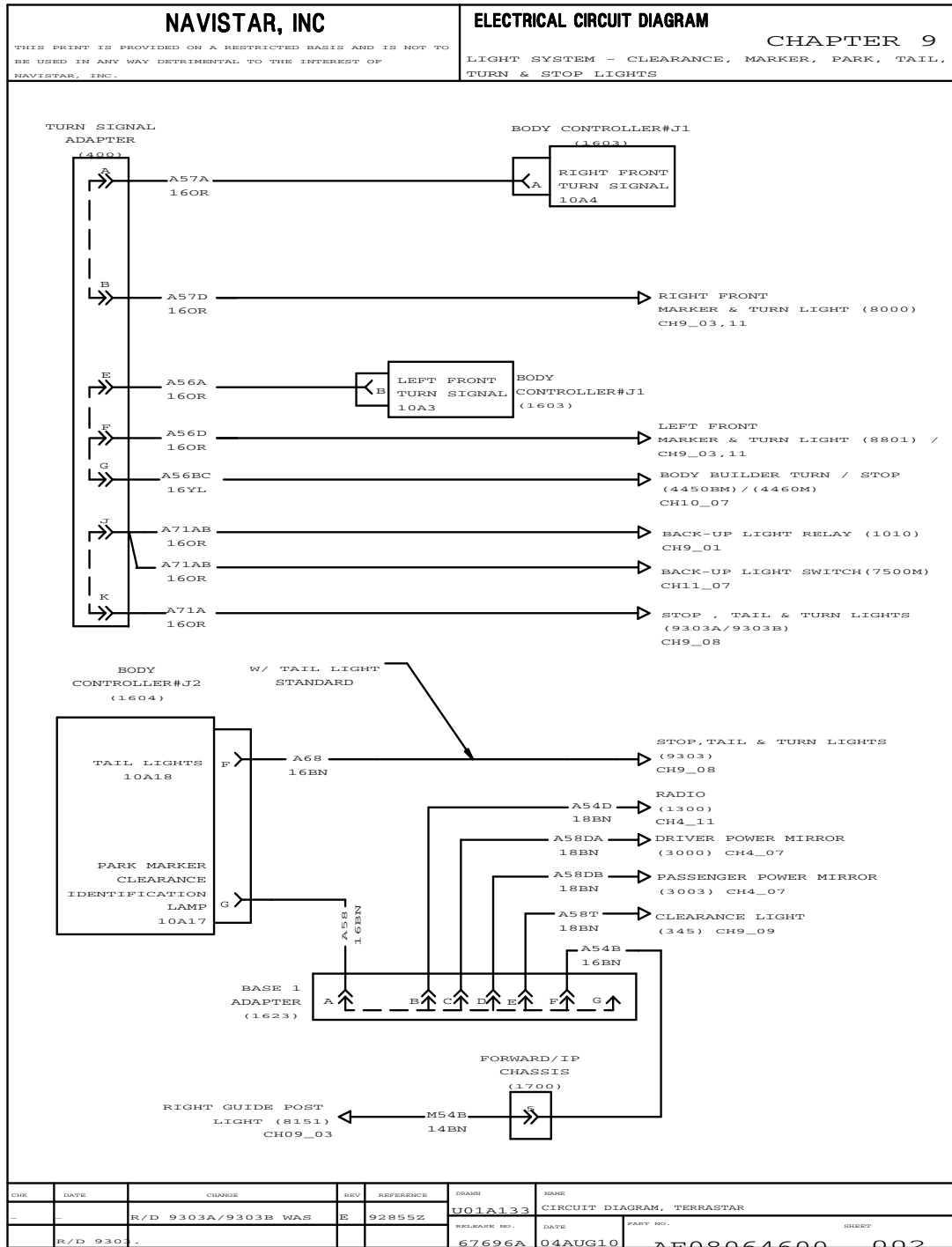

Figure 95 Light System – Clearance, Marker, Park, Tail, Turn & Stop Lights

9.3. LIGHT SYSTEM – CLEARANCE, MARKER, PARK, TAIL, TURN & STOP LIGHTS (CONT.), P. 3

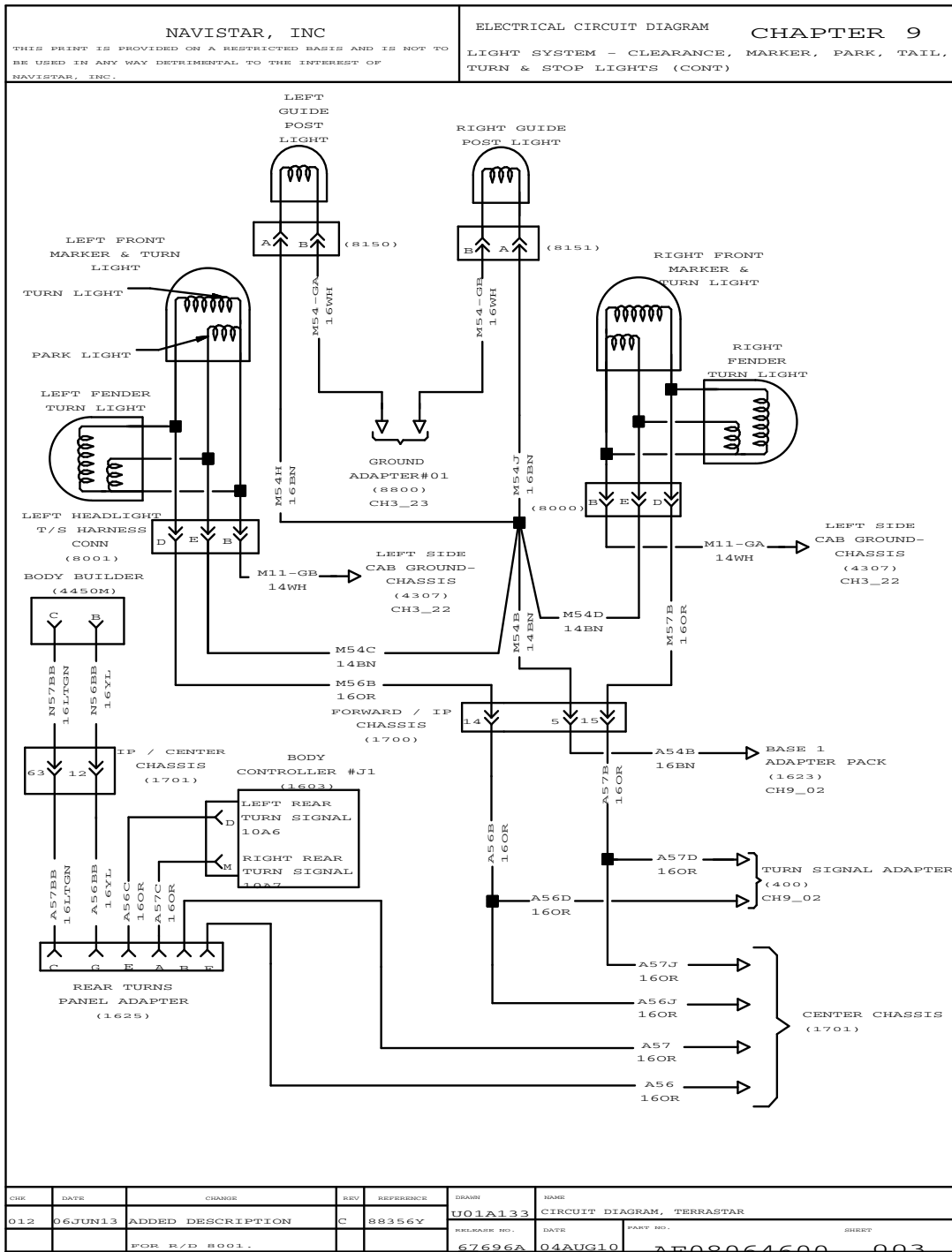

Figure 96 Light System – Clearance, Marker, Park, Tail, Turn & Stop Lights (Cont.)

9.4. LIGHT SYSTEM, FOG LIGHT, P. 4

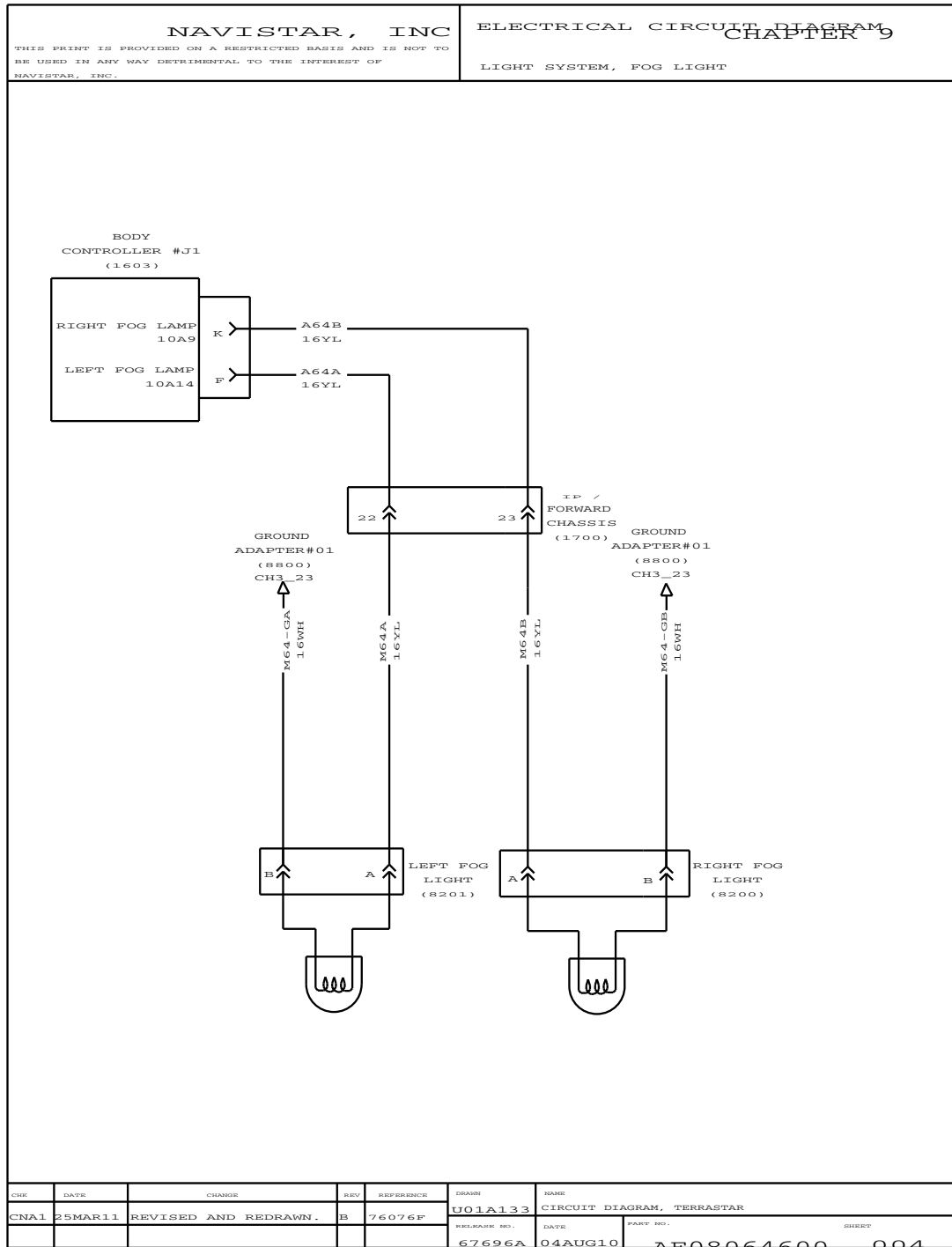

Figure 97 Light System, Fog Light

9.5. HEADLIGHTS, P. 5

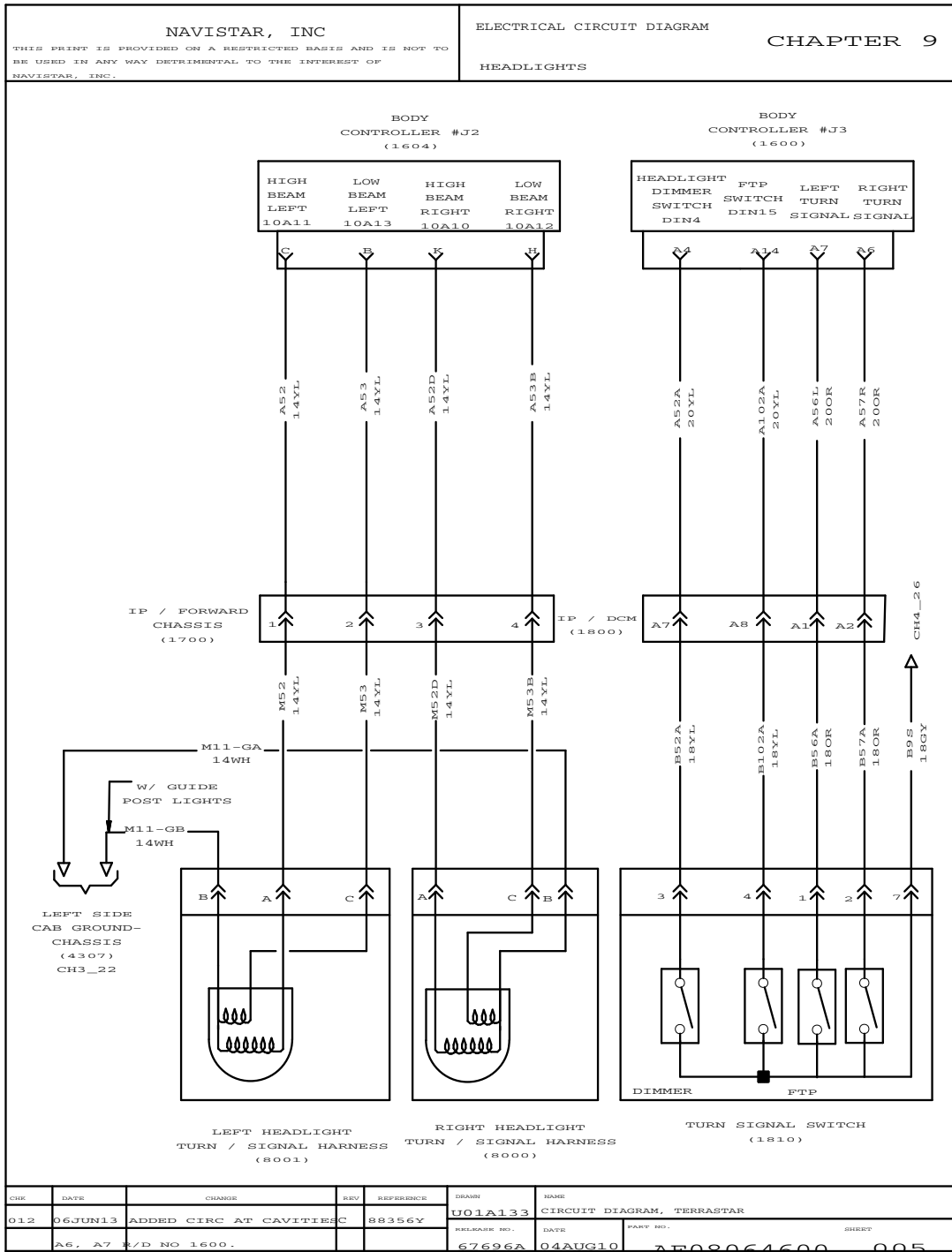

Figure 98 Headlights

9.6. PANEL LIGHTS, P. 6

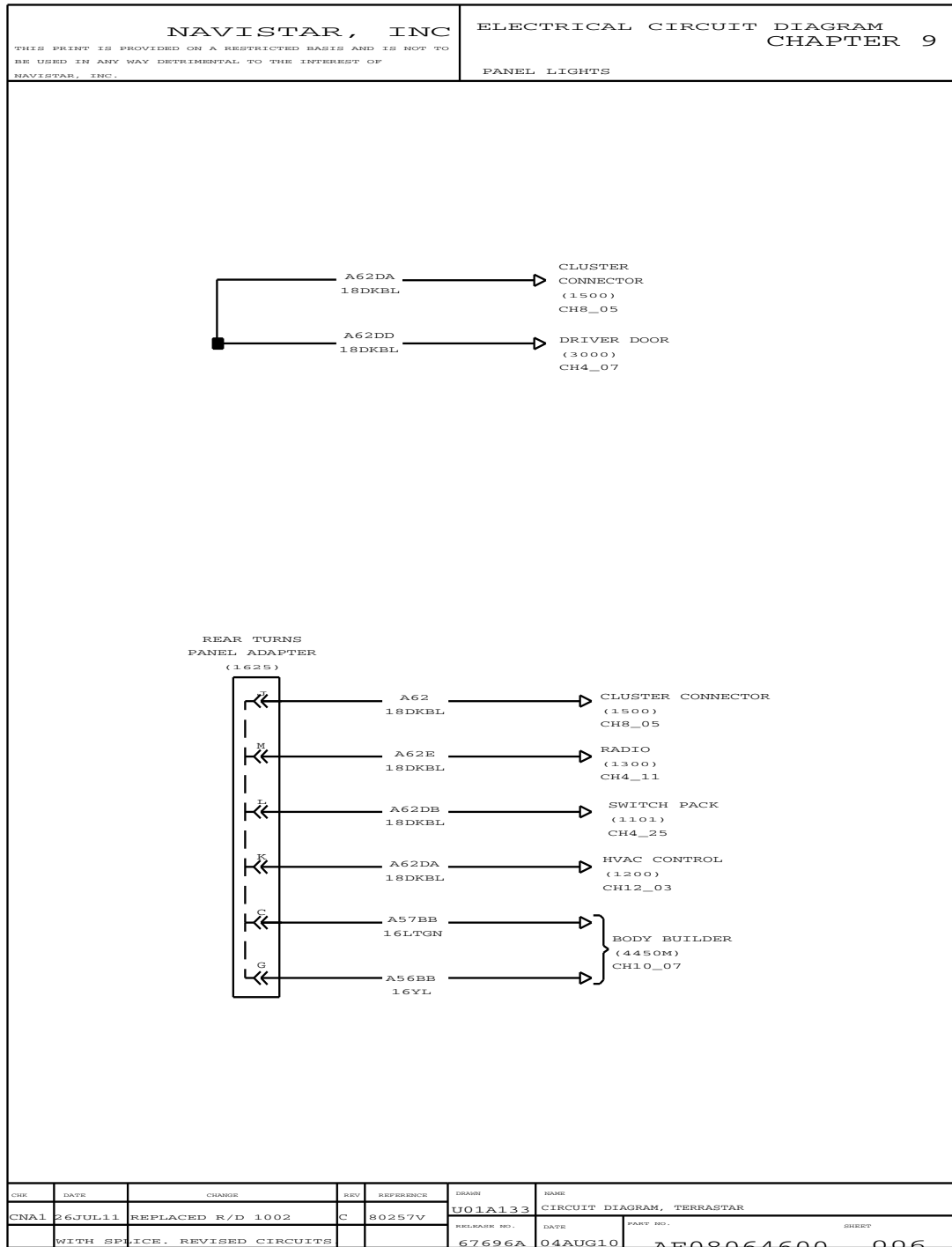

Figure 99 Panel Lights

9.8. LIGHT SYSTEM – CLEARANCE, MARKER, PARK, TAIL, TURN & STOP LIGHTS (CONT.), P. 8

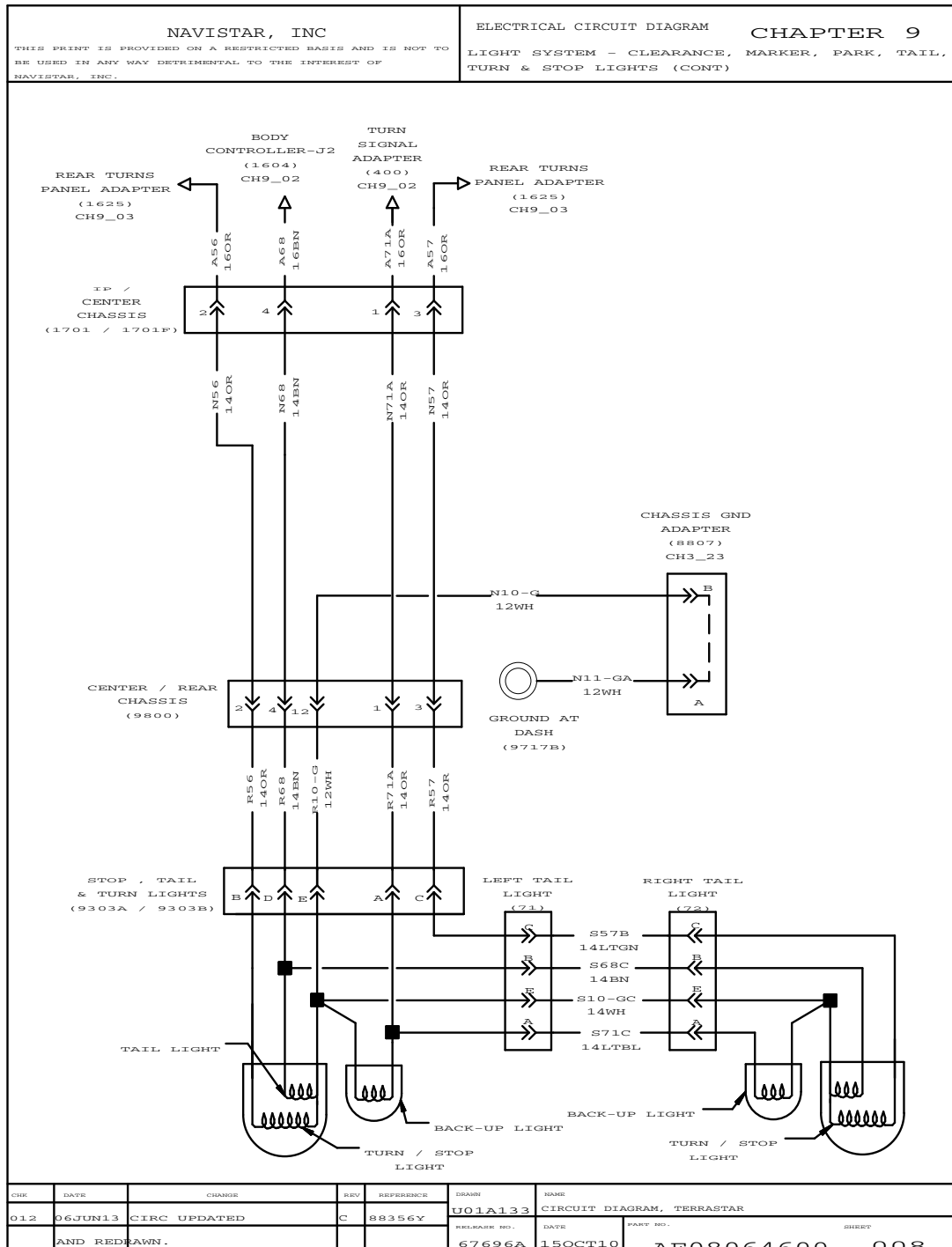

Figure 101 Light System – Clearance, Marker, Park, Tail, Turn & Stop Lights (Cont.)

9.9. LIGHT SYSTEM – CLEARANCE, MARKER, PARK, TAIL, TURN & STOP LIGHTS (CONT.), P. 9

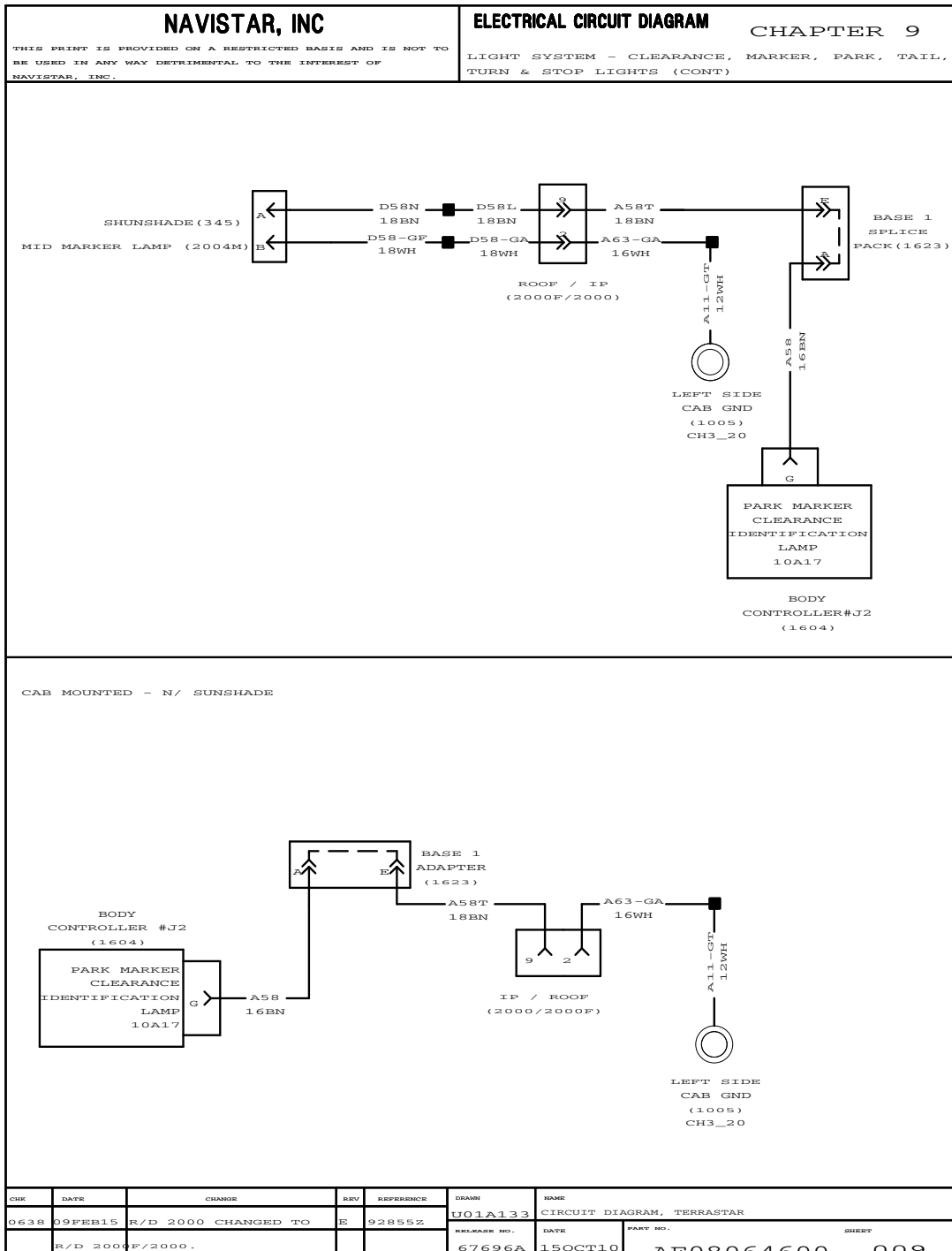

Figure 102 Light System – Clearance, Marker, Park, Tail, Turn & Stop Lights (Cont.)

9.10. AUX HEADLIGHTS, SNOWPLOW LIGHTS, P. 10

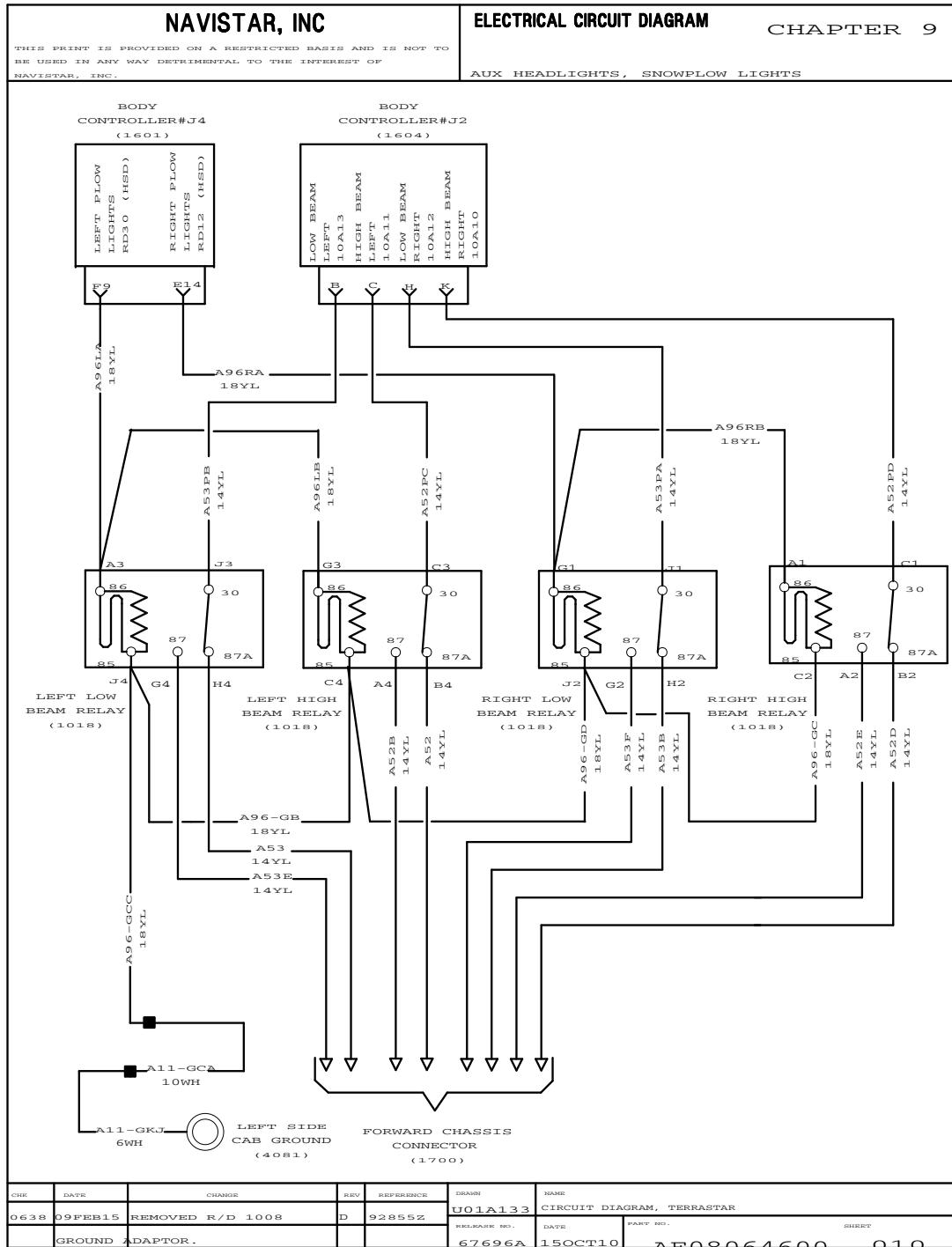

Figure 103 Aux Headlights, Snowplow Lights

9.11. AUX HEADLIGHTS, SNOWPLOW LIGHTS (CONT.), P. 11

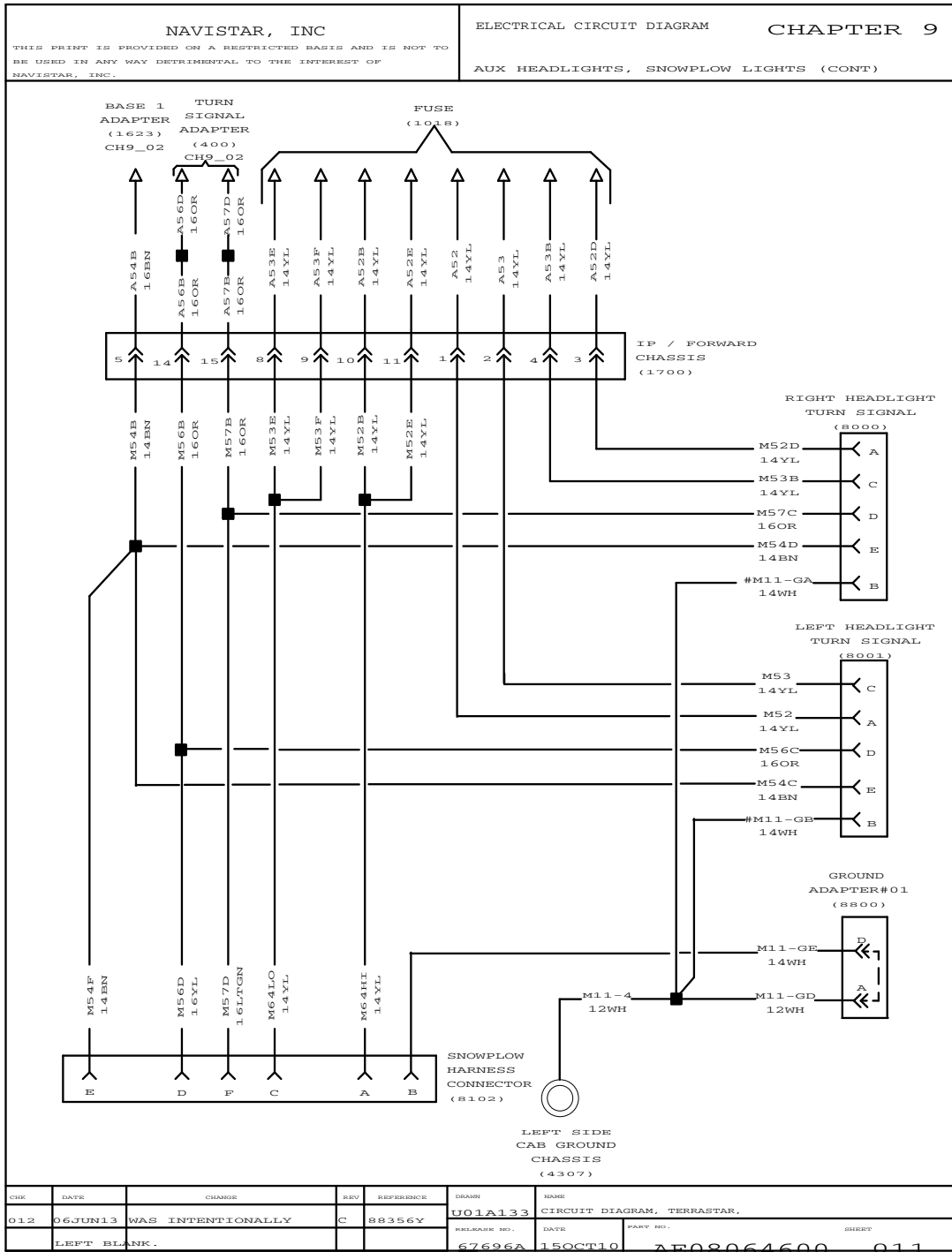

Figure 104 Aux Headlights, Snowplow Lights (Cont.)

9.12. DOME LIGHT SYSTEM, P. 12

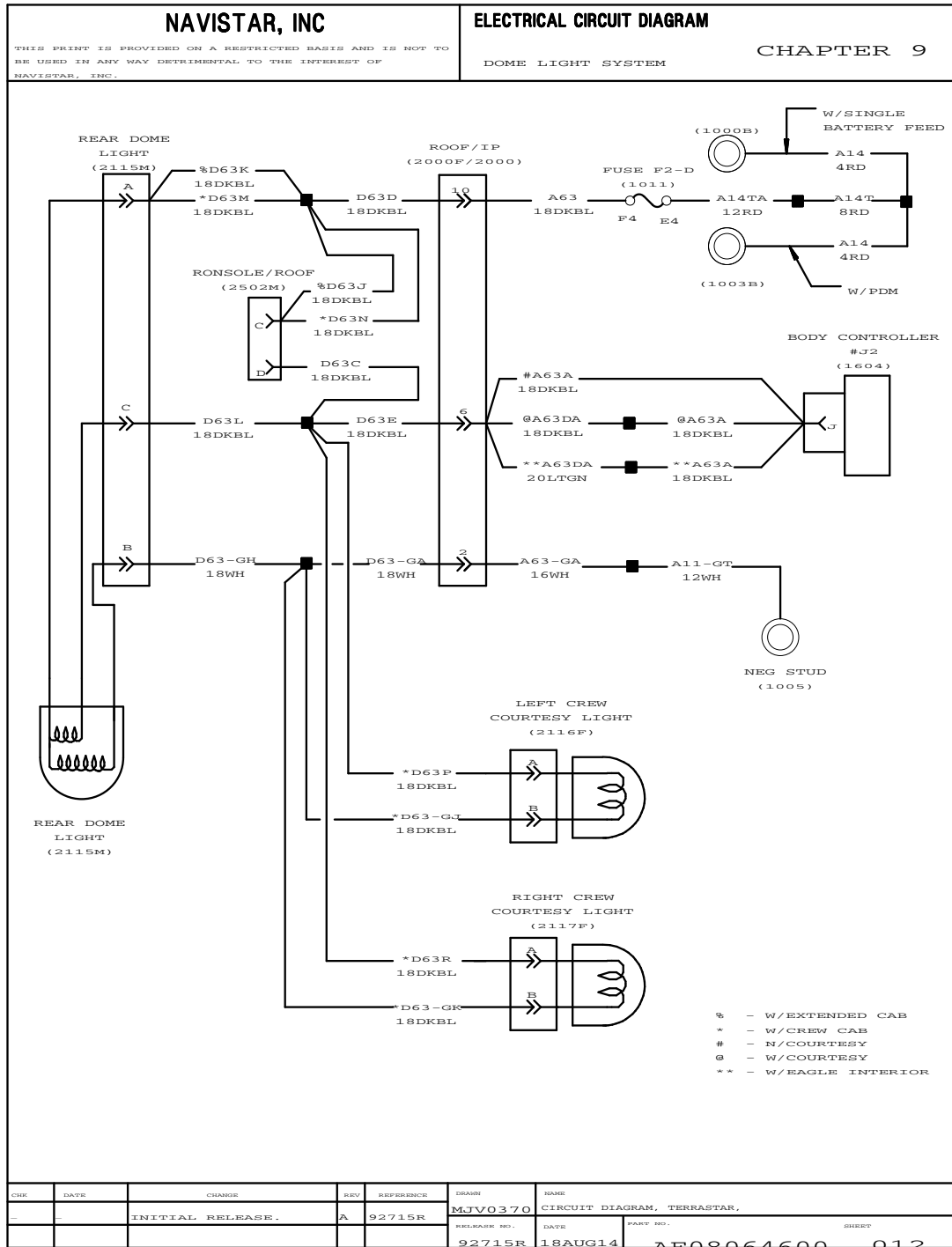

Figure 105 Dome Light System

9.13. CLEARANCE AND MARKER LIGHT, P. 13

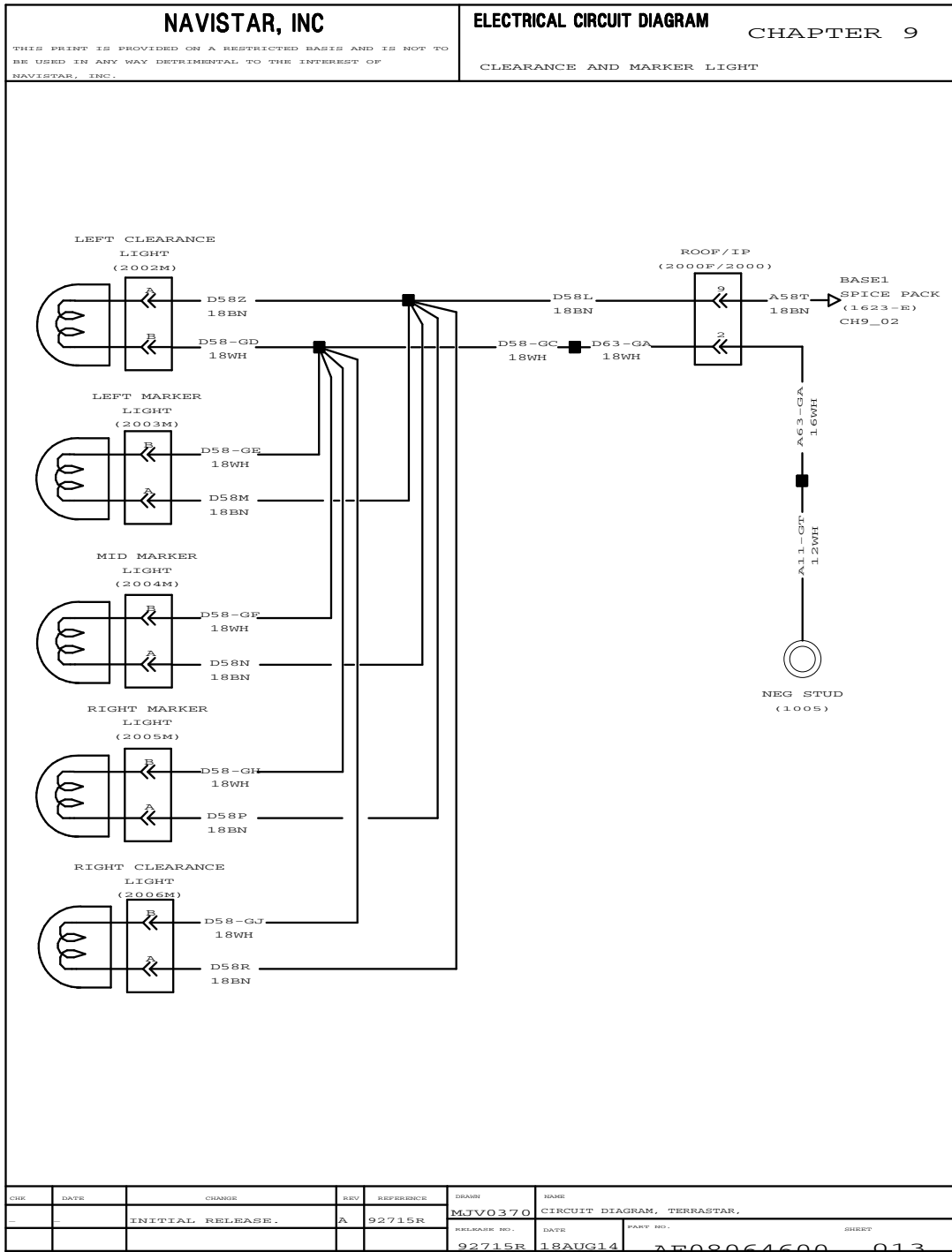

Figure 106 Clearance and Marker Light

CHASSIS ACCESSORIES (CHAPTER 10)

10.1. TRW ABS BRAKES, P. 1

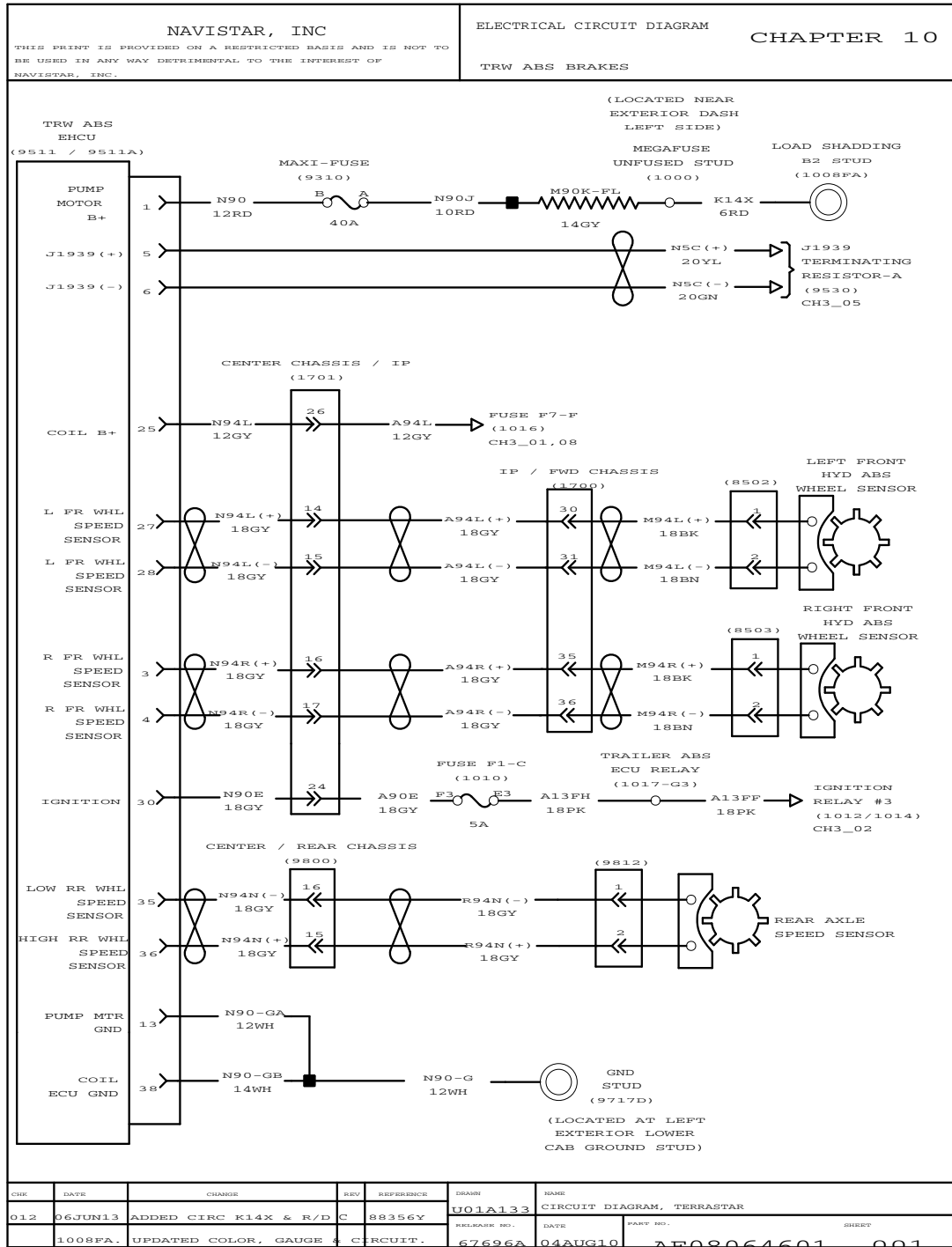

Figure 107 TRW ABS Brakes

10.2. TRW ABS BRAKES (CONT.), P. 2

NAVISTAR, INC <small>THIS PRINT IS PROVIDED ON A RESTRICTED BASIS AND IS NOT TO BE USED IN ANY WAY DETRIMENTAL TO THE INTEREST OF NAVISTAR, INC.</small>				ELECTRICAL CIRCUIT DIAGRAM CHAPTER 10 TRW ABS BRAKES (CONT)			
<h1 style="margin: 0;">INTENTIONALLY LEFT BLANK</h1>							
CHK	DATE	CHANGE	REV	REFERENCE	DRAWN	NAME	
	CN1 25MAR11	REMOVED GEOMETRY.	B	76076F	U01A133	CIRCUIT DIAGRAM, TERRASTAR	
					RELEASE NO.	DATE	
					67696A	04AUG10	
						PART NO.	
						AE08064601	
						SHEET	
						002	

Figure 108 TRW ABS Brakes (Cont.)

10.3. TRW ABS BRAKES (CONT.), P. 3

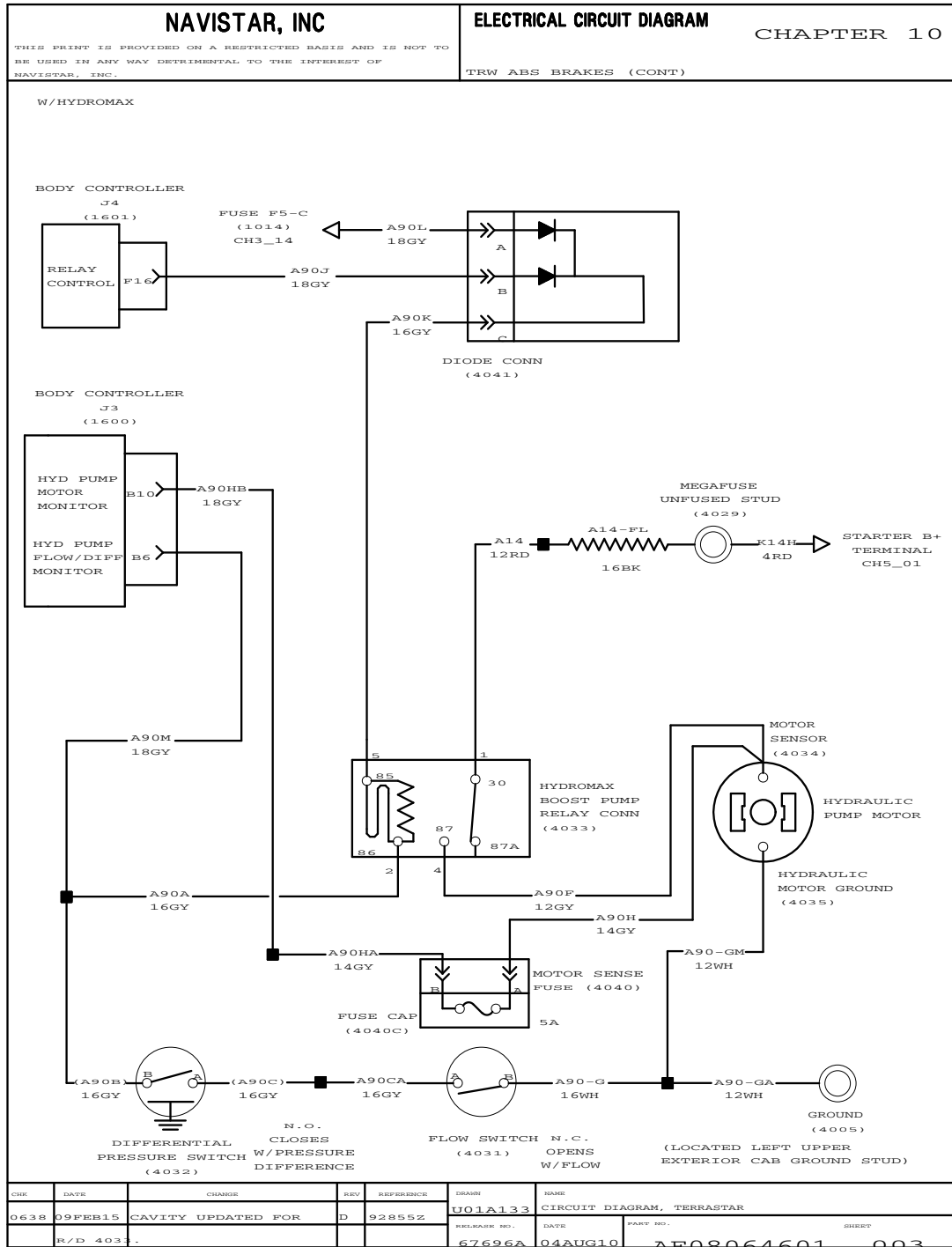

Figure 109 TRW ABS Brakes (Cont.)

10.4. BODY BUILDER AND TRAILER – TURN, MARKERS AND STOP , P. 4

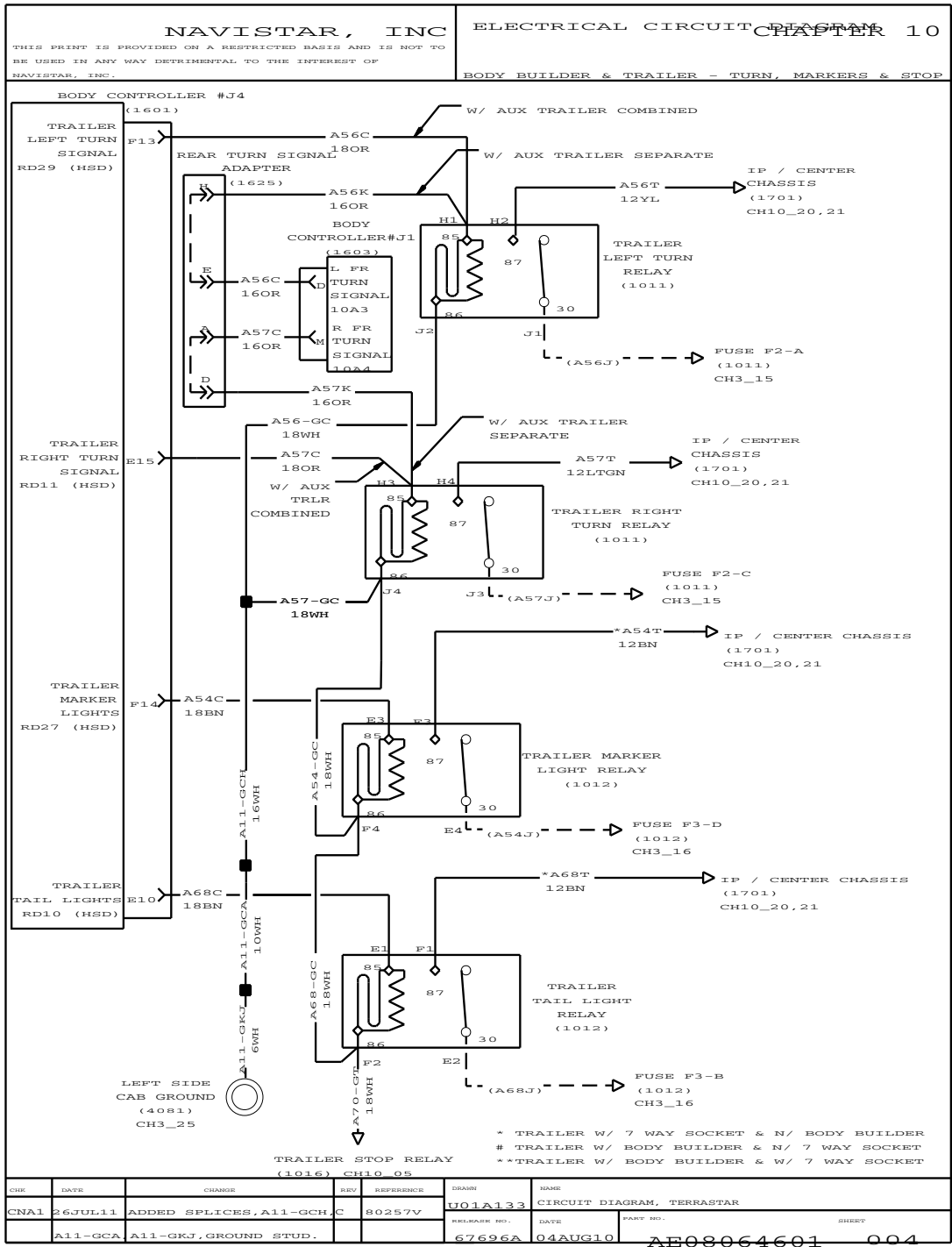

Figure 110 Body Builder and Trailer – Turn, Markers and Stop

10.5. BODY BUILDER AND TRAILER – TURN, MARKERS AND STOP (CONT.), P. 5

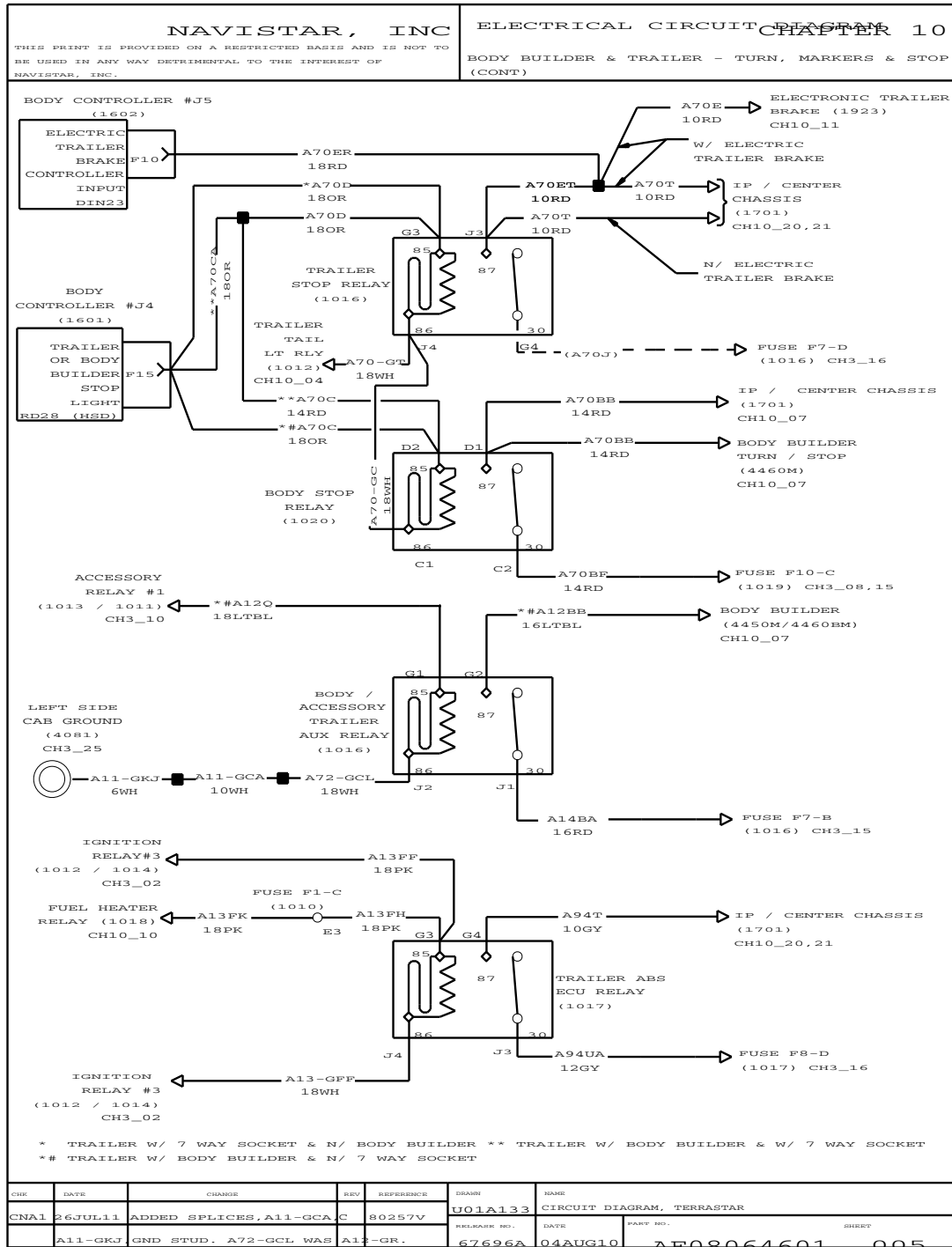

Figure 111 Body Builder & Trailer – Turn, Markers & Stop (Cont.)

10.6. BODY BUILDER ACC FEED WIRING, P. 6

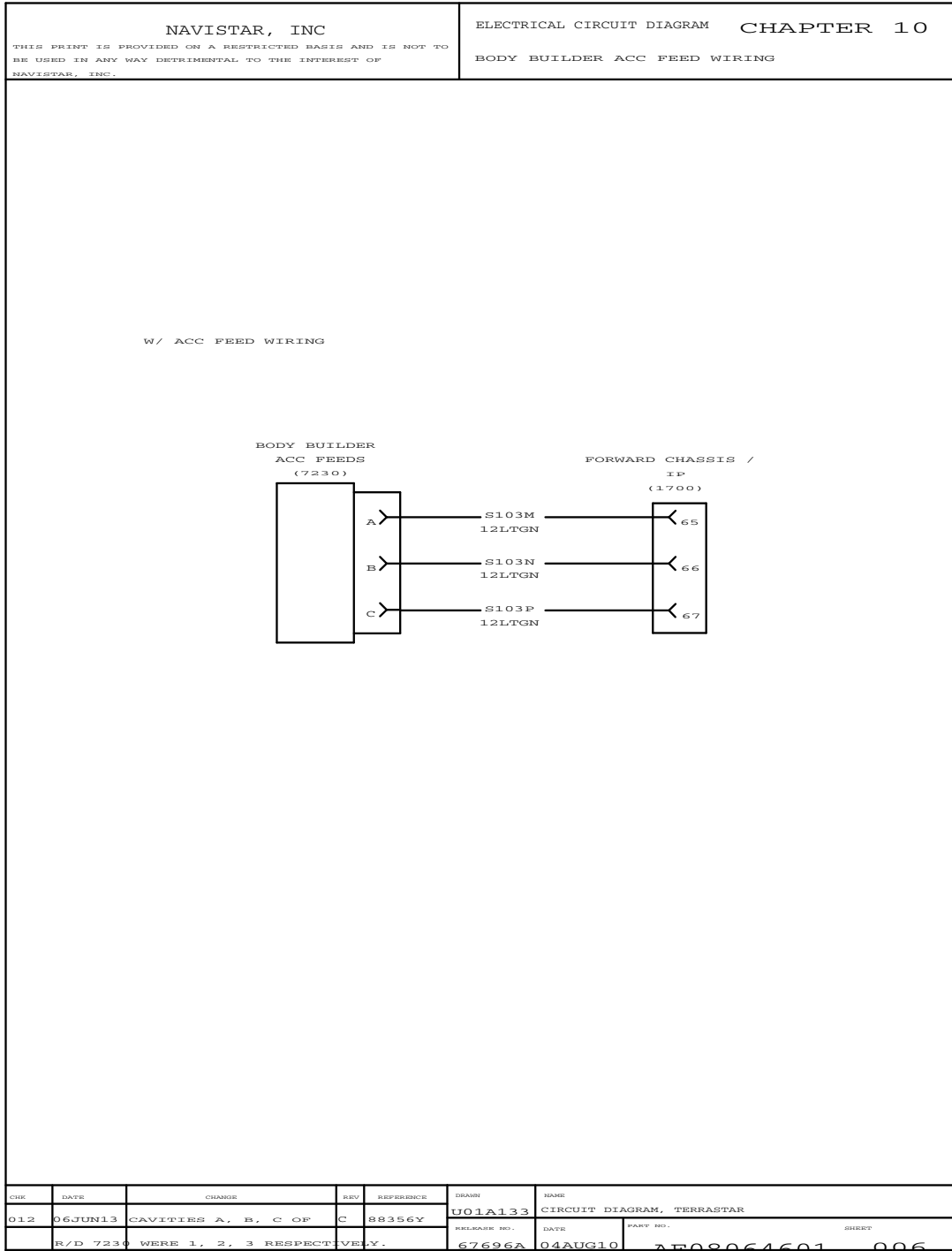

Figure 112 Body Builder ACC Feed Wiring

10.7. BODY BUILDER CONNECTIONS, P. 7

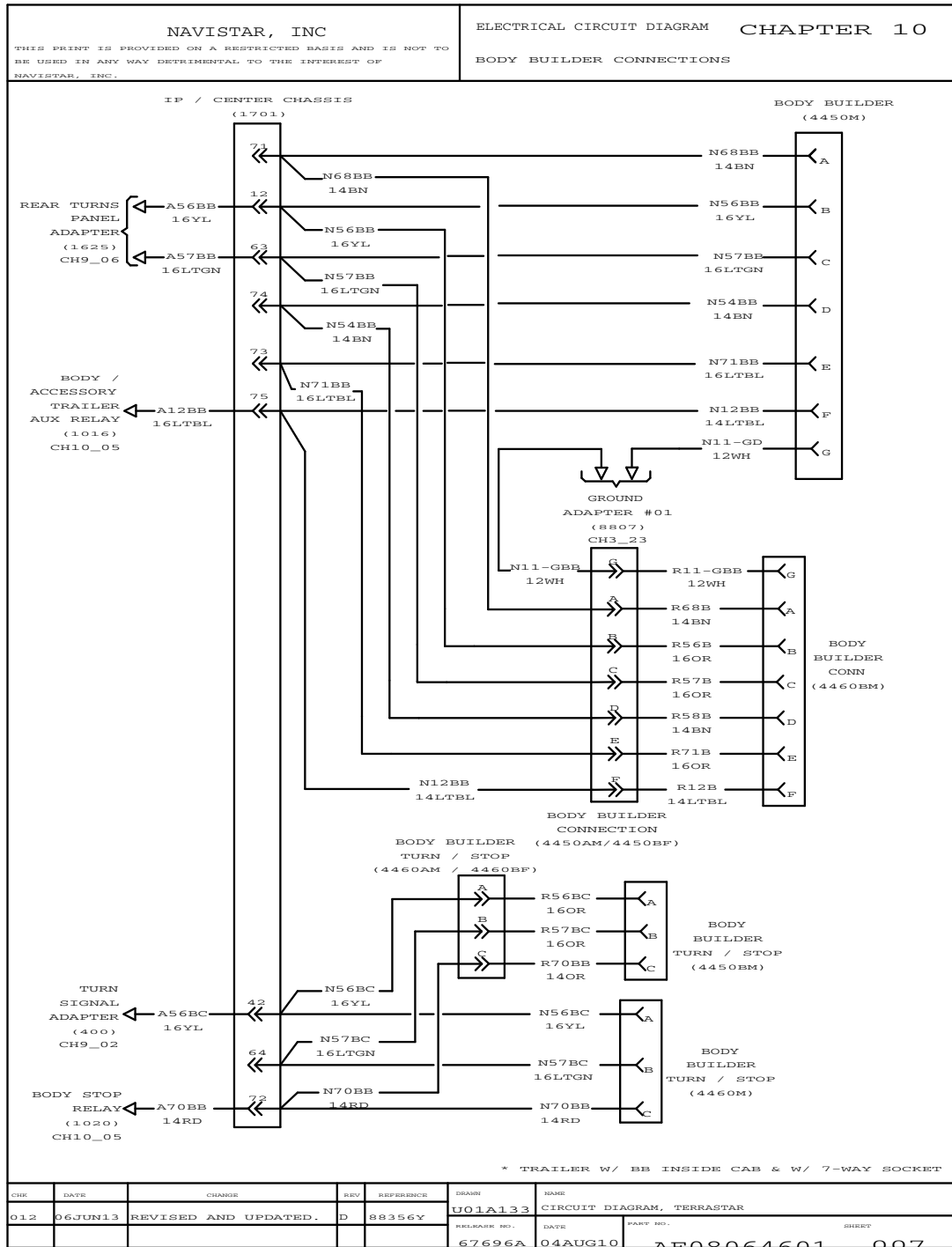

Figure 113 Body Builder Connections

10.8. INTENTIONALLY LEFT BLANK, P. 8

<p>NAVISTAR, INC</p> <p>THIS PRINT IS PROVIDED ON A RESTRICTED BASIS AND IS NOT TO BE USED IN ANY WAY DETRIMENTAL TO THE INTEREST OF NAVISTAR, INC.</p>				<p>ELECTRICAL CIRCUIT DIAGRAM CHAPTER 10</p> <p>TWO SPEED AXLE SWITCH</p>			
<p>INTENTIONALLY LEFT BLANK</p>							
CHR	DATE	CHANGE	REV	REFERENCE	DRAWN	NAME	
CNA1	25MAR11	REMOVED GEOMETRY.	B	76076P	U01A133	CIRCUIT DIAGRAM, TERRASTAR	
					RELEASE NO.	DATE	
					67696A	04AUG10	
						PART NO.	
						AE08064601	
						008	

Figure 114 Intentionally Left Blank

10.9. REMOTE POWER MODULE – CAB MOUNTED, P. 9

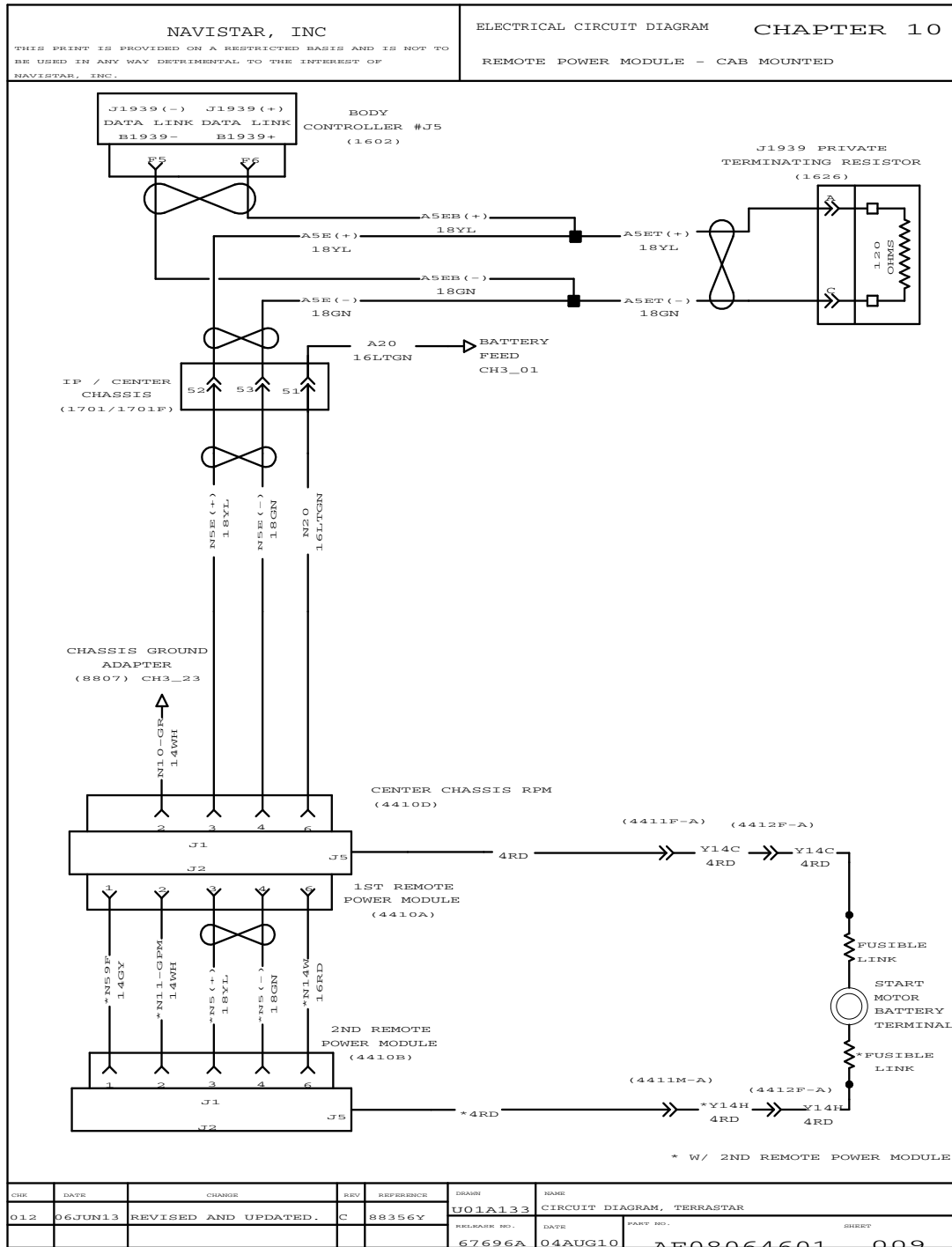

Figure 115 Remote Power Module – Cab Mounted

10.10. REMOTE POWER MODULE – CAB MOUNTED (CONT.), P. 9A

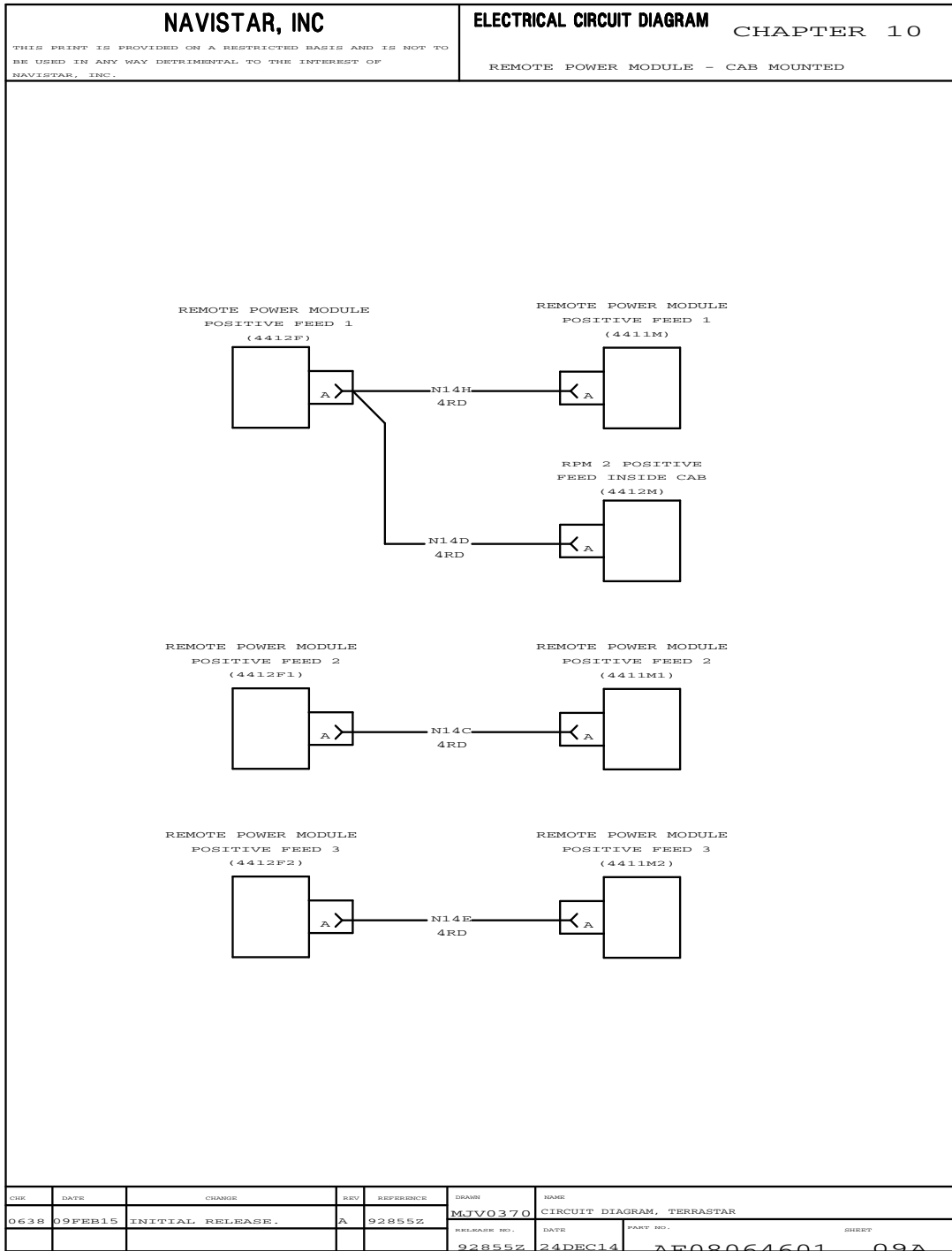

Figure 116 Remote Power Module – Cab Mounted (Cont.)

10.11. FUEL / HEATER RELAY, P. 10

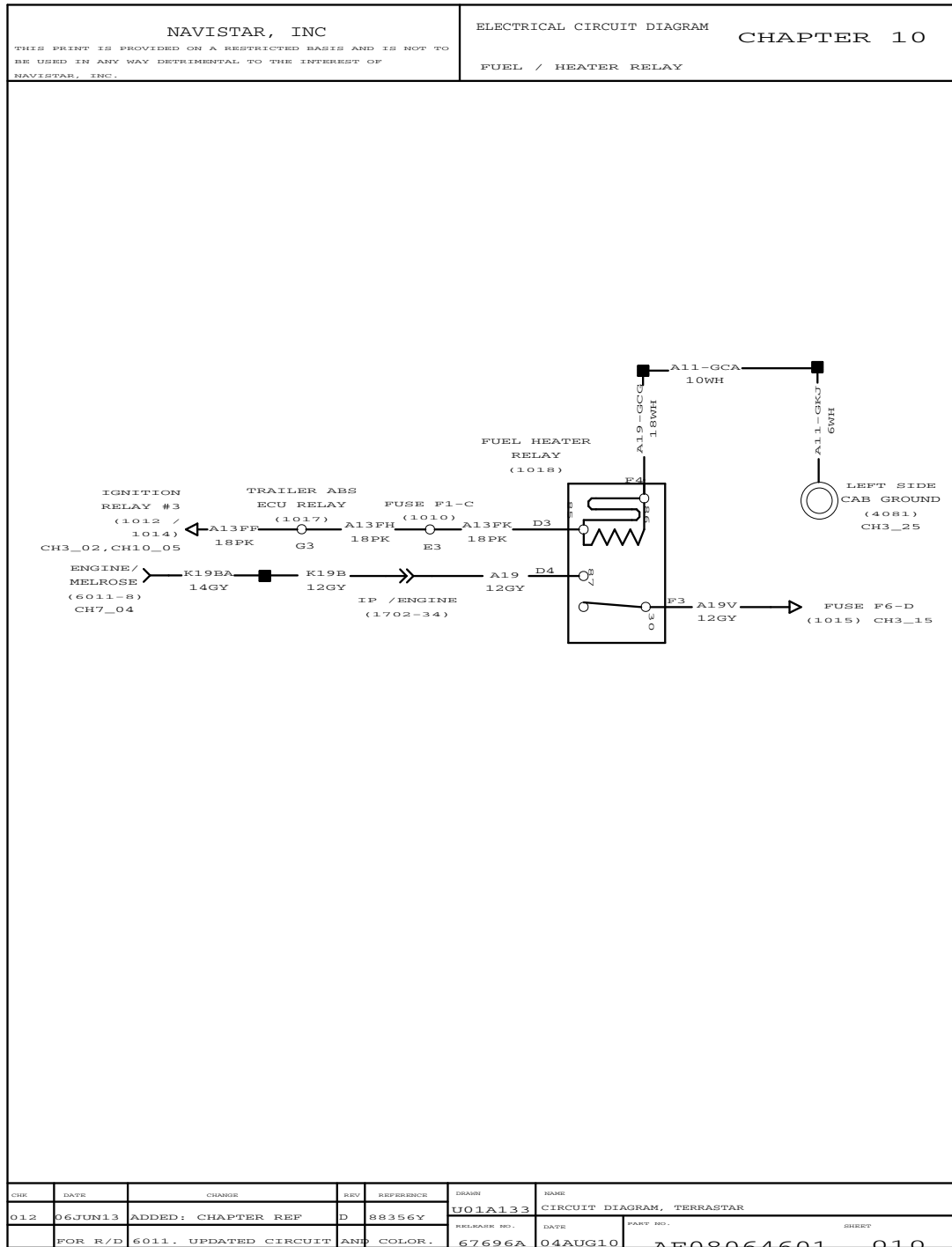

Figure 117 Fuel / Heater Relay

CHK	DATE	CHANGE	REV	REFERENCE	DRAWN	DATE	PART NO.	SHEET
012	06JUN13	ADDED: CHAPTER REF	D	88356Y	U01A133			
	FOR R/D	6011. UPDATED CIRCUIT	AND	COLOR.	67696A	04AUG10	AE08064601	010

10.12. ELECTRIC TRAILER BRAKE, P. 11

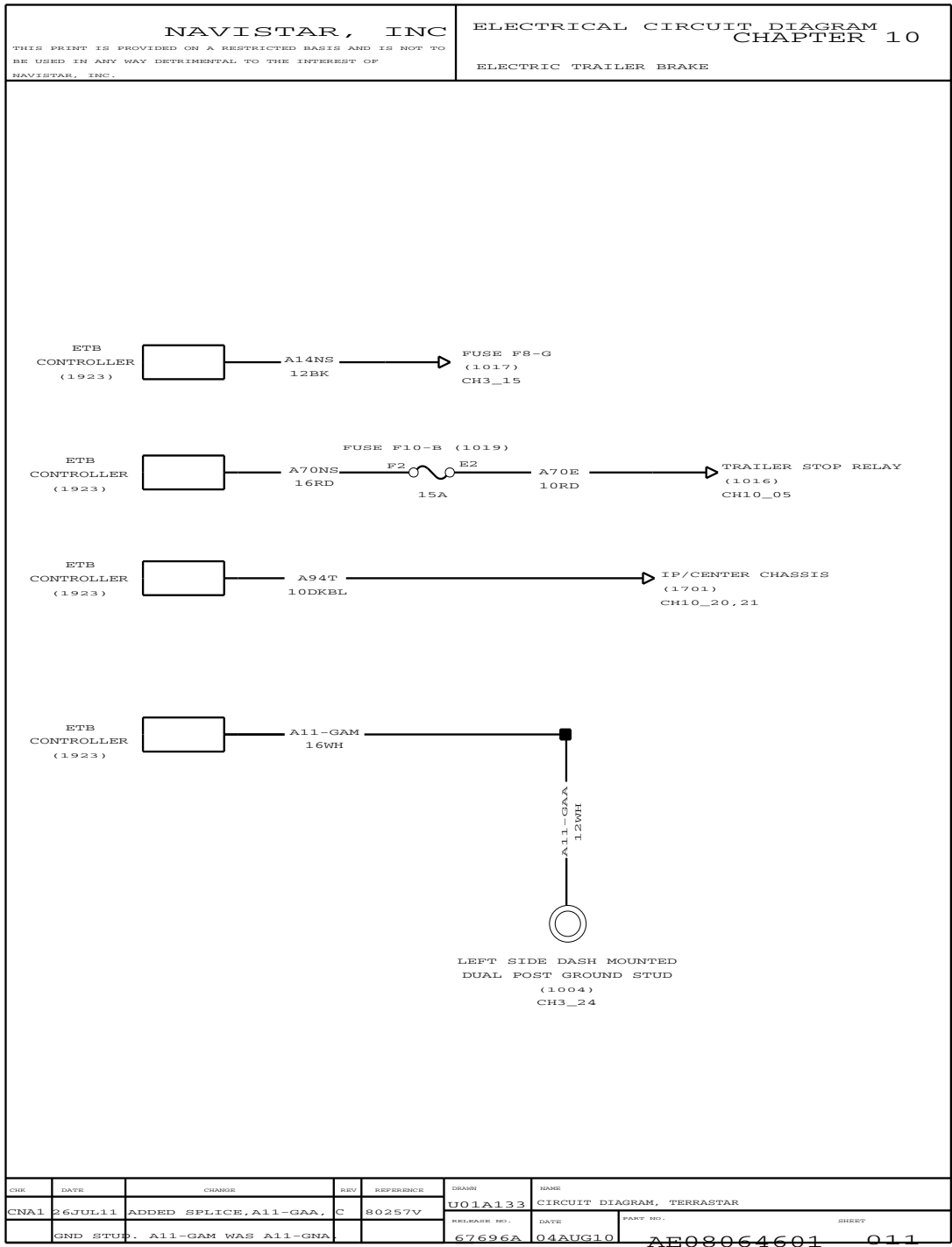

Figure 118 Electric Trailer Brake

10.13. HOUR METER – PTO, P. 12

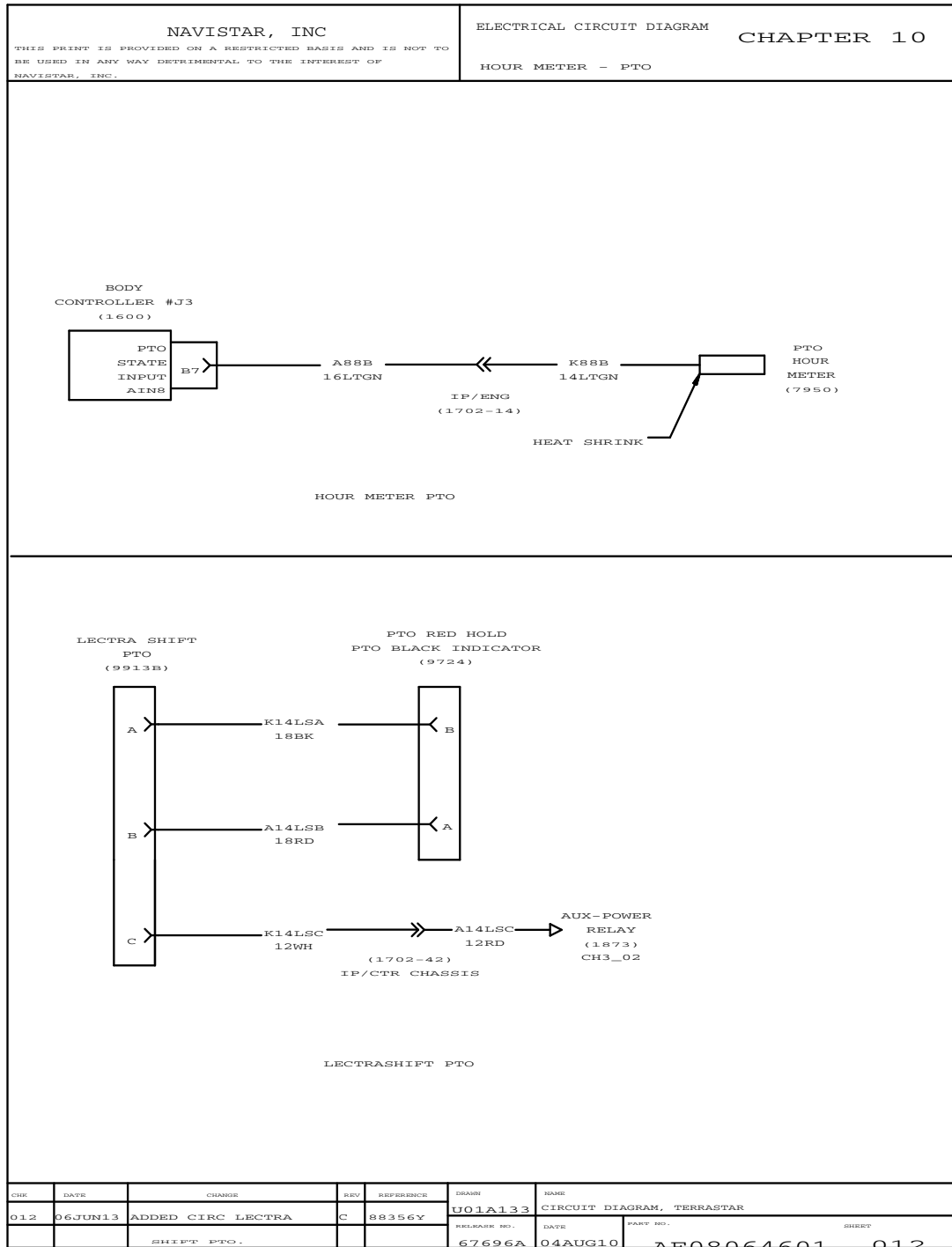

Figure 119 Hour Meter – PTO

10.14. AIR DRYER AND HEATED DRAIN VALVE, P. 13

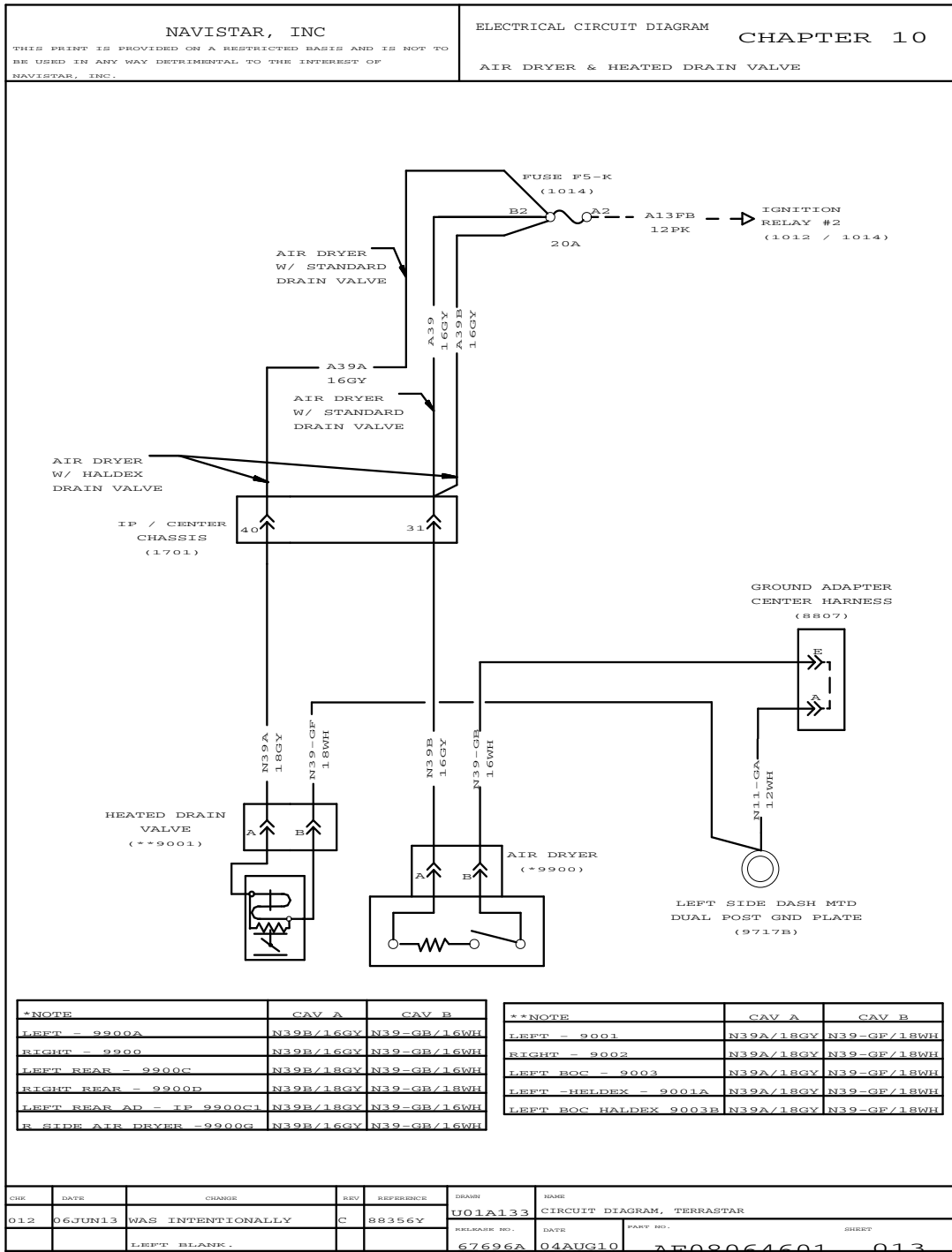

Figure 120 Air dryer and Heated Drain Valve

10.15. REMOTE START / STOP, P. 14

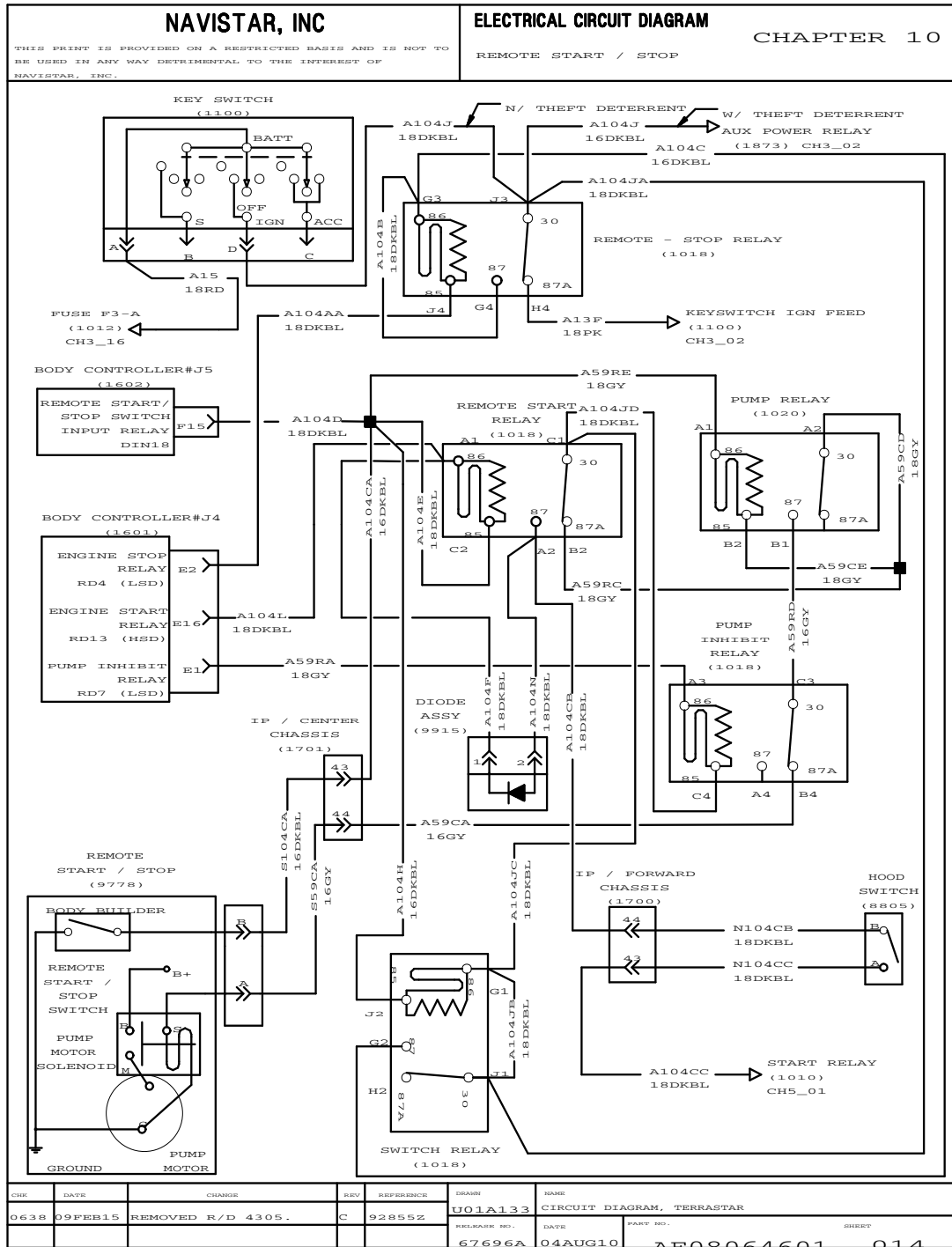

Figure 121 Remote Start / Stop

10.16. INTENTIONALLY LEFT BLANK, P. 15

<p>NAVISTAR, INC</p> <p><small>THIS PRINT IS PROVIDED ON A RESTRICTED BASIS AND IS NOT TO BE USED IN ANY WAY DETRIMENTAL TO THE INTEREST OF NAVISTAR, INC.</small></p>				<p>ELECTRICAL CIRCUIT DIAGRAM</p> <p>CHAPTER 10</p> <p>AUX & POWER SOURCE</p>			
<p>INTENTIONALLY</p> <p>LEFT BLANK</p>							
<small>CHR</small>	<small>DATE</small>	<small>CHANGE</small>	<small>REV</small>	<small>REFERENCE</small>	<small>DRAWN</small>	<small>NAME</small>	
		REMOVED GEOMETRY.	B	76076P	U01A133	CIRCUIT DIAGRAM, TERRASTAR	
					<small>RELEASE NO.</small>	<small>DATE</small>	<small>PART NO.</small>
					67696A	15OCT10	AE08064601 015

Figure 122 Intentionally Left Blank

10.17. WHEELCHAIR LIFT INTERLOCK, P. 16

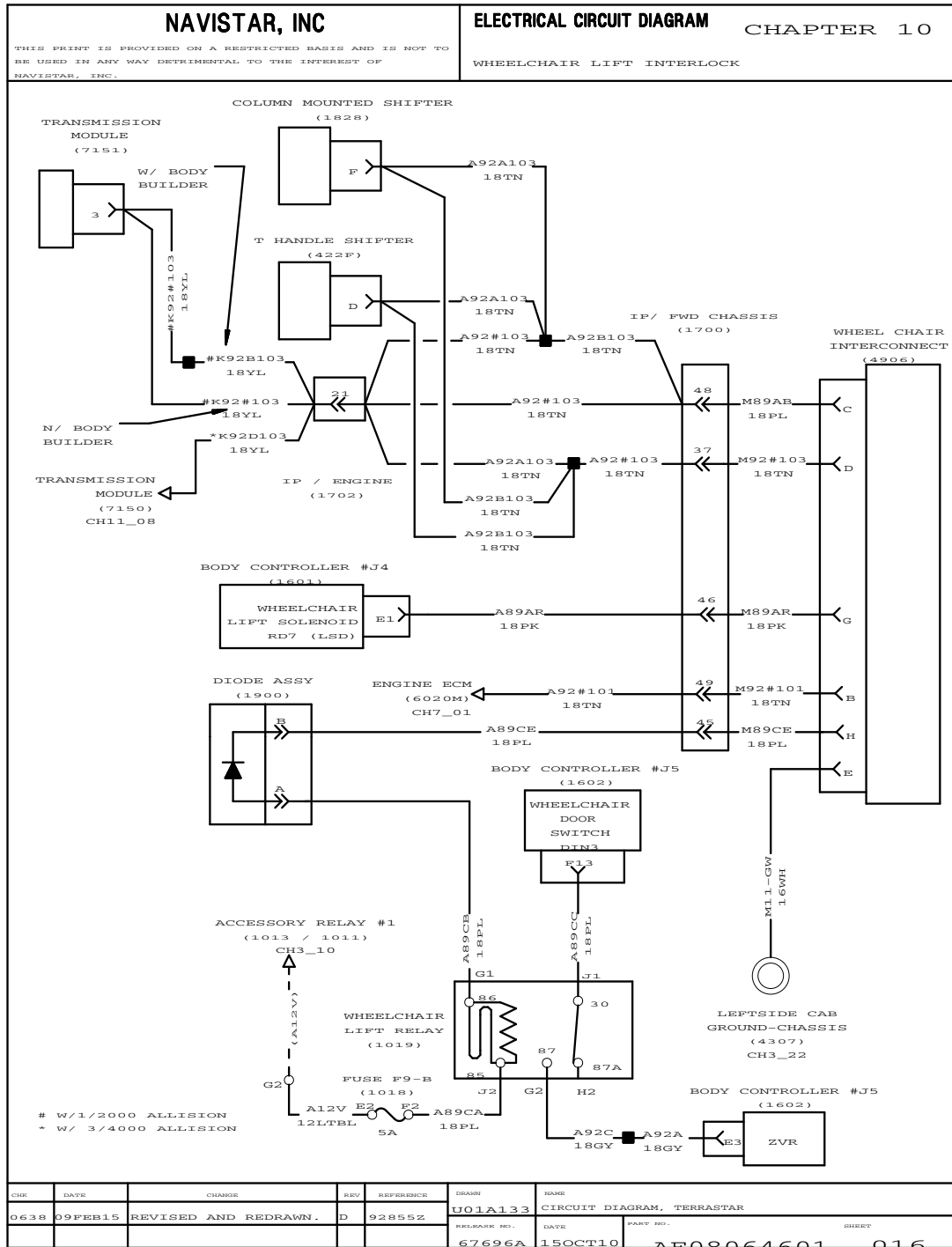

Figure 123 Wheelchair Lift Interlock

10.19. AUX INPUTS AND DRIVERS, P. 17

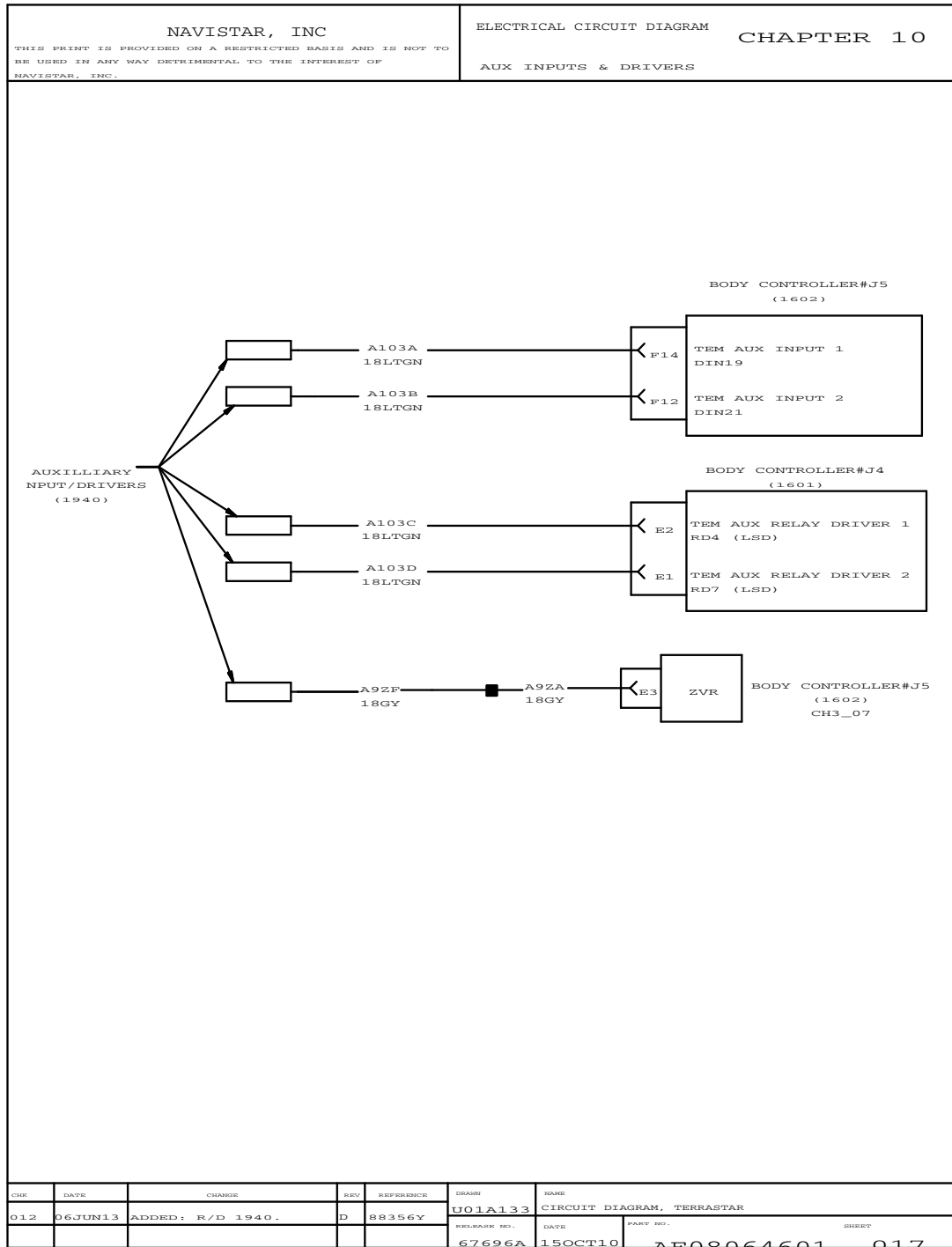

Figure 125 Aux Inputs and Drivers

10.20. AUX AND POWER SOURCE, P. 17A

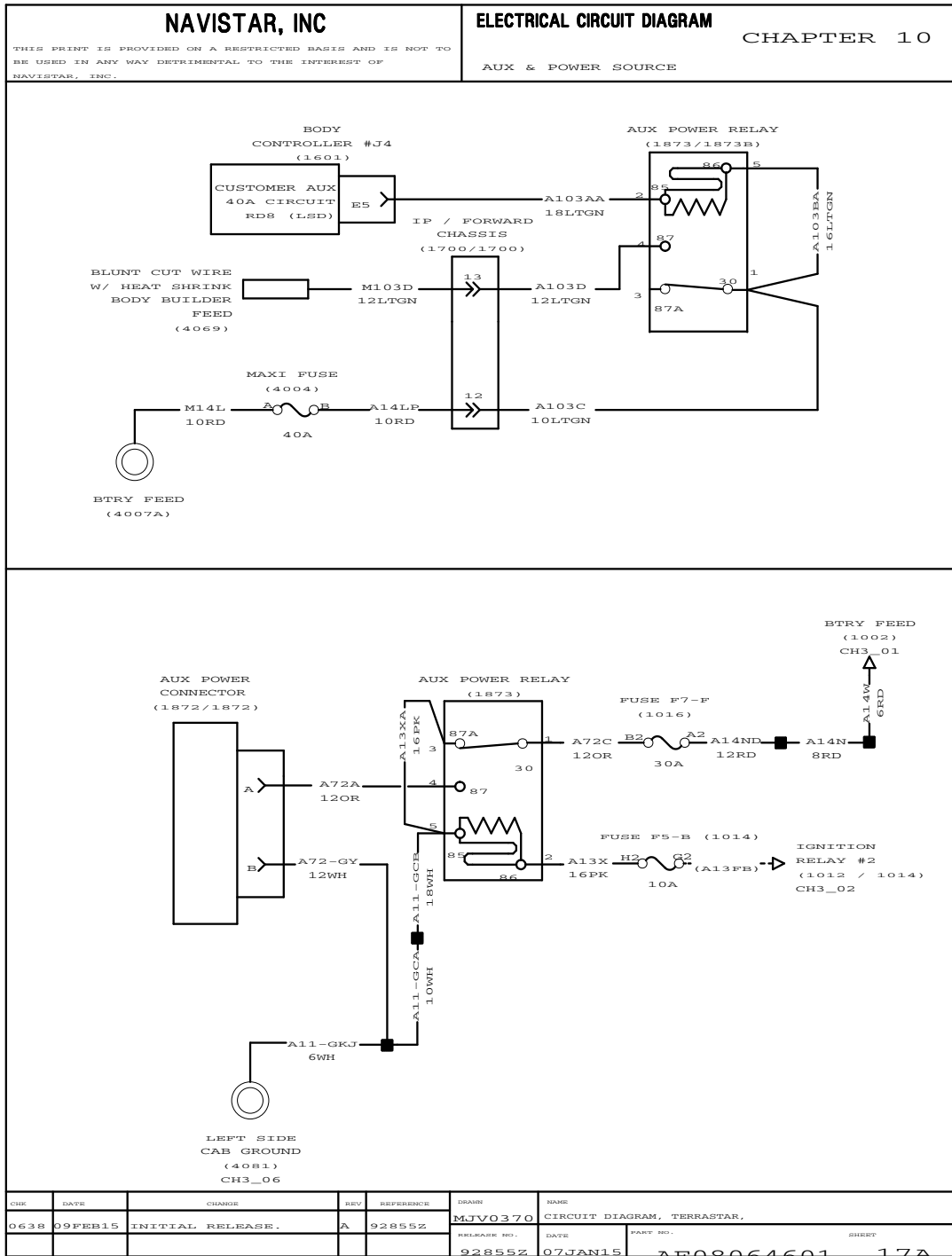

Figure 126 Aux and Power Source

10.21. TRANSFER CASE EFFECTS, P. 18

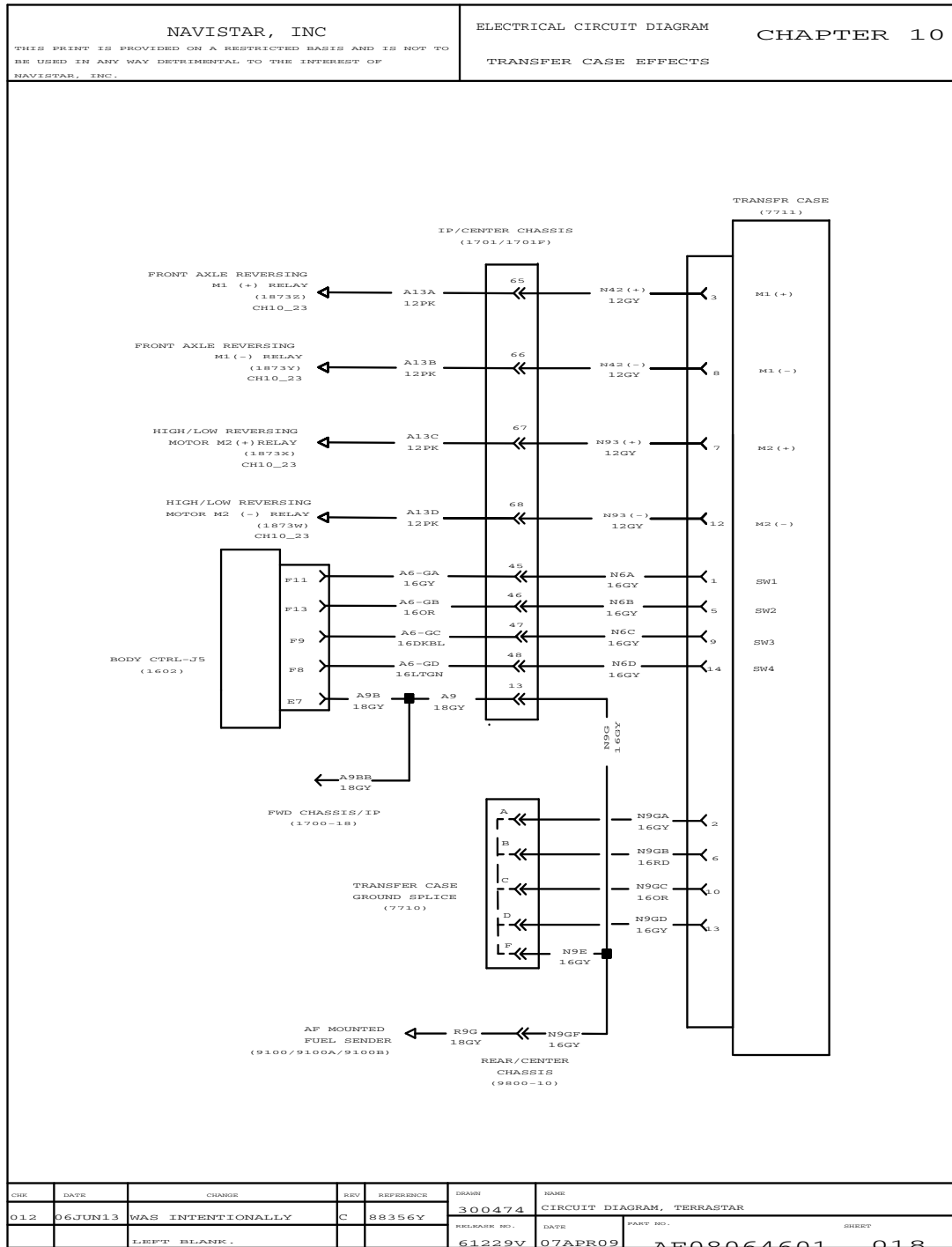

Figure 127 Transfer Case Effects

10.22. FUEL TRANSFER PUMP, P. 19

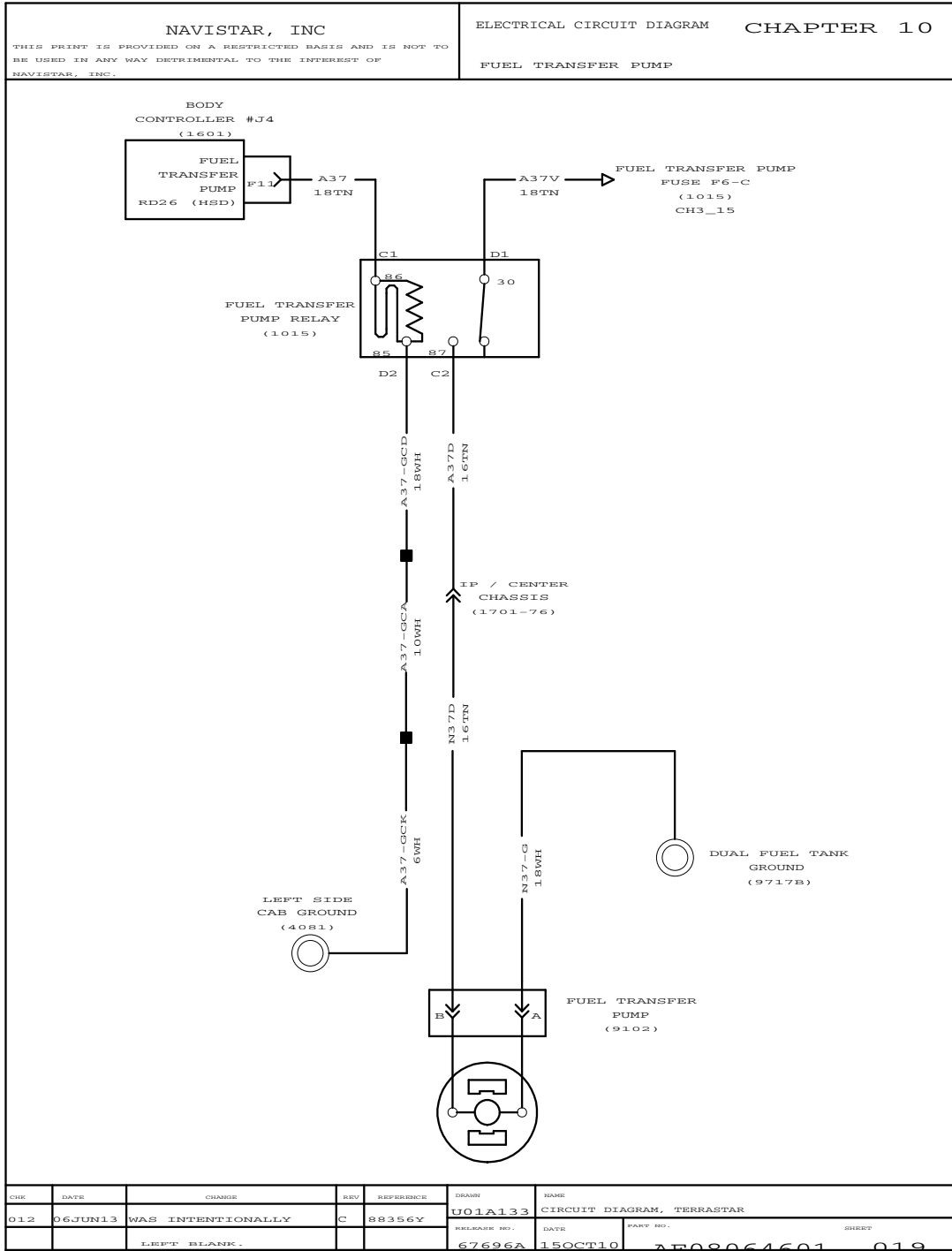

Figure 128 Fuel Transfer Pump

10.23. TRAILER SOCKET – EOF, P. 20

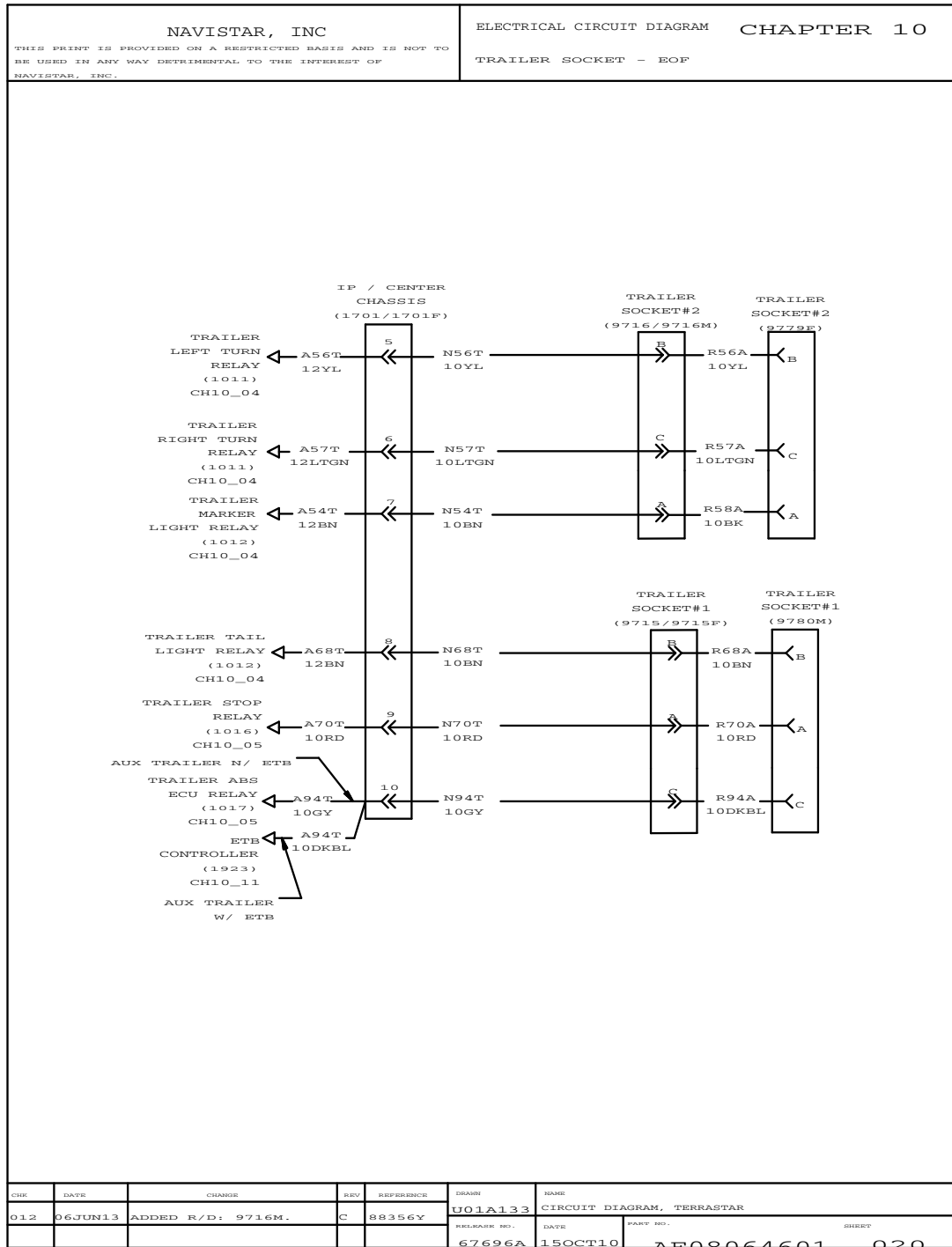

Figure 129 Trailer Socket – EOF

10.24. BODY BUILDER & TRAILER SOCKET – BOC & EOF, P. 21

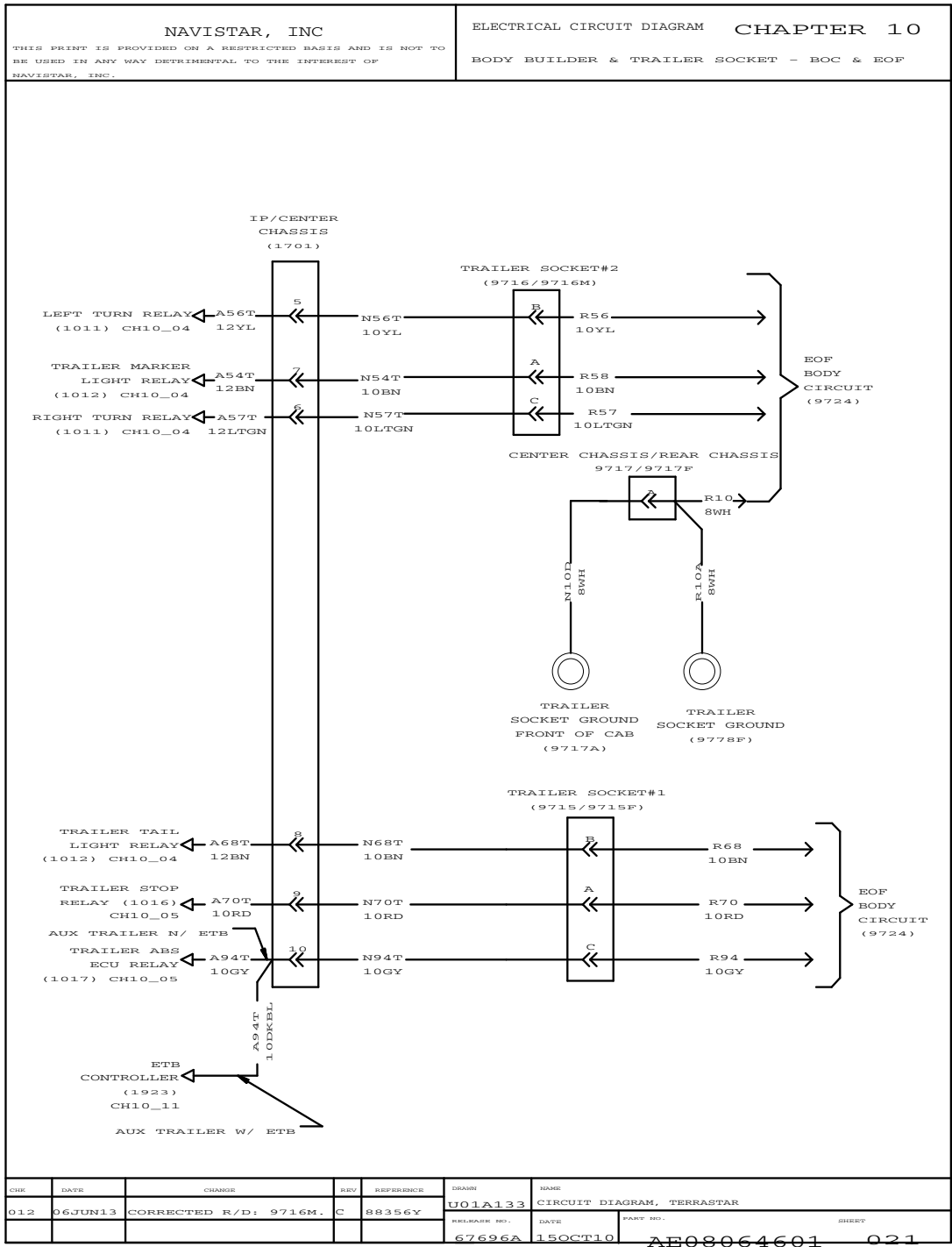

Figure 130 Body Builder & Trailer Socket – BOC & EOF

10.25. AUX TRAILER CIRCUIT, P. 22

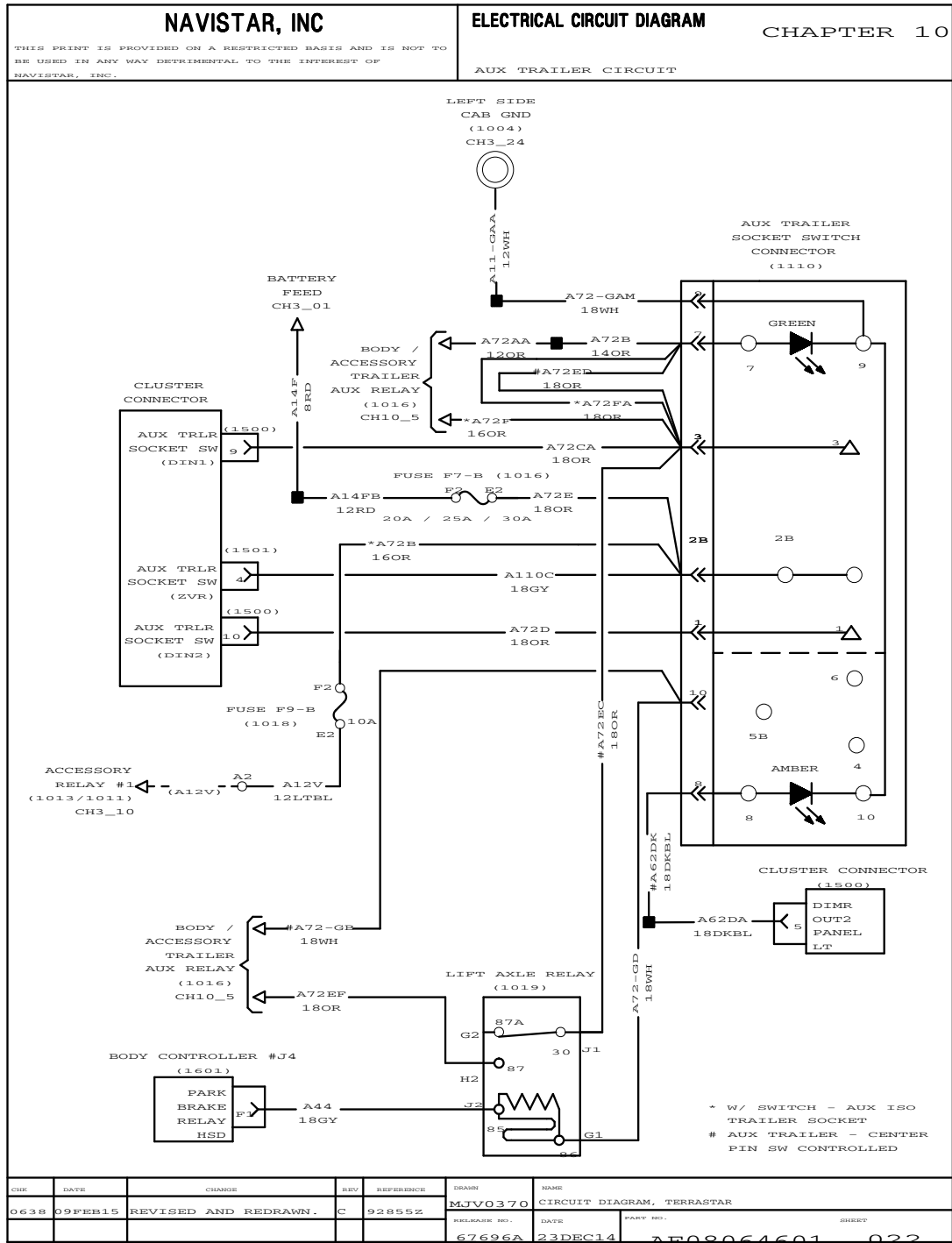

Figure 131 Aux Trailer Circuit

10.26. TRANSFER CASE EFFECTS WITH CONTROLS FOR ONE LIFT AXLE, P. 23

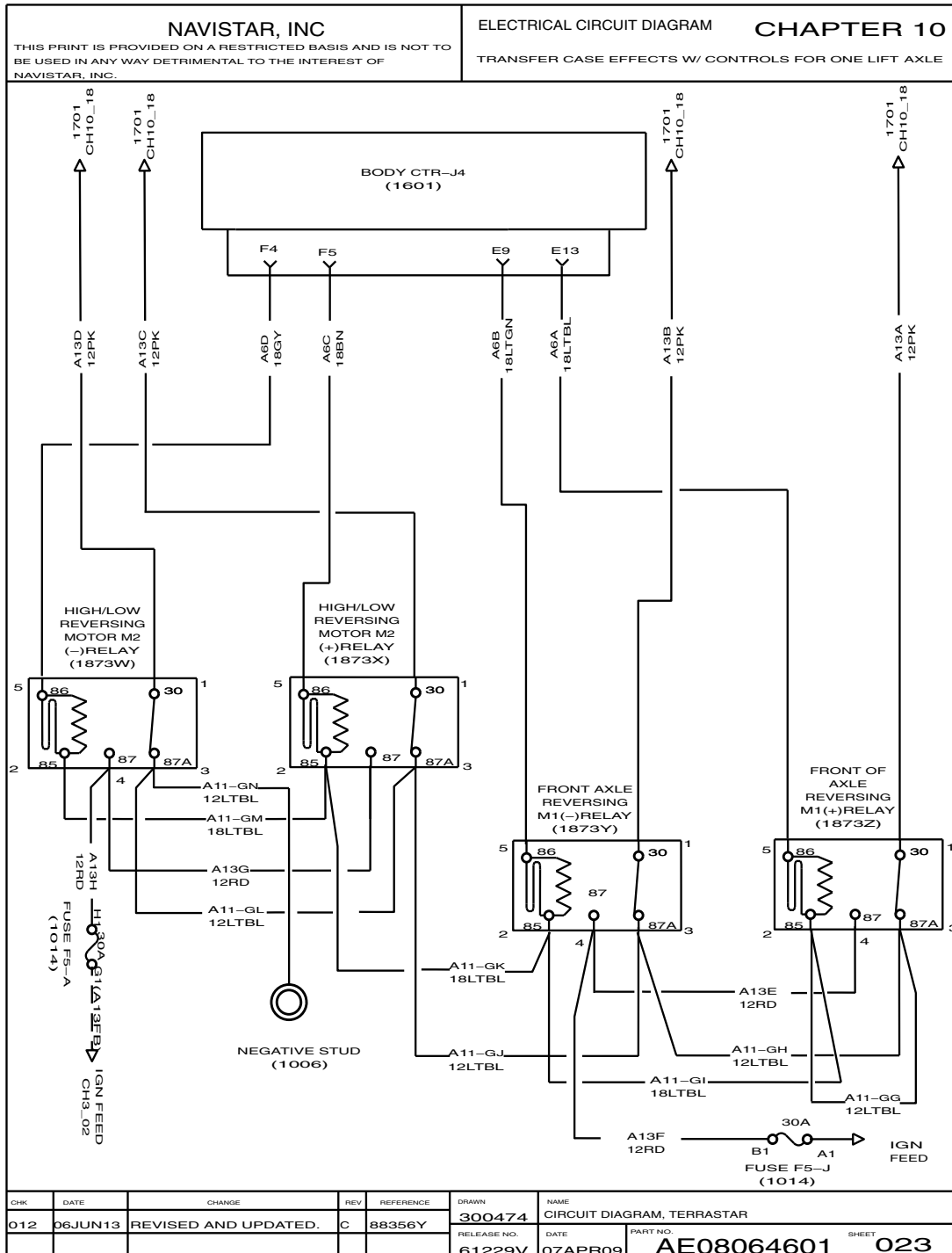

Figure 132 Transfer Case Effects with Controls for One Lift Axle

10.27. INTENTIONALLY LEFT BLANK, P. 24

<p>NAVISTAR, INC</p> <p><small>THIS PRINT IS PROVIDED ON A RESTRICTED BASIS AND IS NOT TO BE USED IN ANY WAY DETRIMENTAL TO THE INTEREST OF NAVISTAR, INC.</small></p>				<p>ELECTRICAL CIRCUIT DIAGRAM CHAPTER 10</p> <p>LIFT AXLE (NON - STEERABLE)</p>			
<p style="font-size: 2em; letter-spacing: 0.5em;">INTENTIONALLY LEFT BLANK</p>							
CHR	DATE	CHANGE	REV	REFERENCE	DRAWN	NAME	
CNA1	25MAR11	REMOVED GEOMETRY.	B	76076P	U01A133	CIRCUIT DIAGRAM, TERRASTAR	
					RELEASE NO.	DATE	
					67696A	15OCT10	
						PART NO. SHEET	
						AE08064601 024	

Figure 133 Intentionally Left Blank

10.28. INTENTIONALLY LEFT BLANK, P. 25

NAVISTAR, INC <small>THIS PRINT IS PROVIDED ON A RESTRICTED BASIS AND IS NOT TO BE USED IN ANY WAY DETRIMENTAL TO THE INTEREST OF NAVISTAR, INC.</small>				ELECTRICAL CIRCUIT DIAGRAM CHAPTER 10 LIFT AXLE (STEERABLE)			
<h1 style="margin: 0;">INTENTIONALLY LEFT BLANK</h1>							
CHR	DATE	CHANGE	REV	REFERENCE	DRAWN	NAME	
CNA1	25MAR11	REMOVED GEOMETRY.	B	76076P	U01A133	CIRCUIT DIAGRAM, TERRASTAR	
					RELEASE NO.	DATE	
					67696A	15OCT10	
					PART NO.	SHEET	
					AE08064601	025	

Figure 134 Intentionally Left Blank

10.29. INTENTIONALLY LEFT BLANK, P. 26

NAVISTAR, INC <small>THIS PRINT IS PROVIDED ON A RESTRICTED BASIS AND IS NOT TO BE USED IN ANY WAY DETRIMENTAL TO THE INTEREST OF NAVISTAR, INC.</small>				ELECTRICAL CIRCUIT DIAGRAM CHAPTER 10 POWER SOURCE, CUSTOMER INSTALLED LIFT GATE			
<h1 style="margin: 0;">INTENTIONALLY LEFT BLANK</h1>							
CHK	DATE	CHANGE	REV	REFERENCE	DRAWN	NAME	
	CNA1 25MAR11	REMOVED GEOMETRY.	B	76076P	U01A133	CIRCUIT DIAGRAM, TERRASTAR	
					RELEASE NO.	DATE	PART NO.
					67696A	15OCT10	AE08064601 026

Figure 135 Intentionally Left Blank

10.30. AIR HORN, P. 27

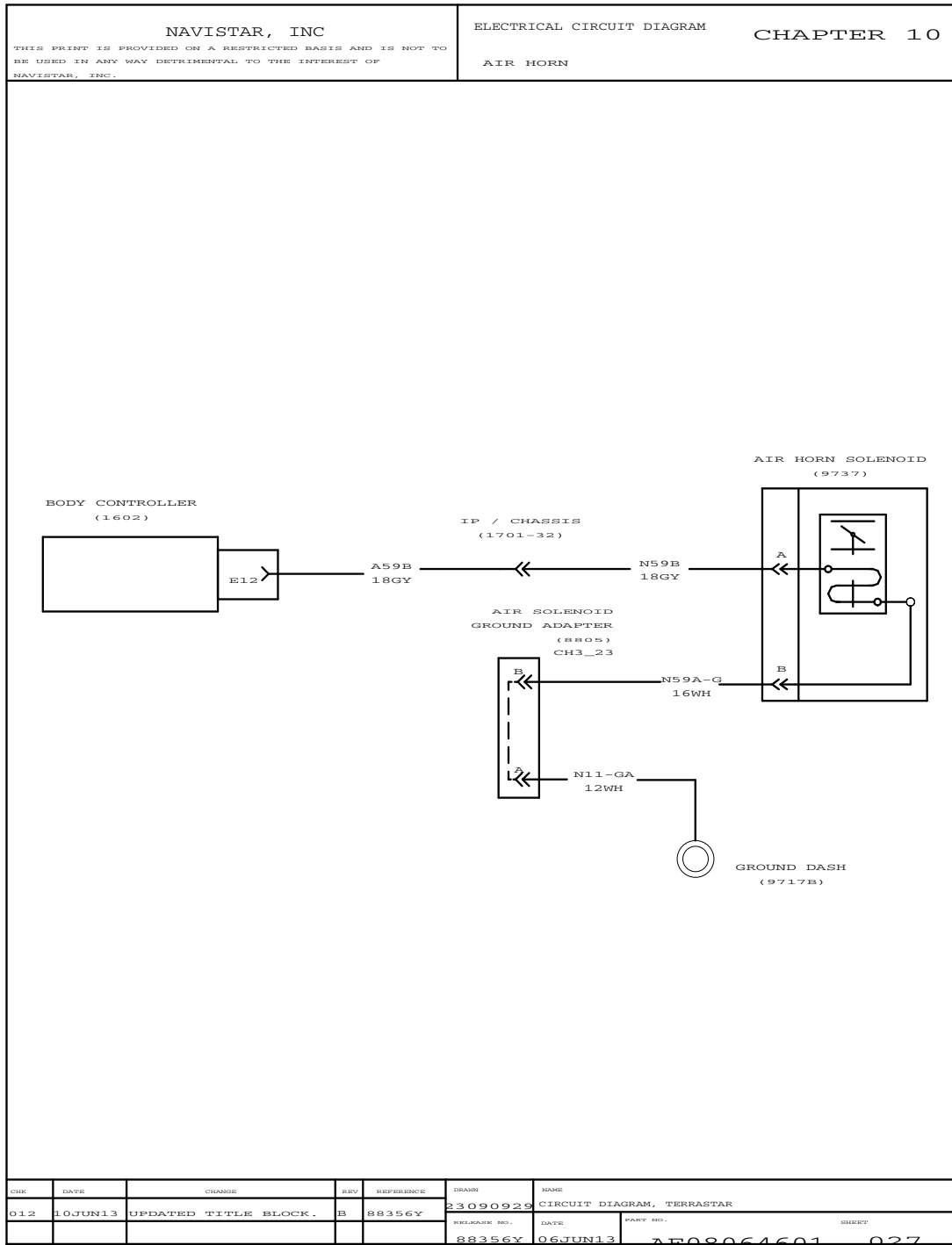

Figure 136 Air Horn

10.31. AIR SOLENOID 4-PACK, P. 28

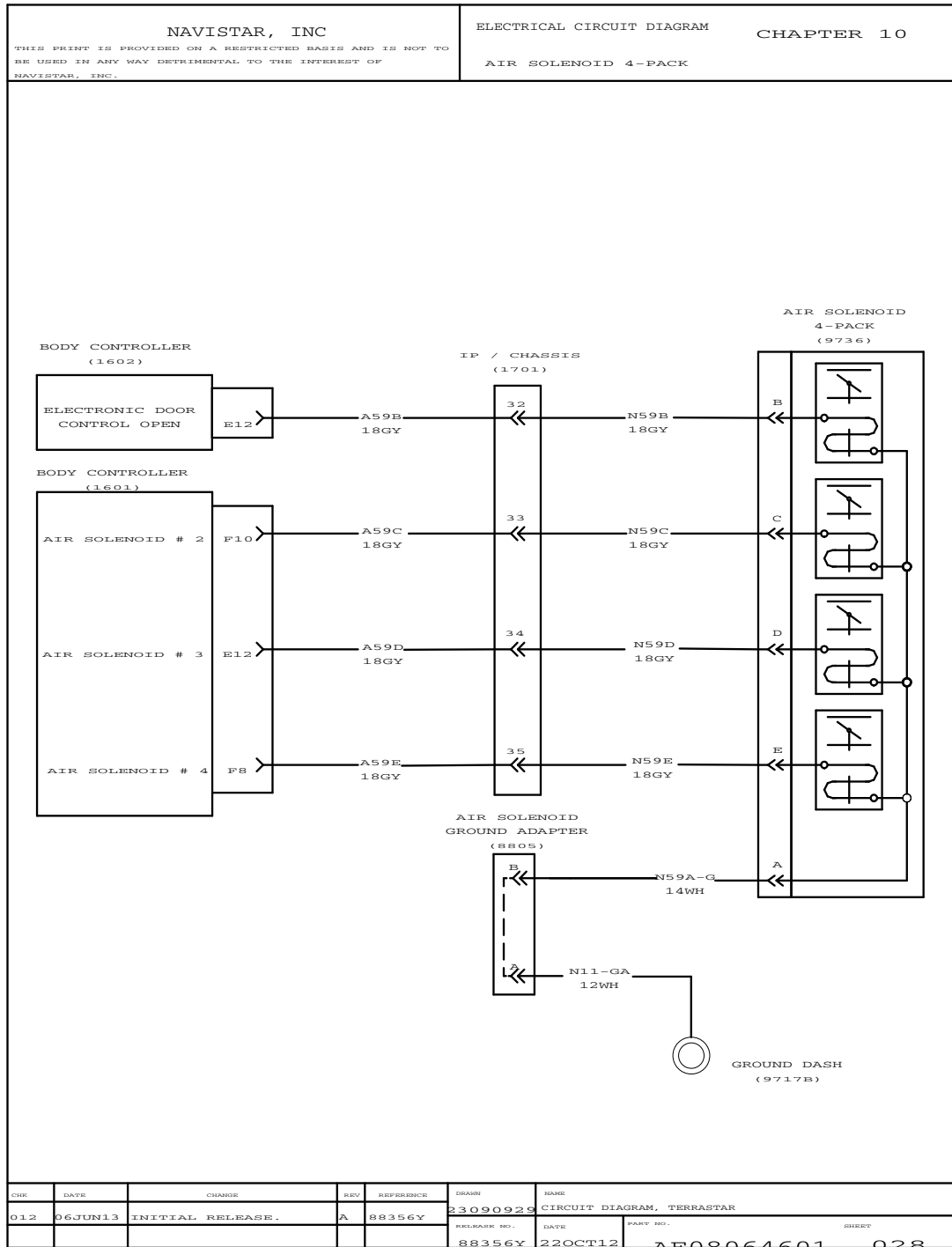

Figure 137 Air Solenoid 4-Pack

10.32. AIR SOLENOID 8-PACK, P. 29

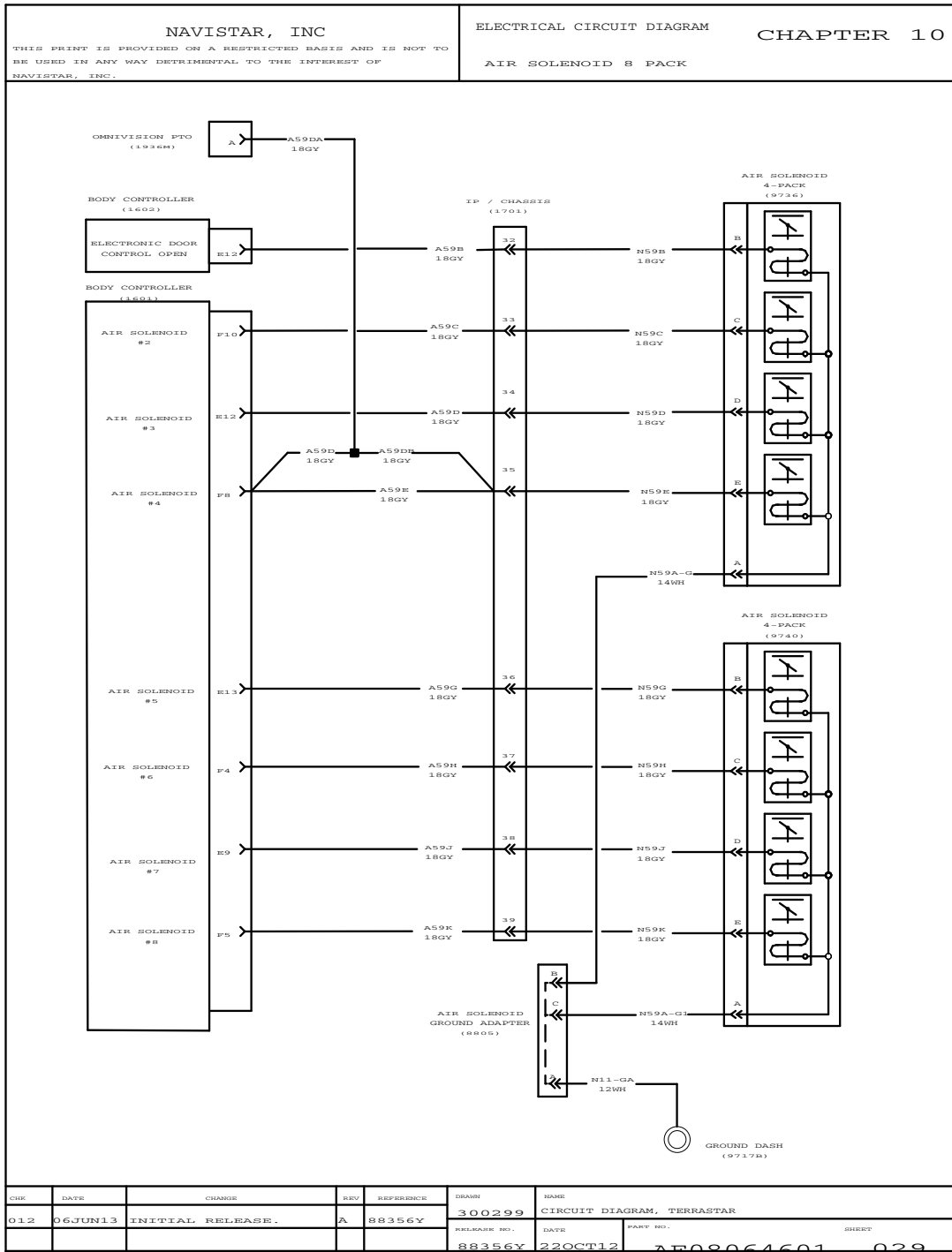

Figure 138 Air Solenoid 8-Pack

TRANSMISSION (CHAPTER 11)

11.1. ALLISON GEN 4 1/2000 TRANSMISSION, P. 1

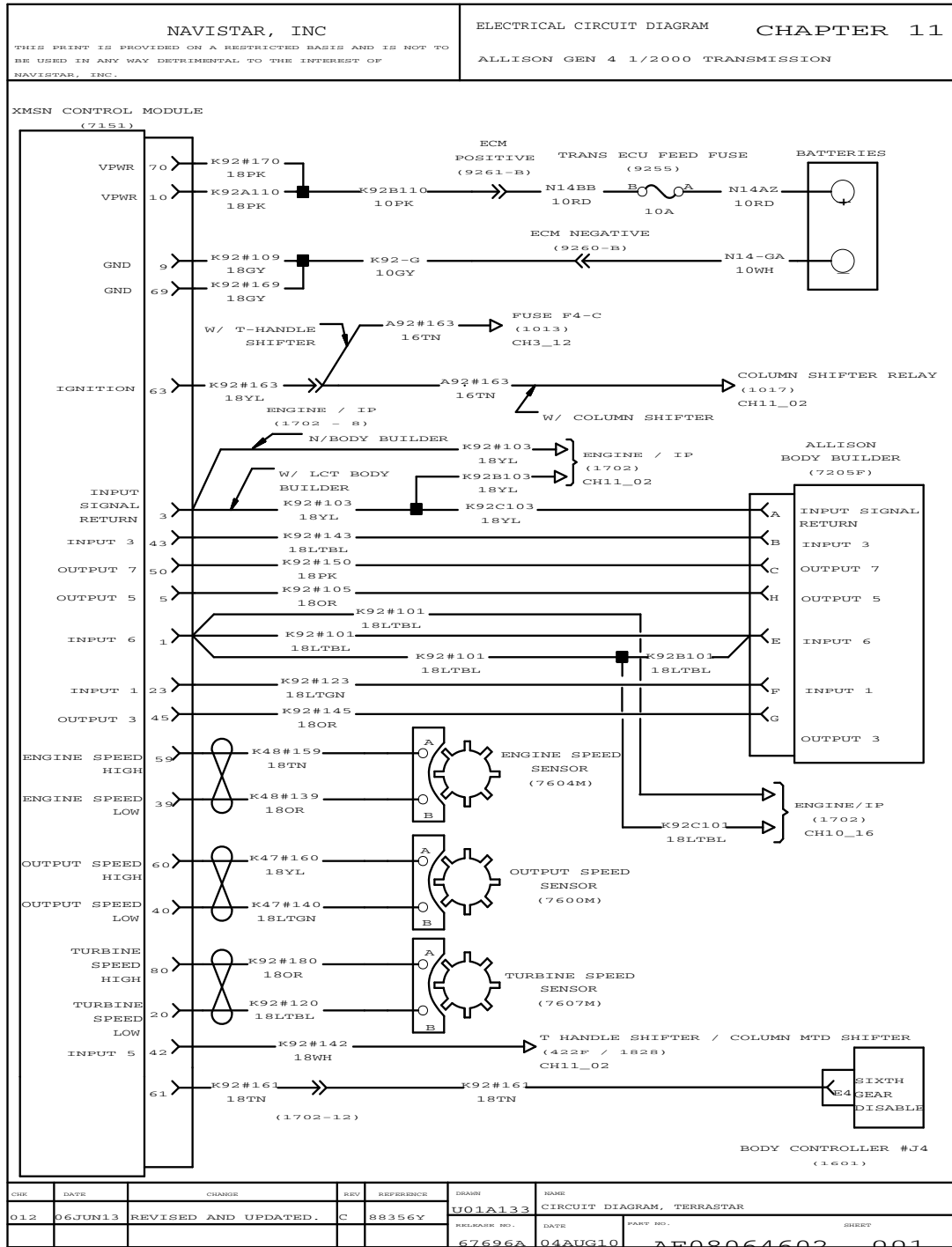

Figure 139 Allison Gen 4 1/2000 Transmission

11.2. ALLISON GEN 4 1/2000 TRANSMISSION (CONT.), P. 2

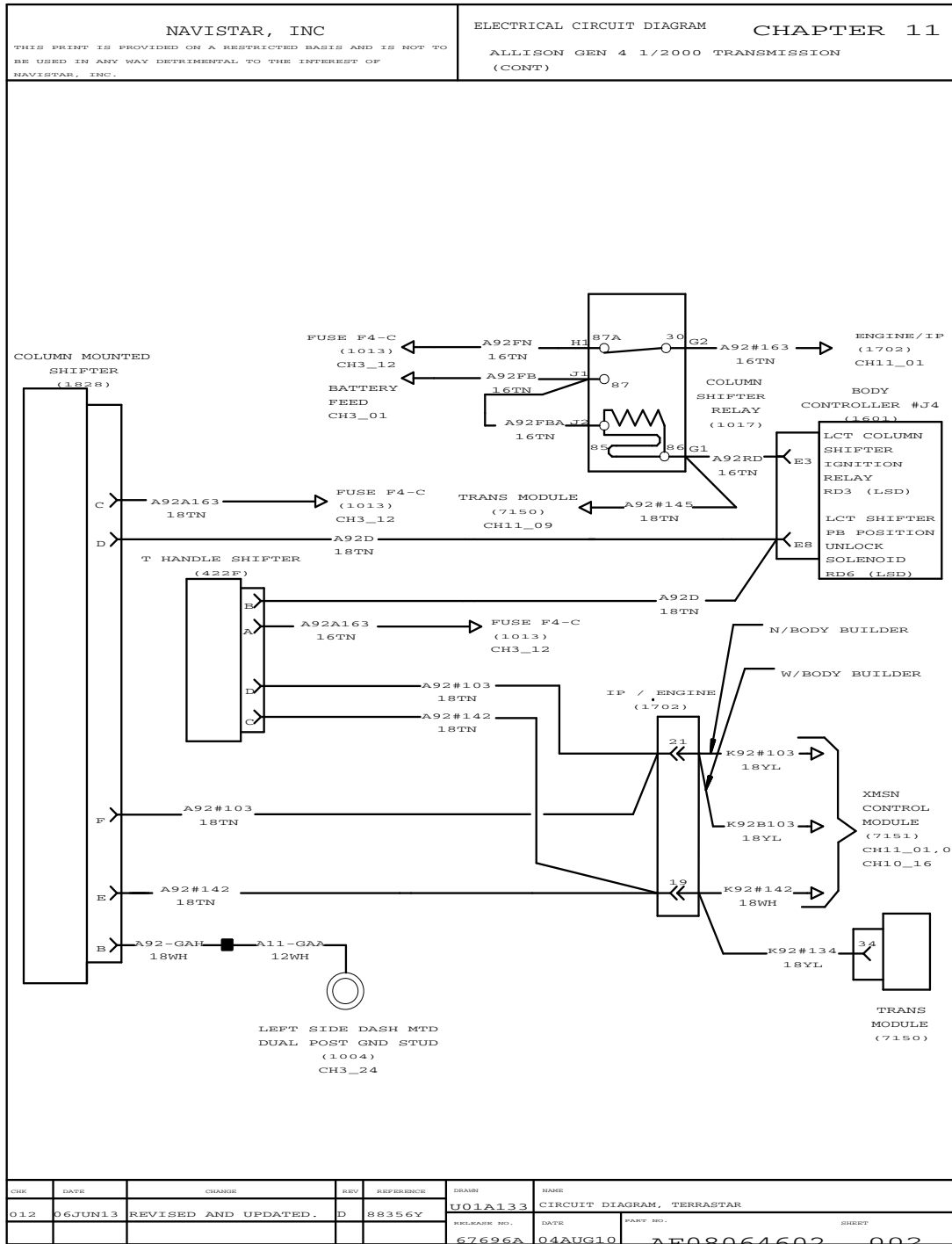

Figure 140 Allison Gen 4 1/2000 Transmission (Cont.)

11.3. ALLISON GEN 1/2000 TRANSMISSION, P. 3

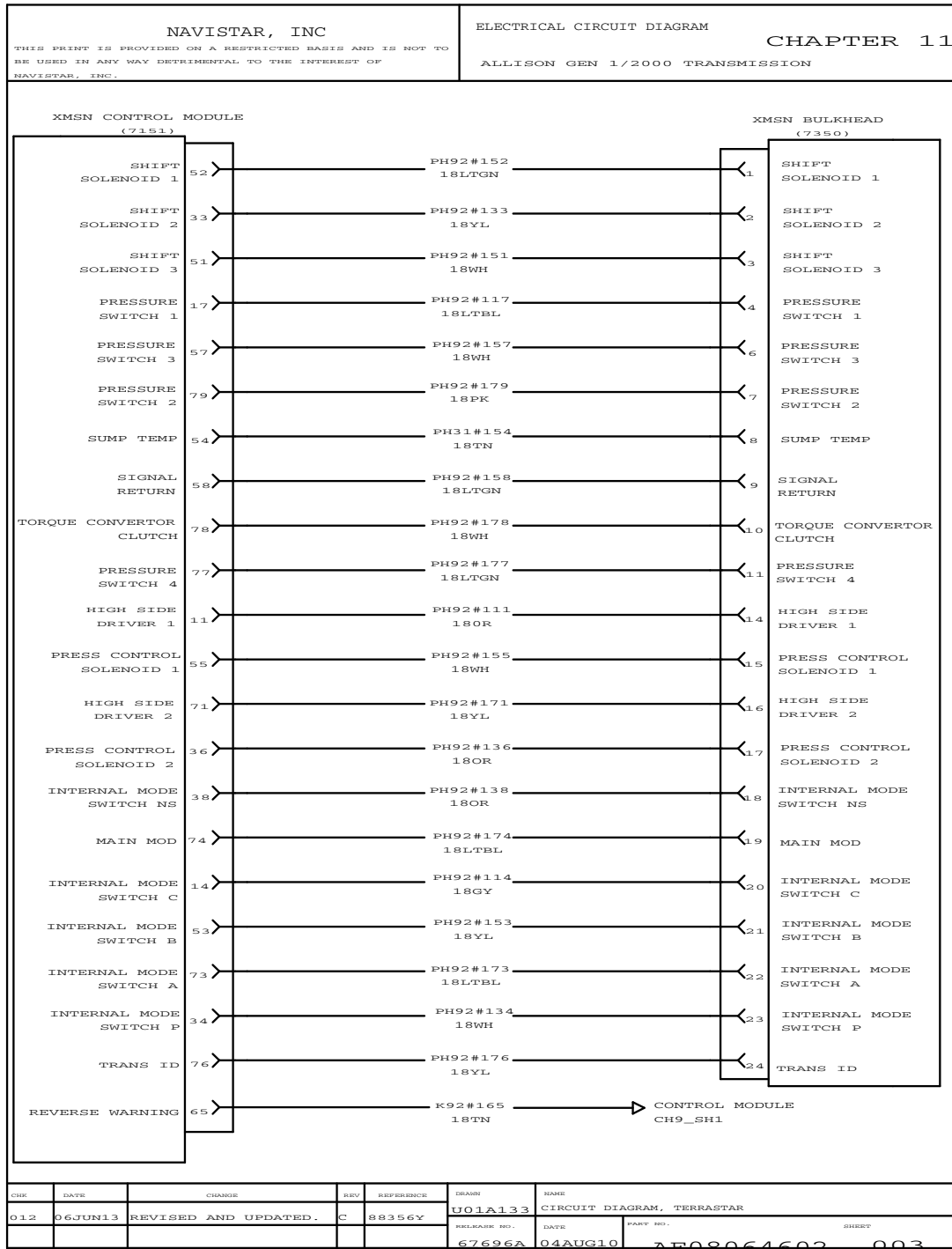

Figure 141 Allison Gen 1/2000 Transmission

11.4. TRANSMISSION ALLISON MD (WTEC), P. 4

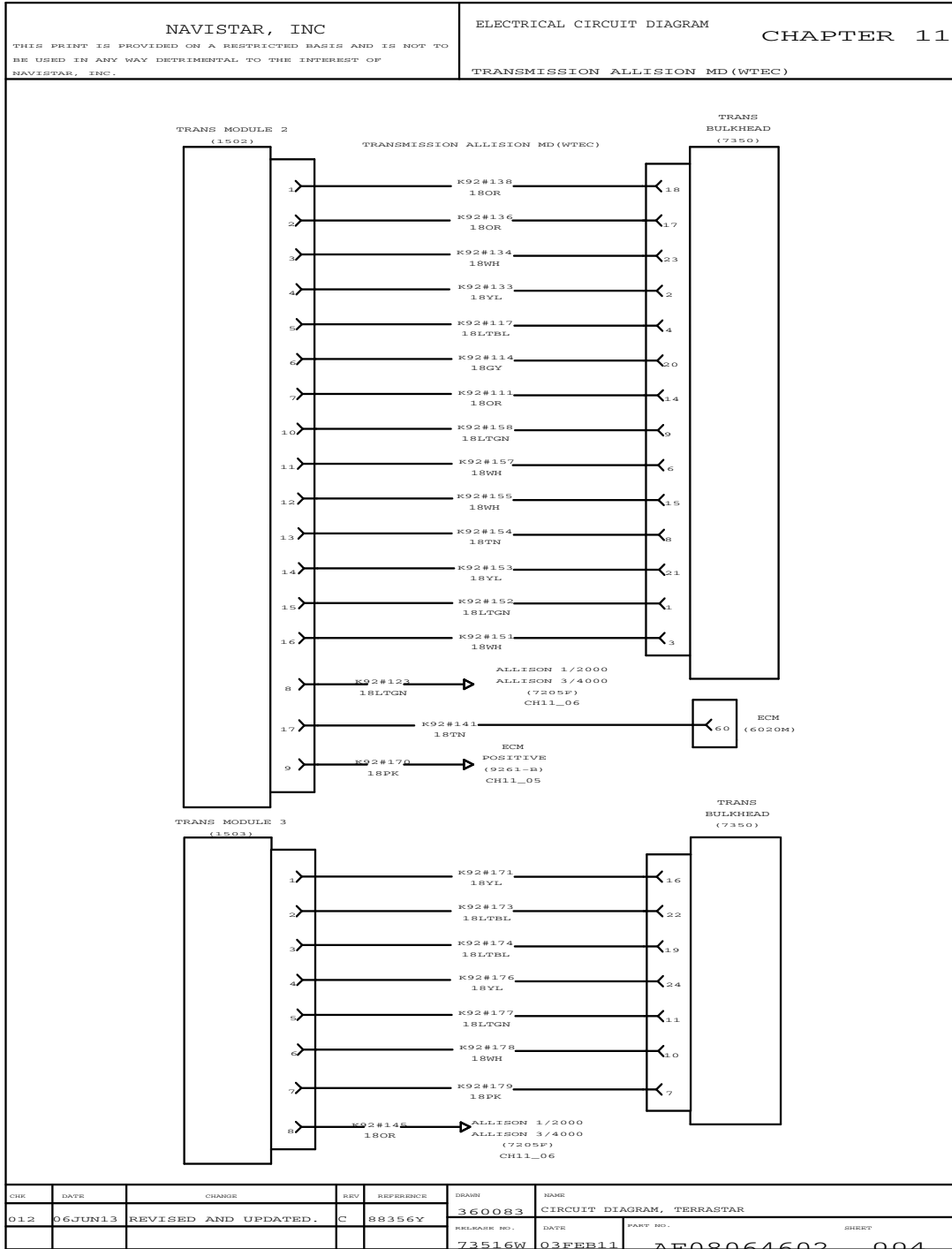

Figure 142 Transmission Allison MD (WTEC)

11.5. ALLISON TRANSMISSION 1/2000 WITH IN-CAB TCM, P. 5

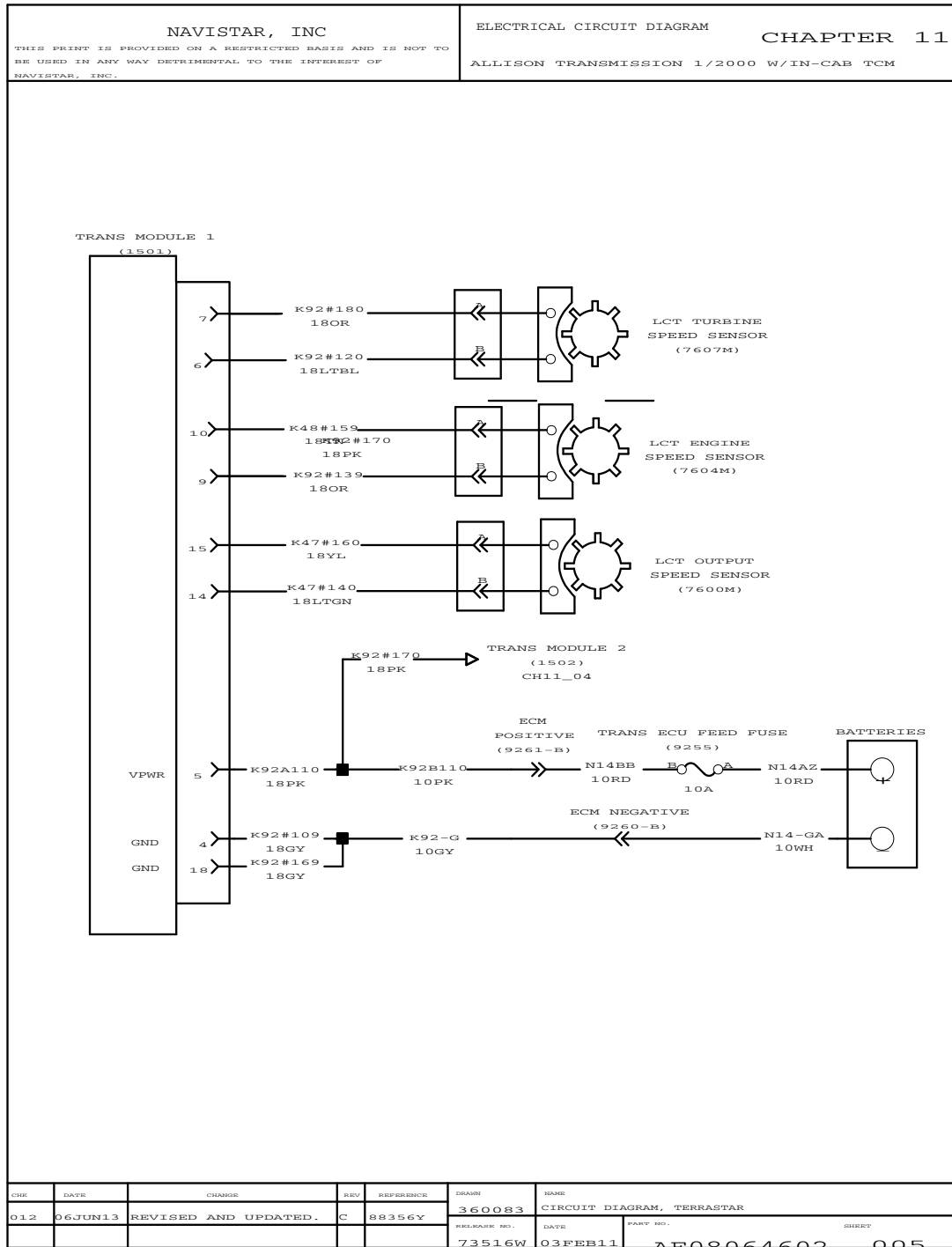

Figure 143 Allison Transmission 1/2000 with In-Cab TCM

11.6. SHIFTER INTERLOCK EFFECTS, P. 6

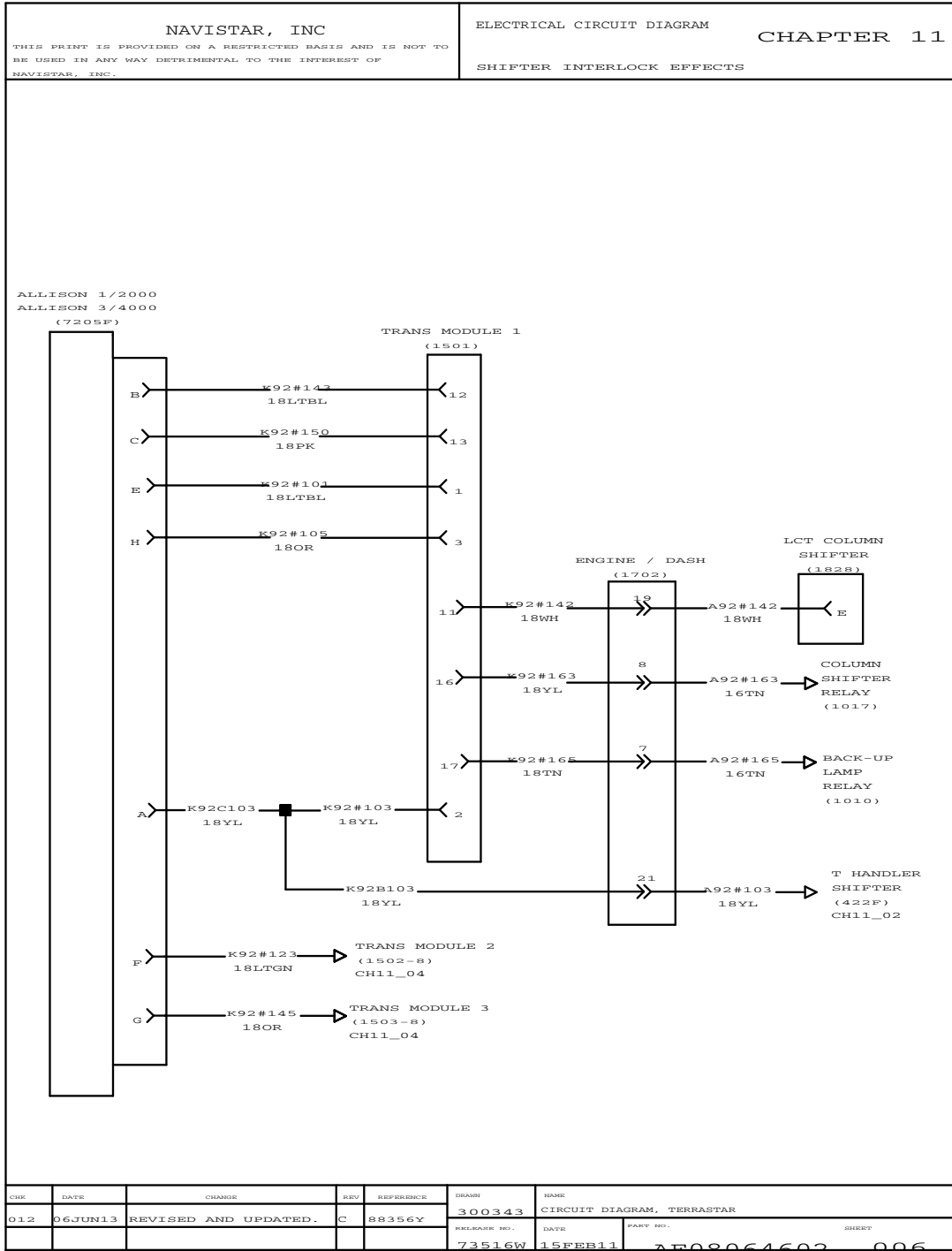

Figure 144 Shifter Interlock Effects

11.7. SHIFTER INTERLOCK EFFECT (CONT.), P. 7

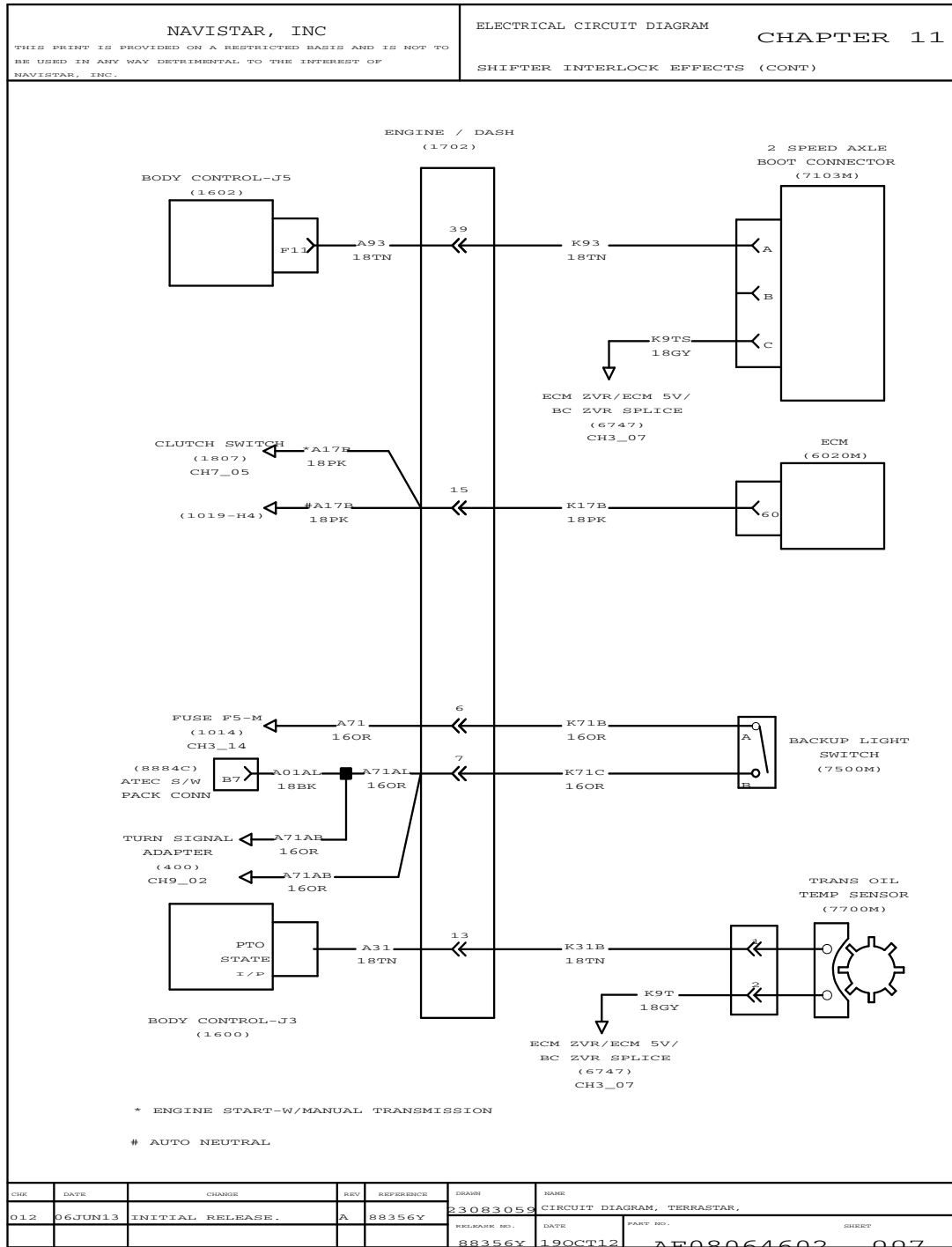

Figure 145 Shifter Interlock Effect (Cont.)

11.8. ALLISON WTEC TRANSMISSION GEN 8, P. 8

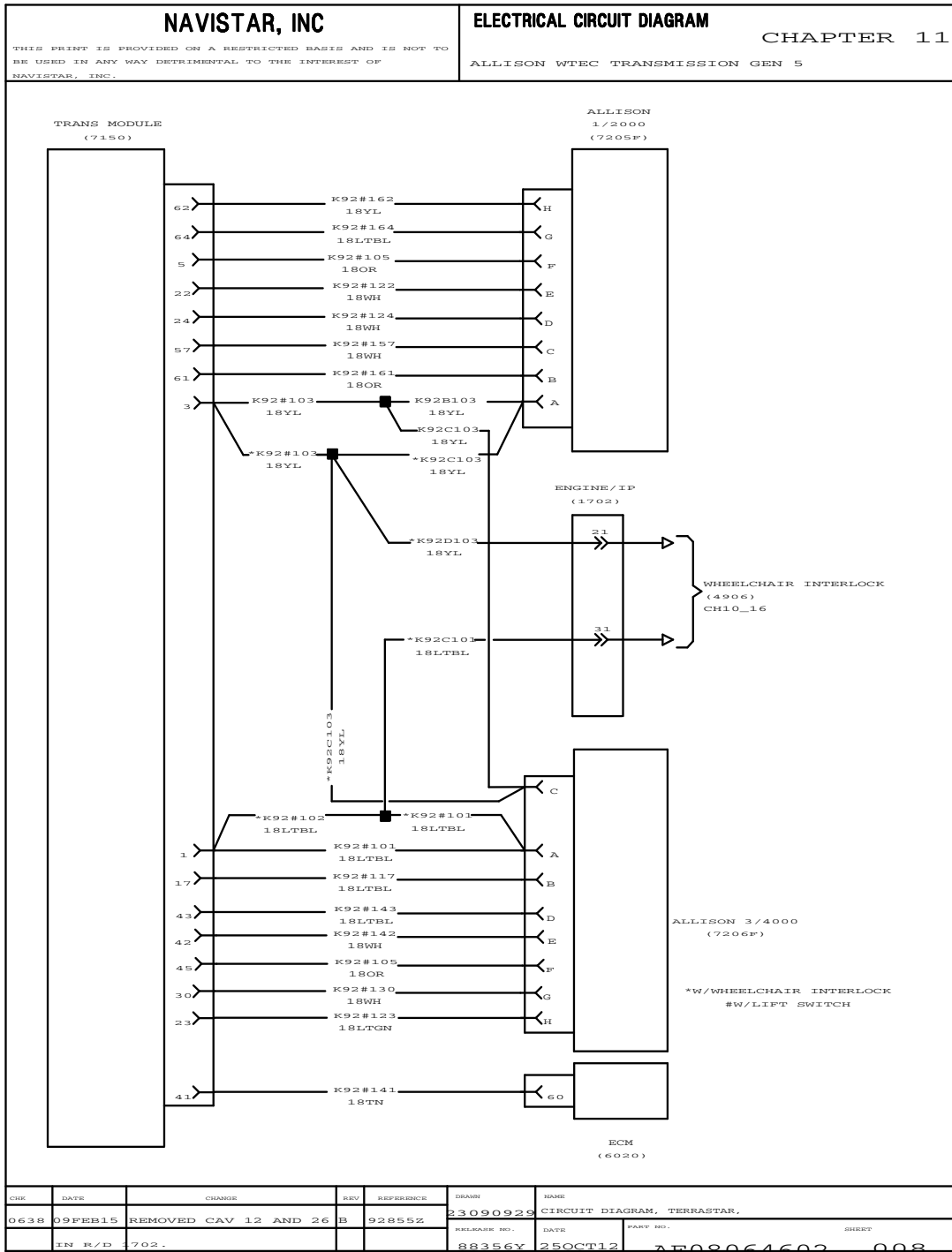

Figure 146 Allison WTEC Transmission Gen 8

11.9. WTEC GEN 4 TRANSMISSION, P. 9

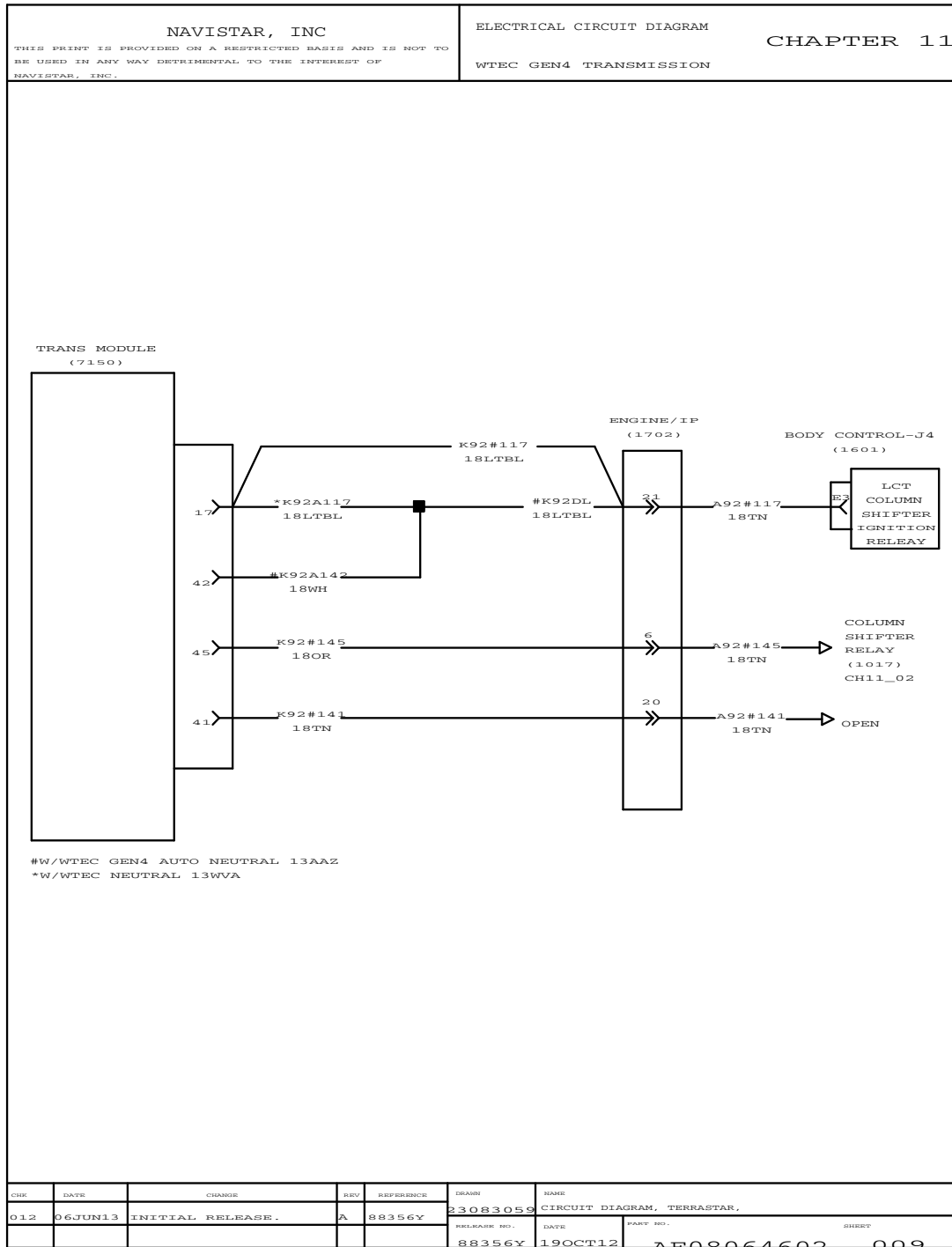

Figure 147 WTEC GEN 4 Transmission

11.10. WTEC GEN 4 TRANSMISSION (CONT.), P. 10

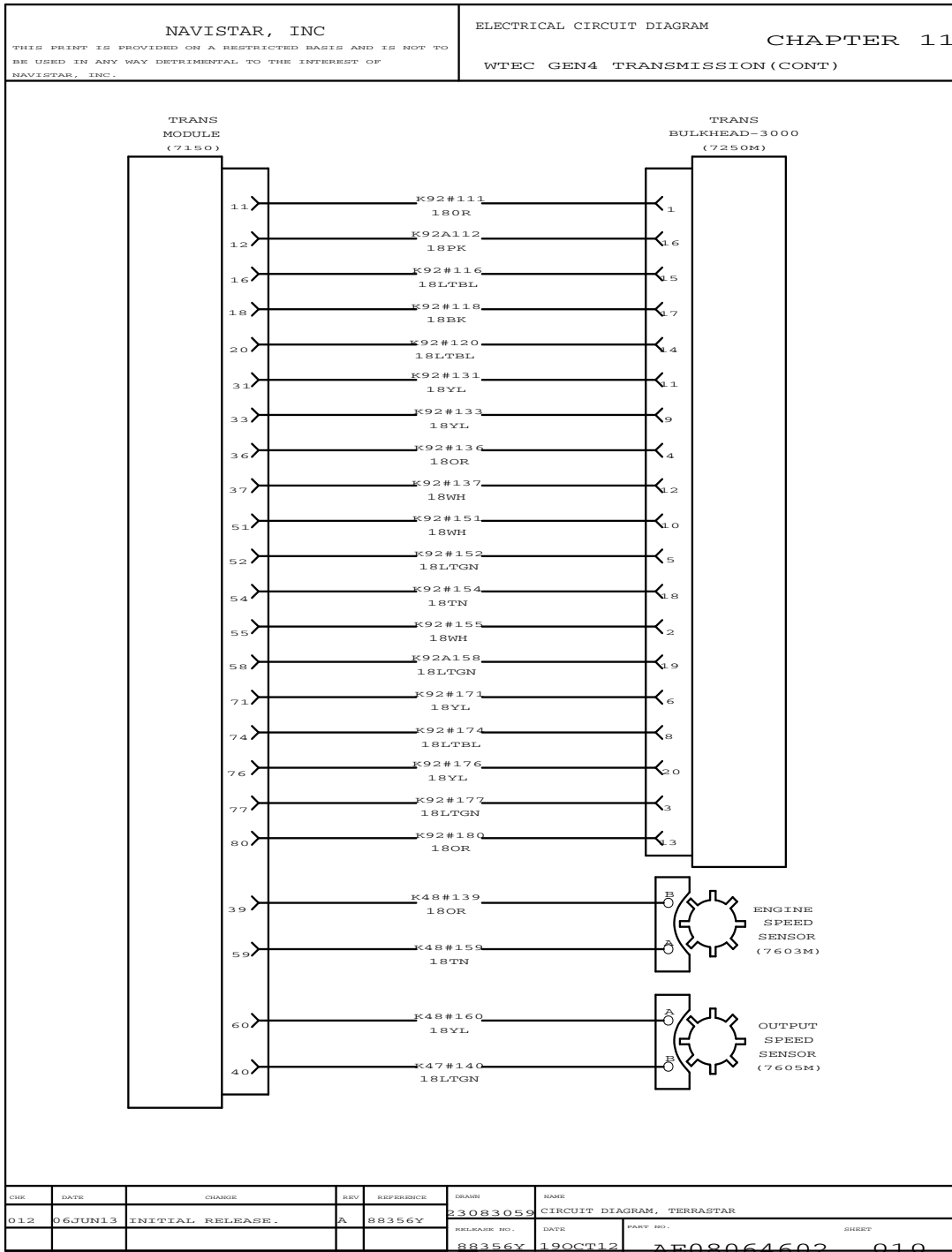

Figure 148 WTEC GEN 4 Transmission (Cont.)

11.11. TRANSMISSION RETARDER CONTROLS WIRING WITH MD TRANSMISSION HARD WIRED EFFECTS, P. 11

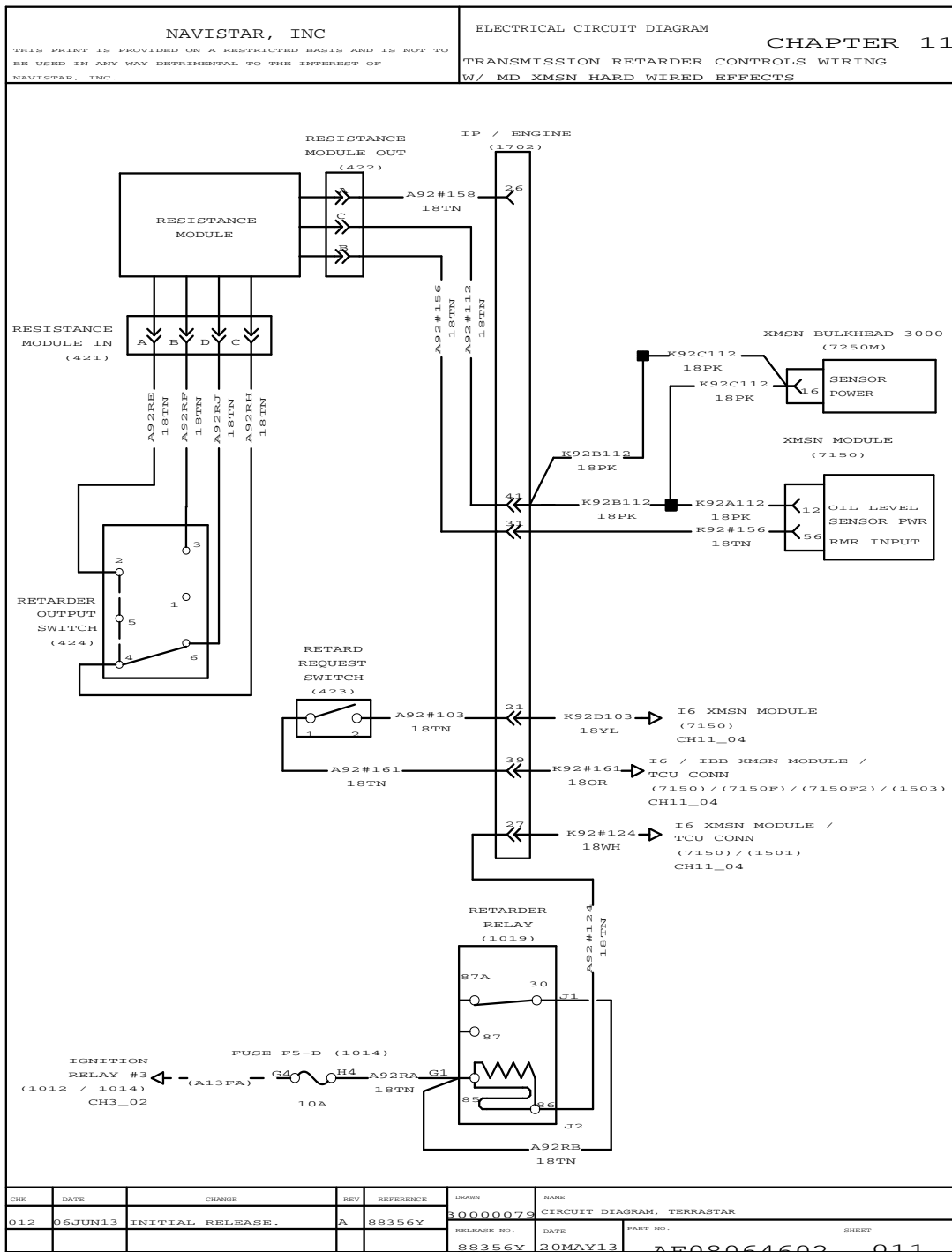

Figure 149 Transmission Retarder Controls Wiring with MD Transmission Hard Wired Effects

AIR CONDITIONING (CHAPTER 12)

12.1. HVAC SYSTEM, P. 1

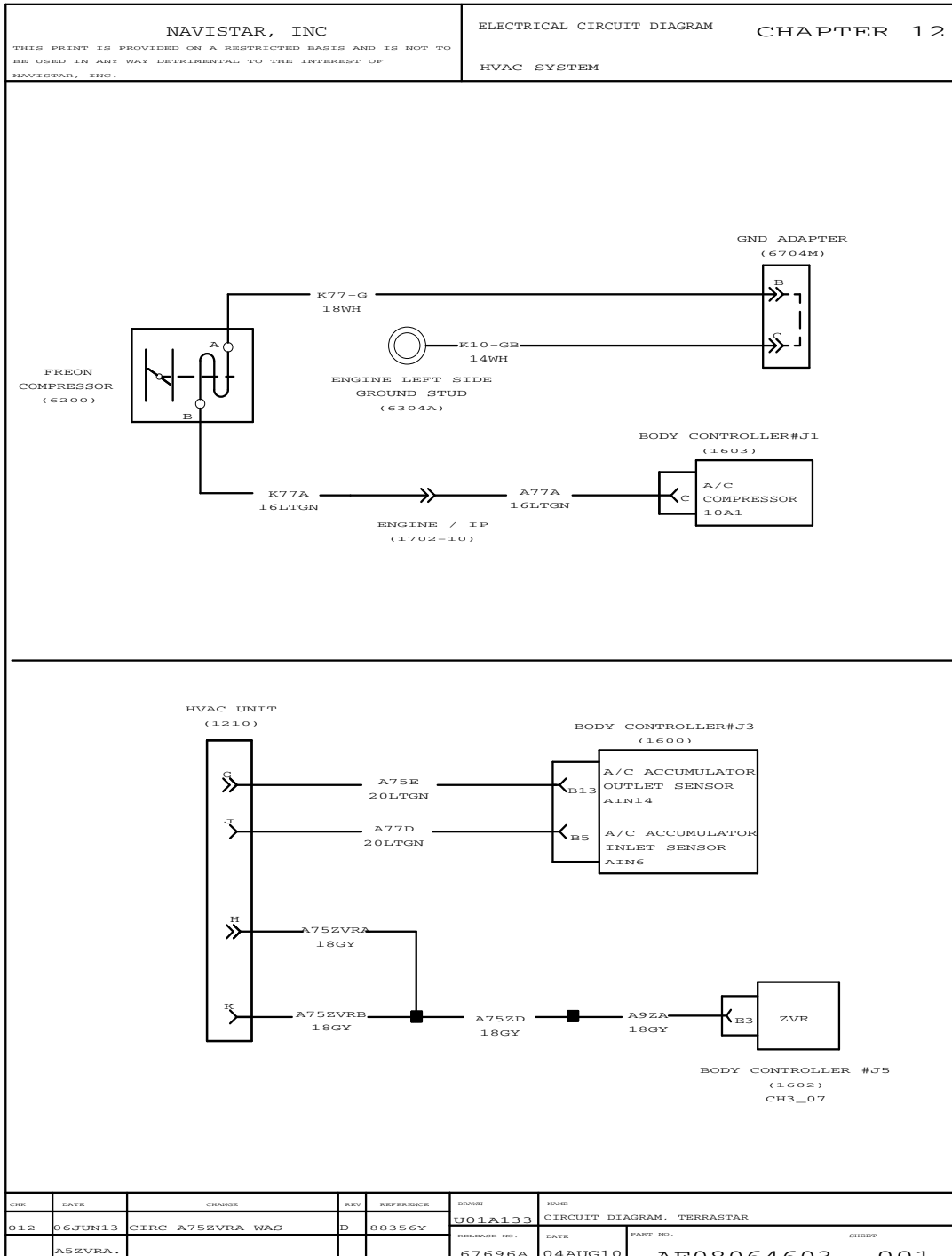

Figure 150 HVAC System

12.2. HVAC SYSTEM (CONT.), P. 2

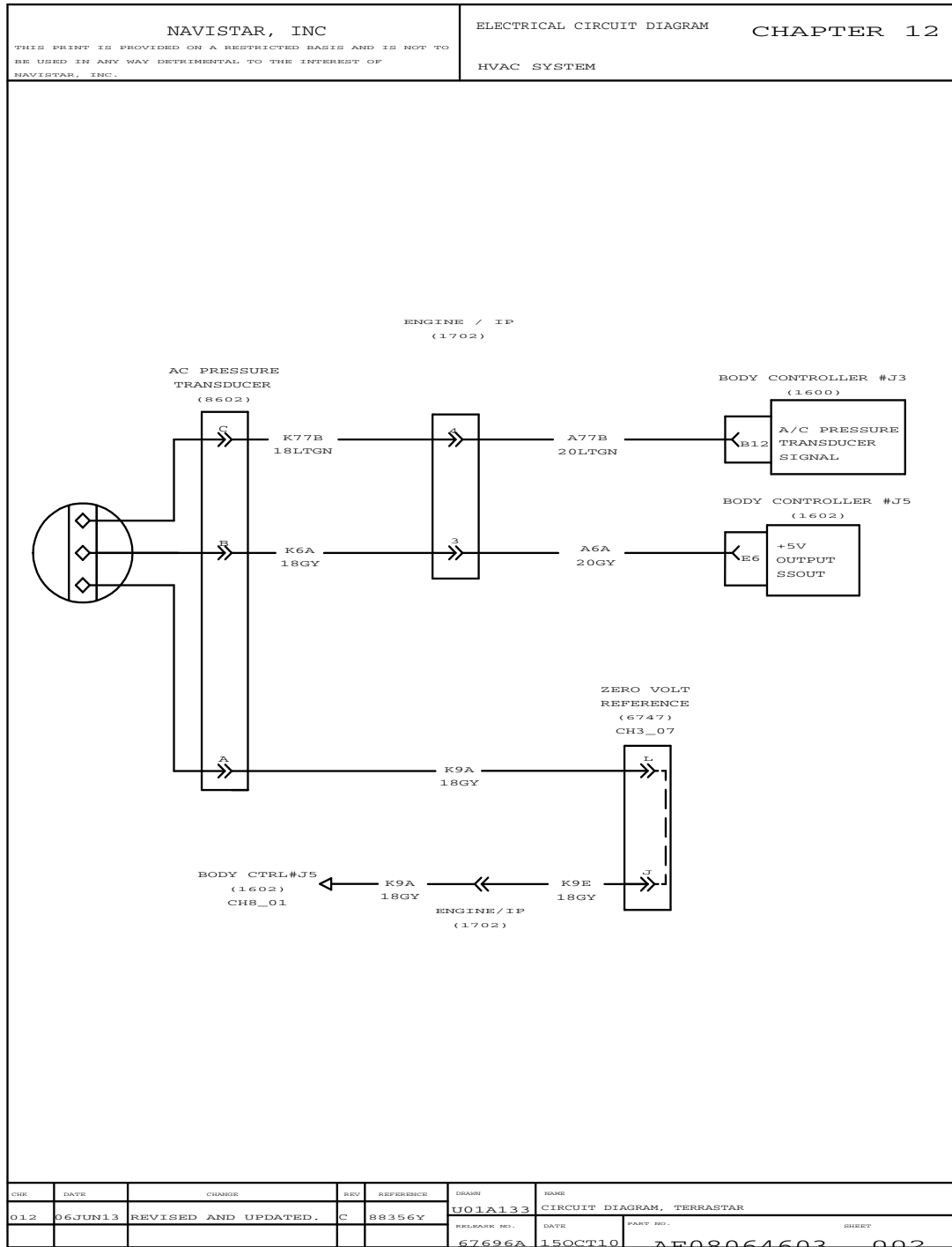

Figure 151 HVAC System

12.3. AIR CONDITIONING, P. 3

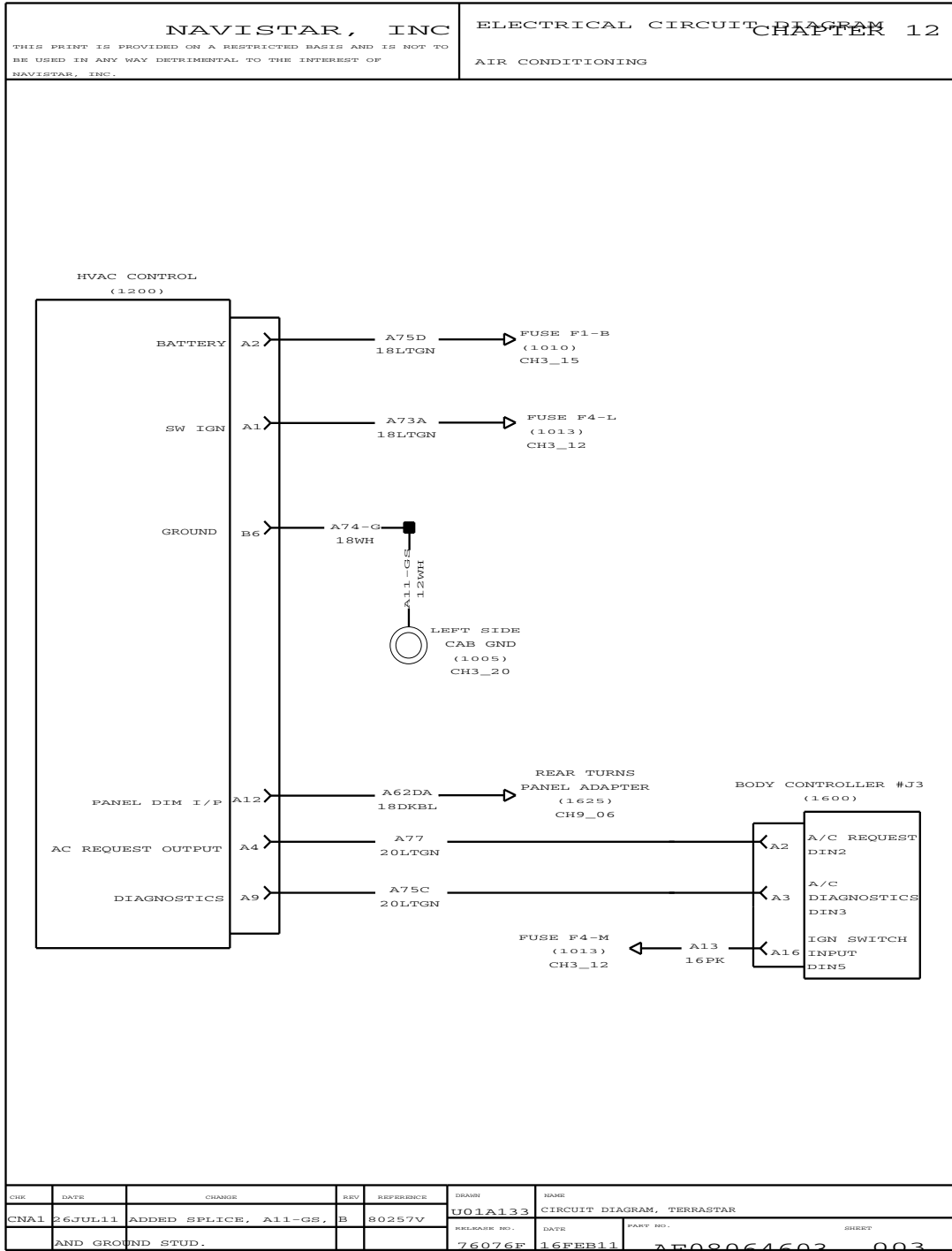

Figure 152 Air Conditioning

12.4. AIR CONDITIONING (CONT.), P. 4

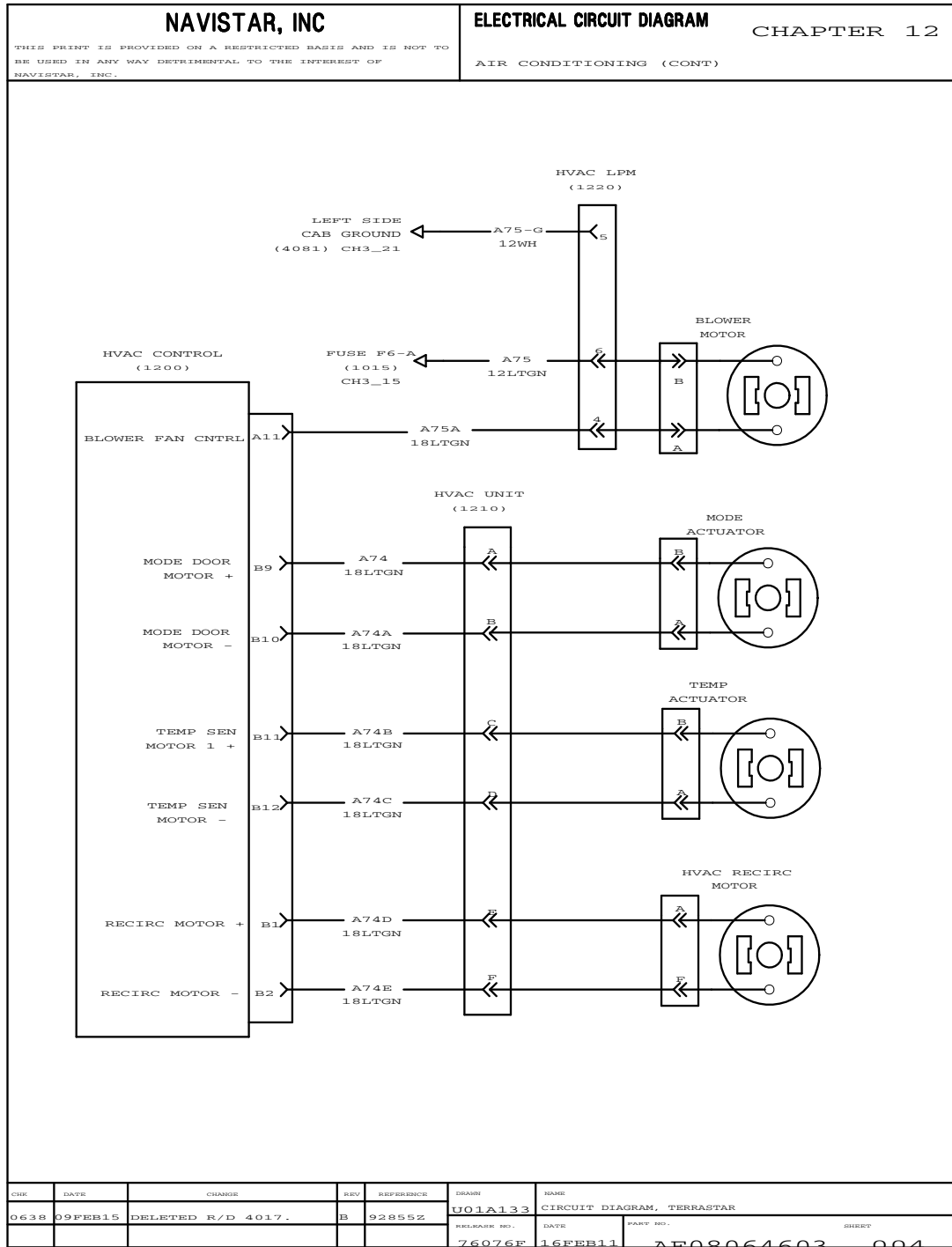

Figure 153 Air Conditioning (Cont.)

CONNECTOR BODY COMPOSITES (CHAPTER 13)

13.1. CONNECTOR BODY COMPOSITES (71 / 72 / 254F / 254M / 400), P. 1

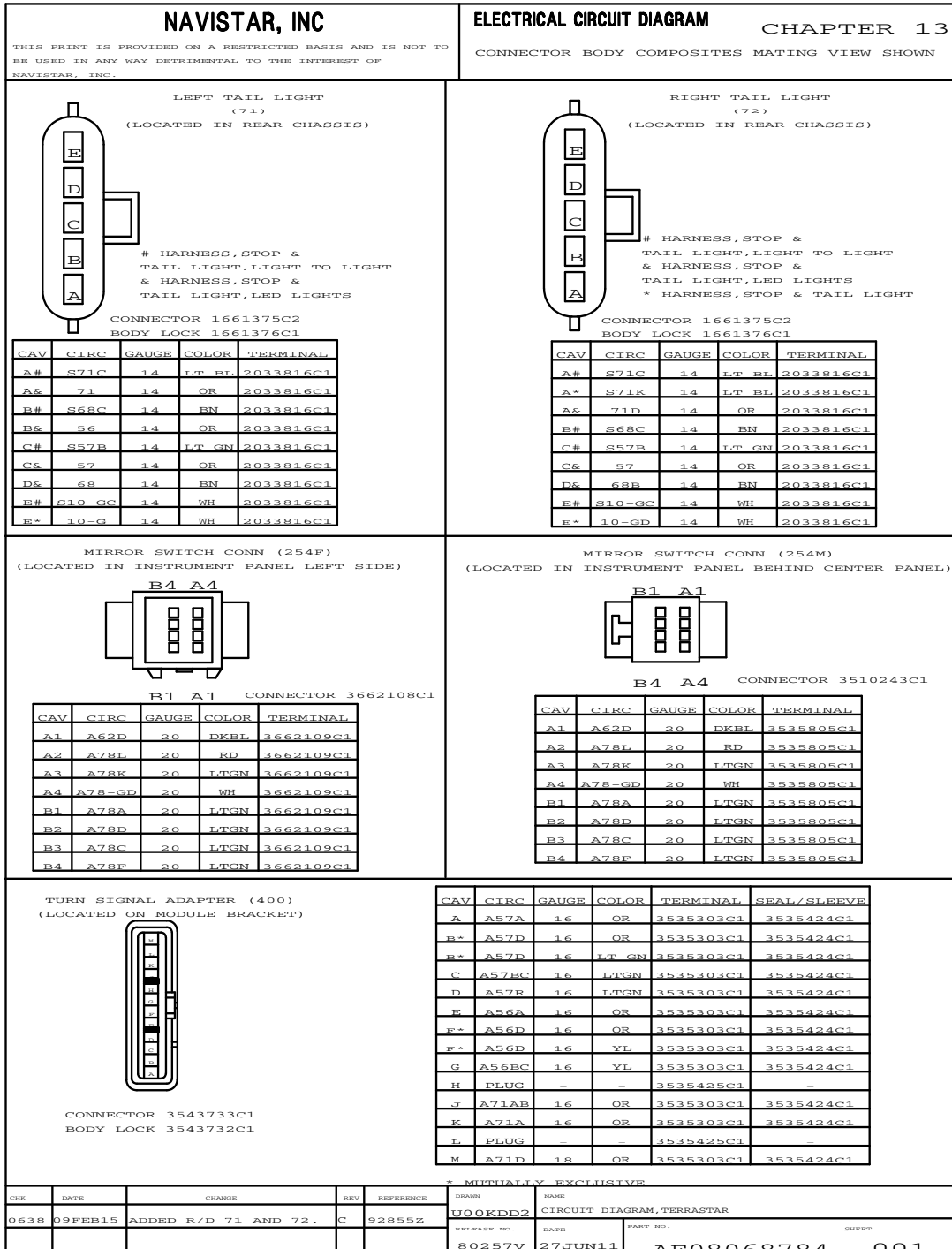
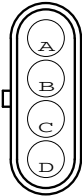

Figure 154 Connector Body Composites (71 / 72 / 254F / 254M / 400)

13.2. CONNECTOR BODY COMPOSITES (421 / 422 / 422F / 423), P. 2

NAVISTAR, INC		ELECTRICAL CIRCUIT DIAGRAM		CHAPTER 13	
THIS PRINT IS PROVIDED ON A RESTRICTED BASIS AND IS NOT TO BE USED IN ANY WAY DETRIMENTAL TO THE INTEREST OF NAVISTAR, INC.		CONNECTOR BODY COMPOSITES MATING VIEW SHOWN			

RESISTANCE MODULE IN (421)
(LOCATED IN INSTRUMENT PANEL CENTER)



CAV	CIRC	GAUGE	COLOR	TERMINAL	SEAL/SLEEVE
A	A92RE	18	TN	0587578C1	3517771C1
B	A92RF	18	TN	0587578C1	3517771C1
C	A92RH	18	TN	0587578C1	3517771C1
D	A92RJ	18	TN	0587578C1	3517771C1

CONNECTOR 0587571C91

RESISTANCE MODULE OUT (422)
(LOCATED IN INSTRUMENT PANEL CENTER)

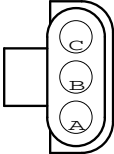

CAV	CIRC	GAUGE	COLOR	TERMINAL	SEAL/SLEEVE
A	A92#158	18	TN	0587578C1	3517771C1
B	A92#156	18	TN	0587578C1	3517771C1
C	A92#112	18	TN	0587578C1	3517771C1

CONNECTOR 3519221C91

LCT T HANDLE SHIFTER (422F)
(LOCATED IN INSTRUMENT PANEL)

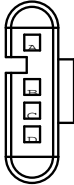

CAV	CIRC	GAUGE	COLOR	TERMINAL	SEAL/SLEEVE
A	A92A163	16	TN	1661875C1	1661872C1
B	A92D	18	TN	1661875C1	3568570C1
C	A92#142	18	TN	1661875C1	3568570C1
D*	A92A103	18	TN	1661875C1	3568570C1
D*	A92#103	18	TN	1661875C1	3568570C1
D*	A92B103	18	TN	1661875C1	3568570C1

CONNECTOR 3540756C1
BODY LOCK 3540758C1

* MUTUALLY EXCLUSIVE

RETARD REQUEST SWITCH (423)
(LOCATED IN INSTRUMENT PANEL CENTER)

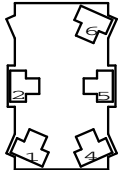

CAV	CIRC	GAUGE	COLOR	TERMINAL
1	A92#161	18	TN	1661224C1
2	A92#103	18	TN	1661224C1
4	PLUG	-	-	-
5	PLUG	-	-	-
6	PLUG	-	-	-

CONNECTOR 1673743C1

CHR	DATE	CHANGE	REV	REFERENCE	DRAWN	NAME		
0638	09FEB15	ADDED R/D 421, 422	C	92855Z	U00KDD2	CIRCUIT DIAGRAM, TERRASTAR		
	AND 423	REMOVED R/D 1800FA.			RELEASE NO.	DATE	PART NO.	SHEET
					80257V	A	AE08068784	002

Figure 155 Connector Body Composites (421 / 422 / 422F / 423)

13.3. CONNECTOR BODY COMPOSITES (424 / 828 / 1008FA), P. 2A

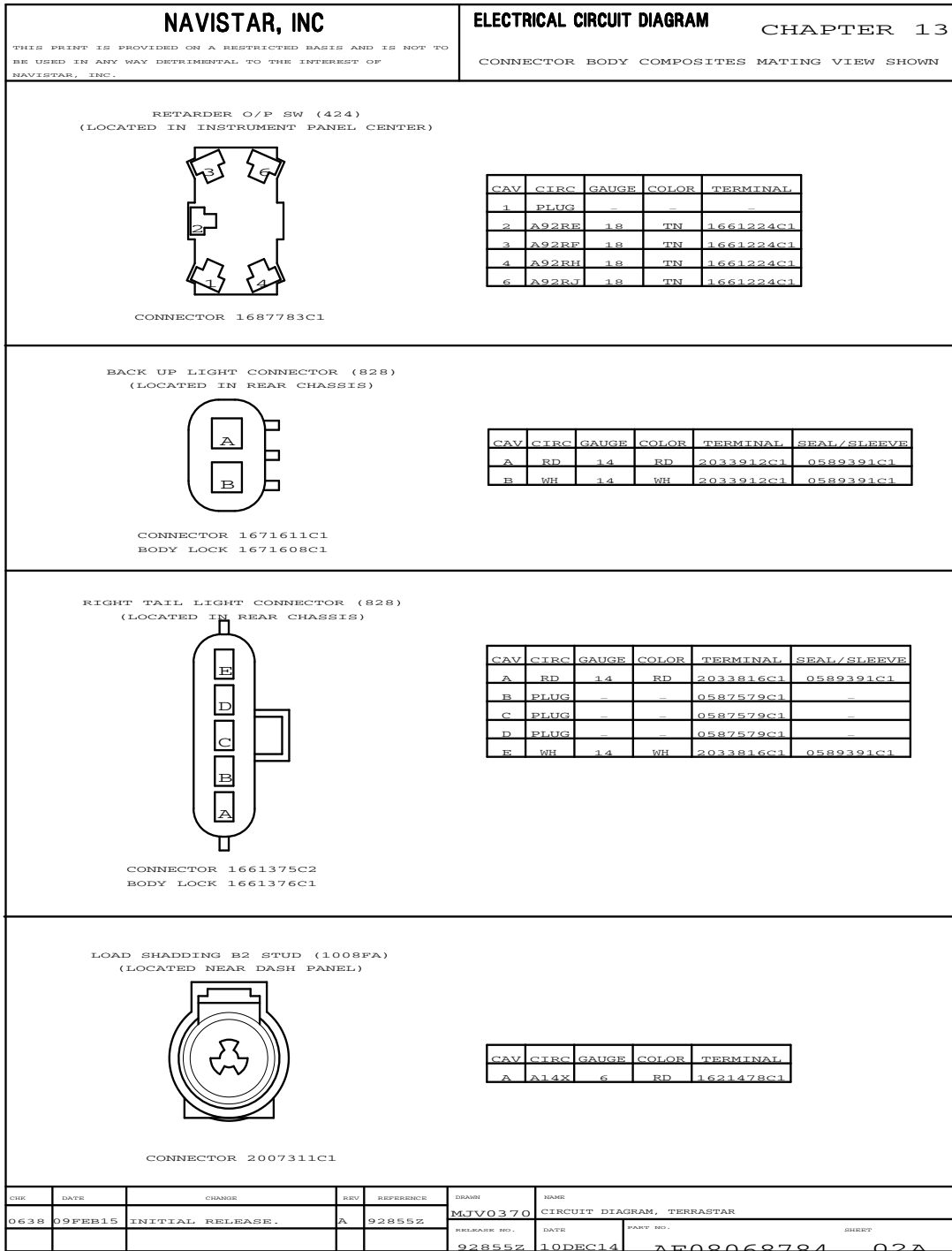

Figure 156 Connector Body Composites (424 / 828 / 1008FA)

13.4. CONNECTOR BODY COMPOSITES (1010), P. 3

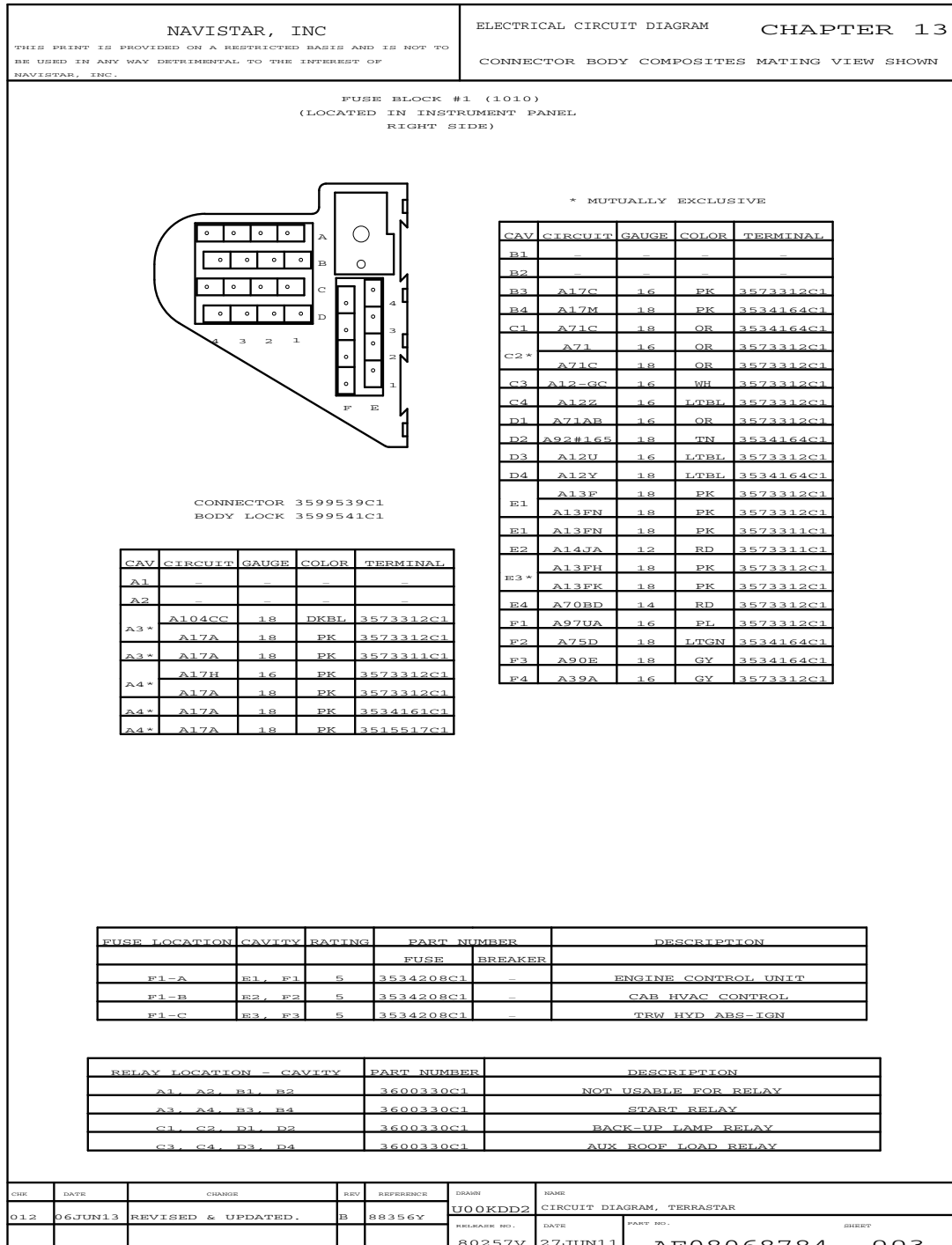

Figure 157 Connector Body Composites (1010)

13.5. CONNECTOR BODY COMPOSITES (1011), P. 4

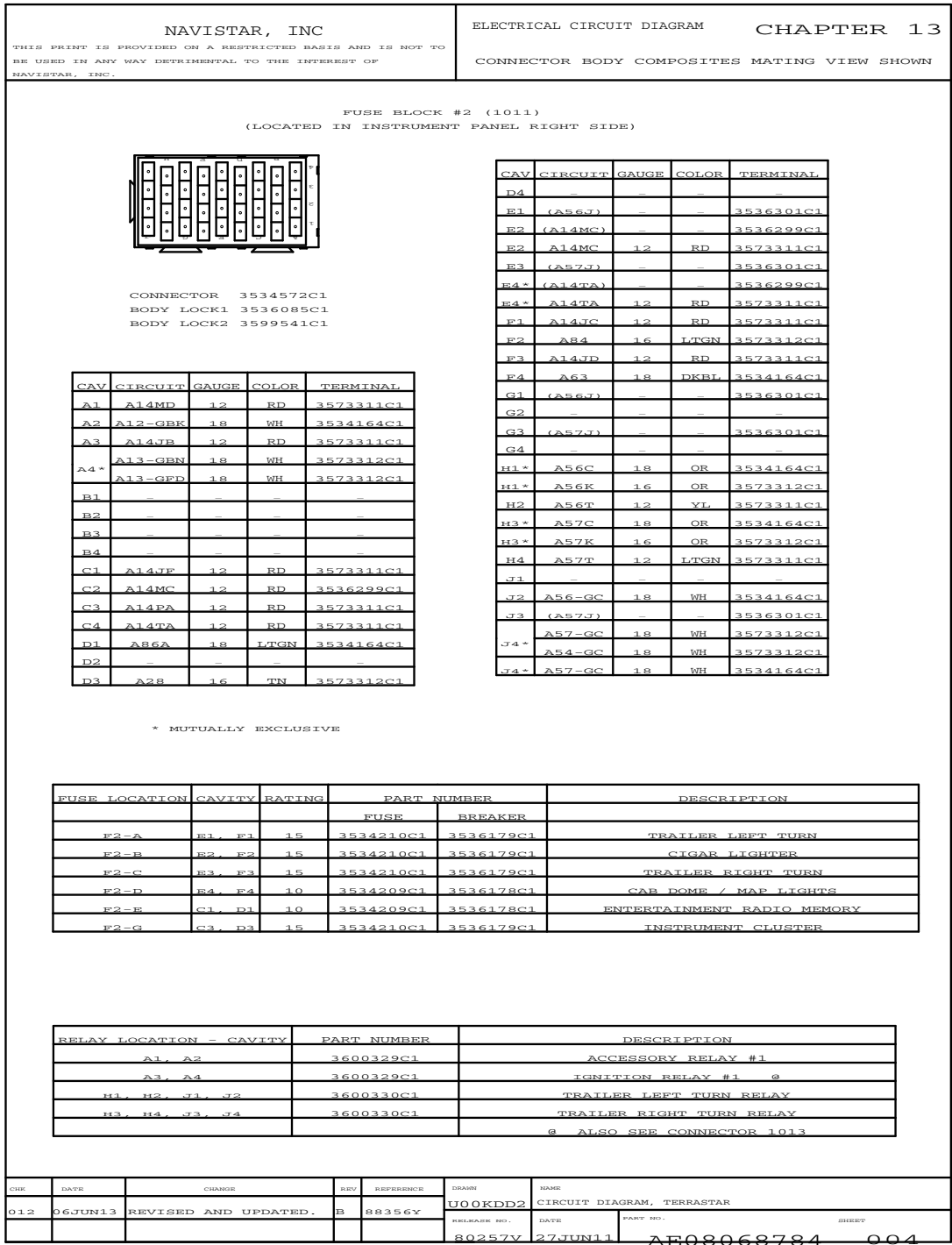

Figure 158 Connector Body Composites (1011)

13.6. CONNECTOR BODY COMPOSITES (1012), P. 5

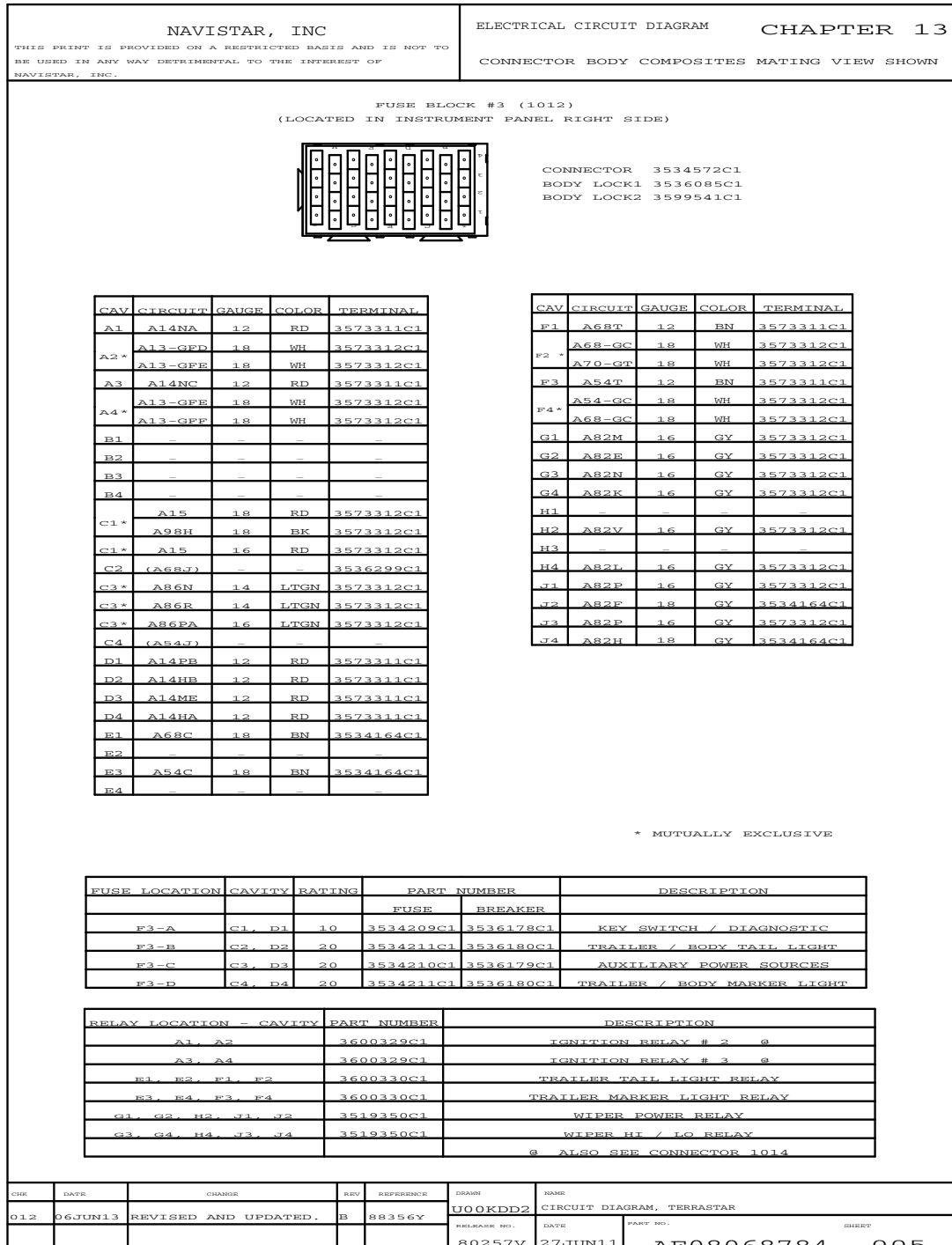

Figure 159 Connector Body Composites (1012)

13.7. CONNECTOR BODY COMPOSITES (1013), P. 6

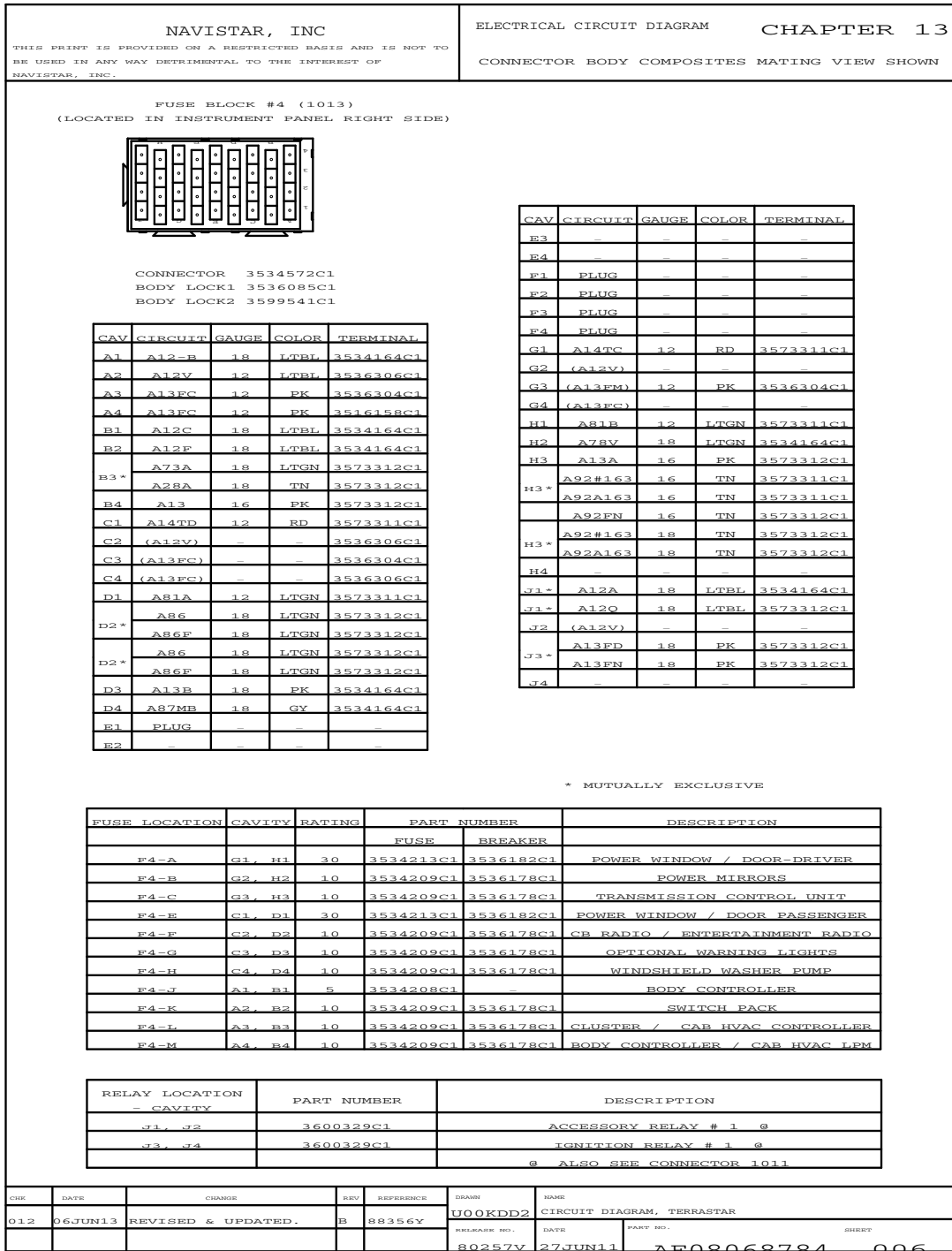

Figure 160 Connector Body Composites (1013)

13.8. CONNECTOR BODY COMPOSITES (1014), P. 7

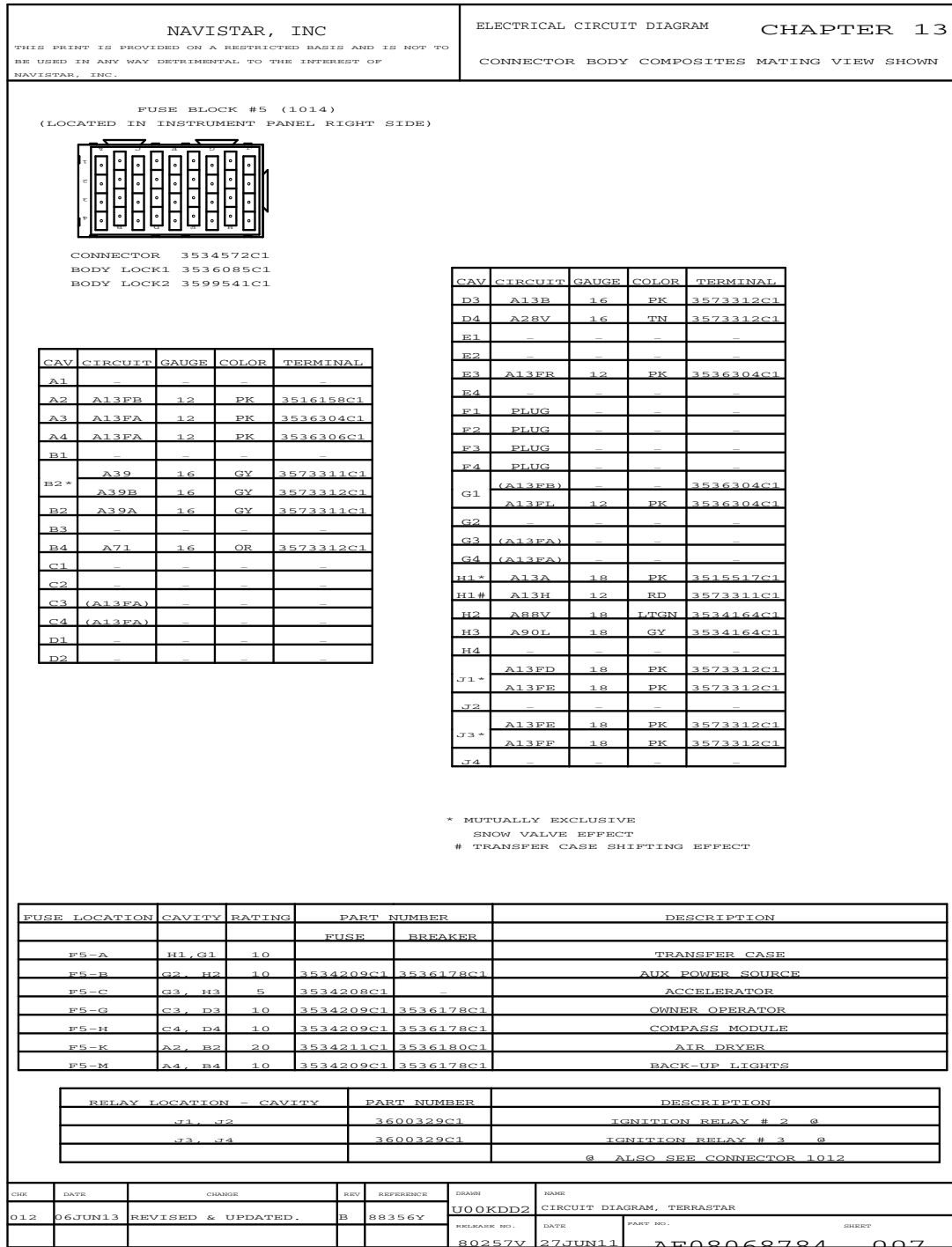

Figure 161 Connector Body Composites (1014)

13.9. CONNECTOR BODY COMPOSITES (1015), P. 8

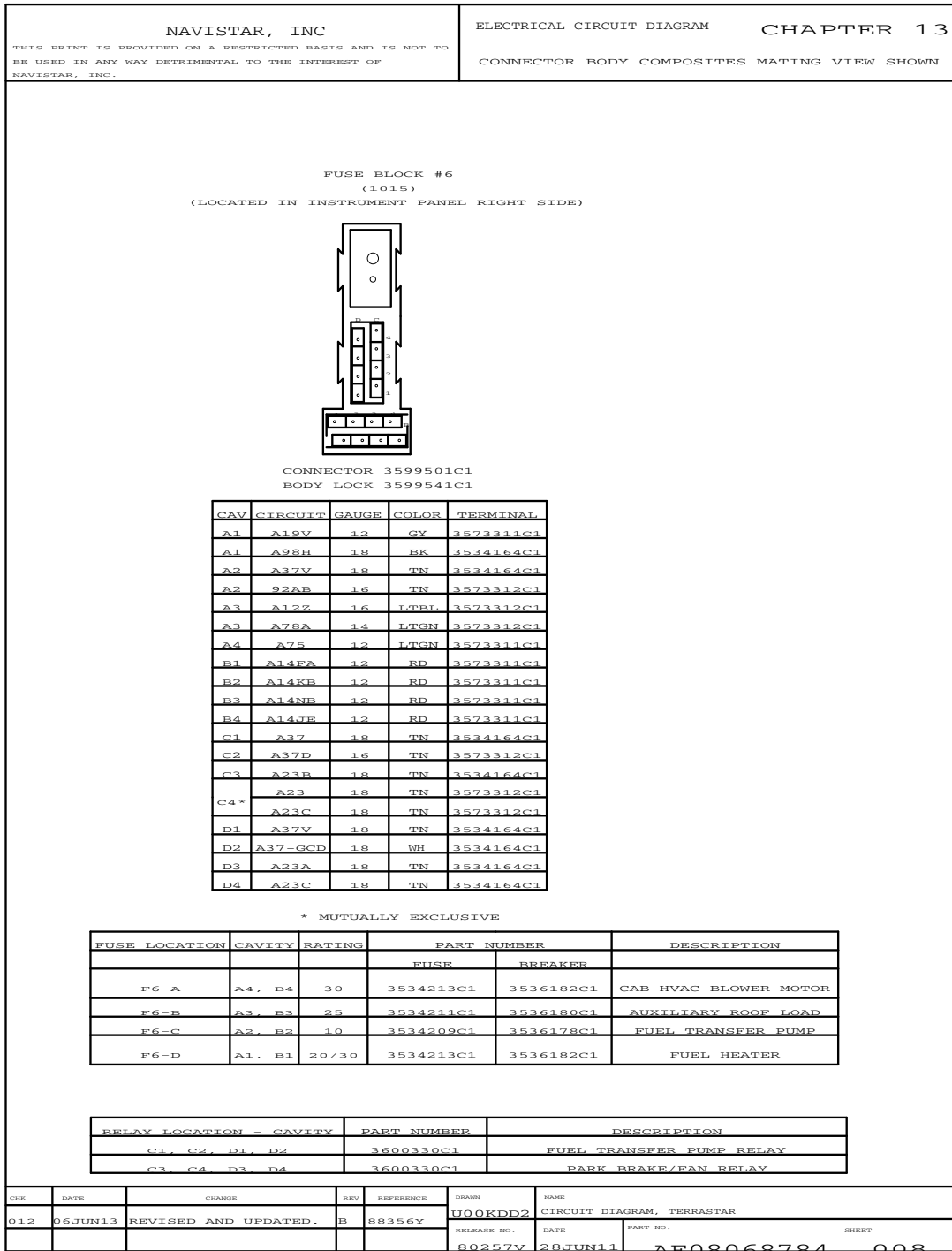

Figure 162 Connector Body Composites (1015)

13.10. CONNECTOR BODY COMPOSITES (1016), P. 9

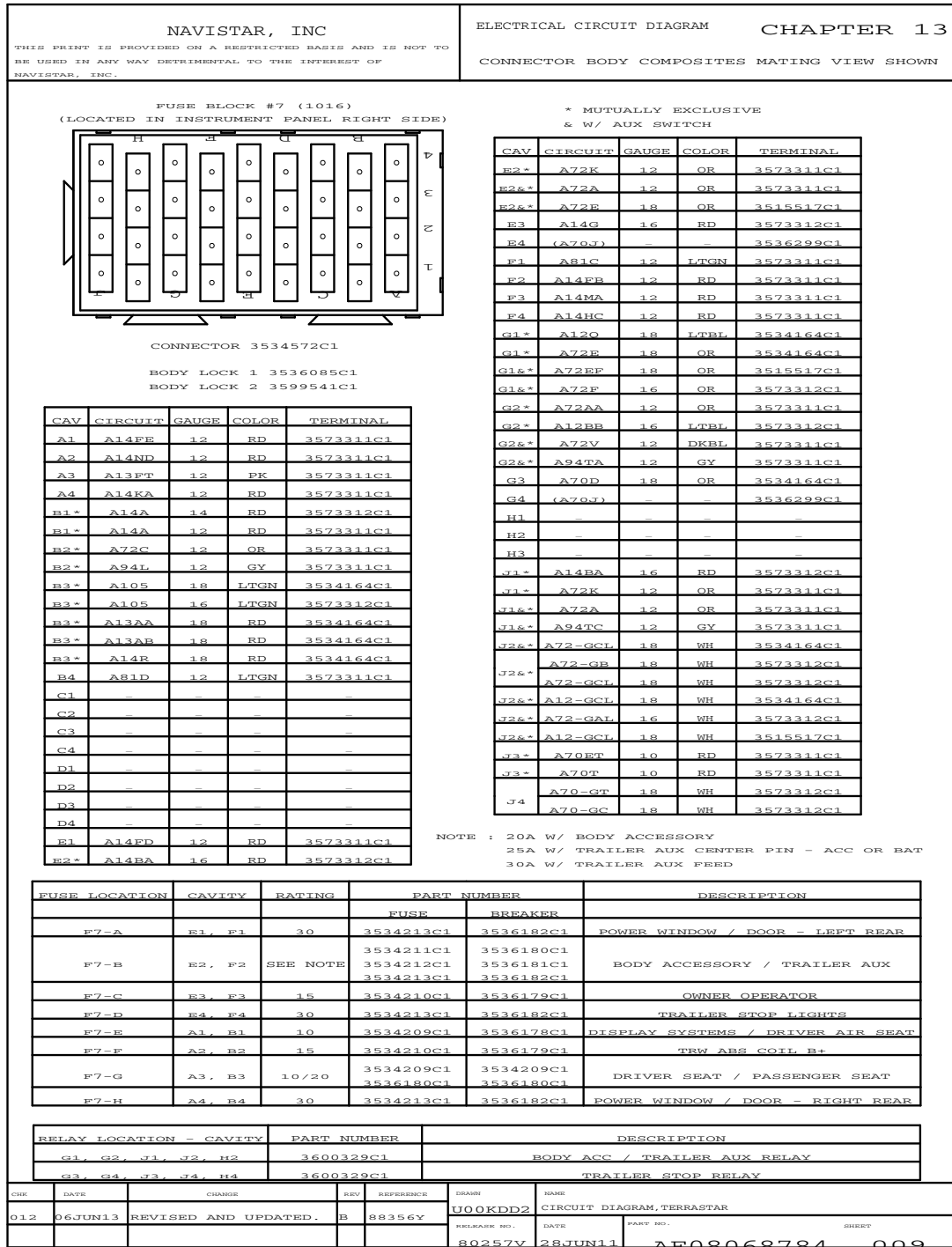

Figure 163 Connector Body Composites (1016)

13.11. CONNECTOR BODY COMPOSITES (1017), P. 10

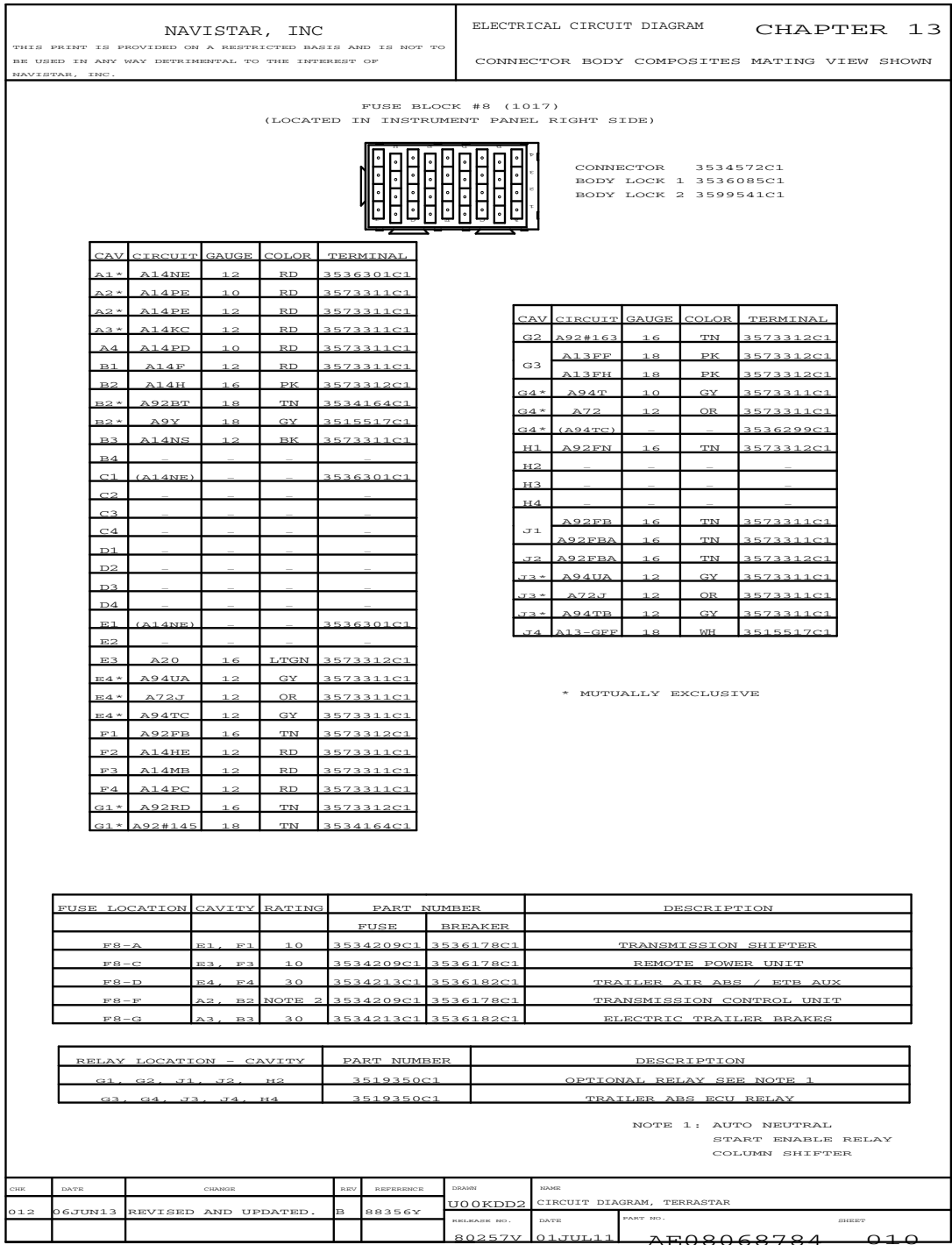

Figure 164 Connector Body Composites (1017)

13.12. CONNECTOR BODY COMPOSITES (1018), P. 11

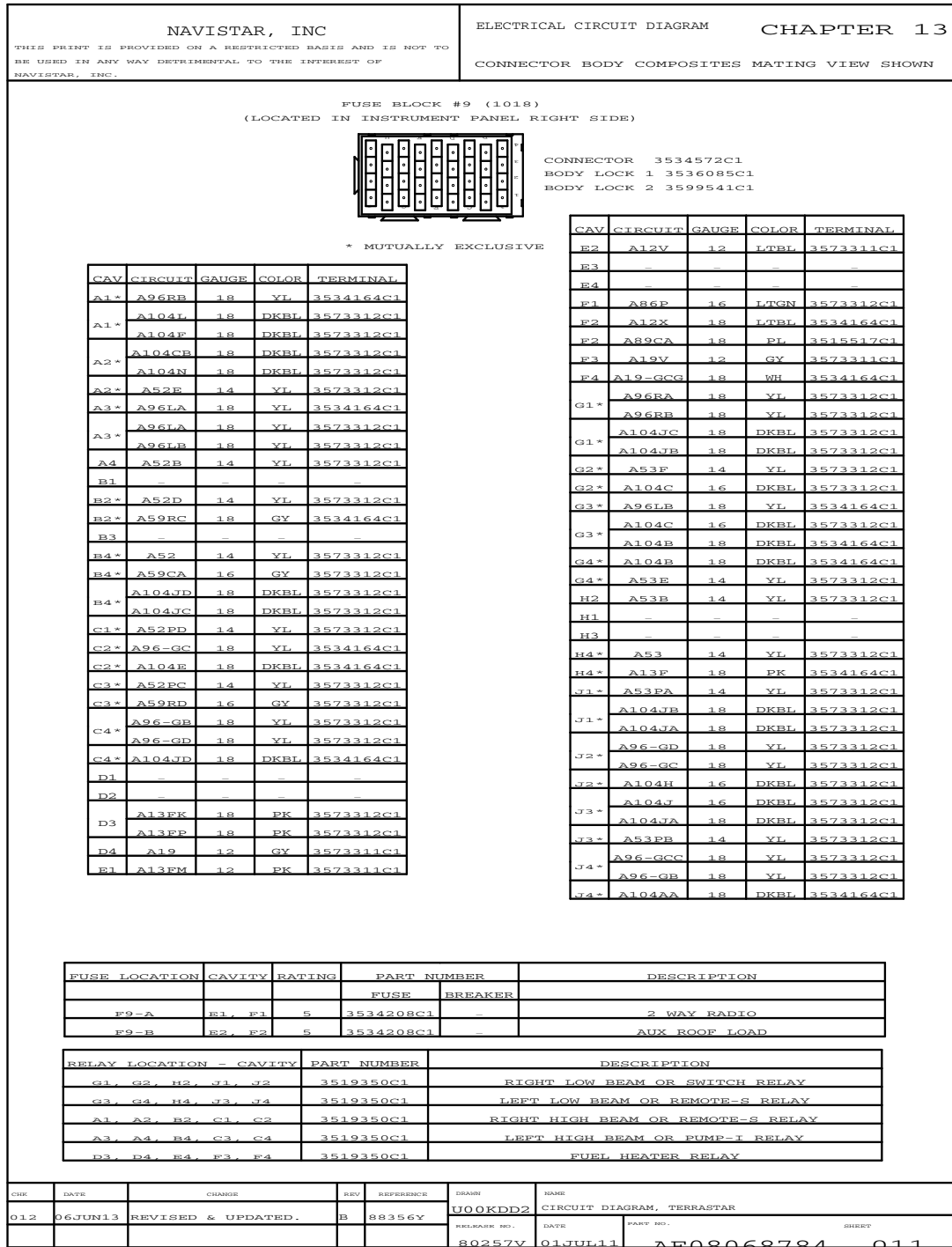

Figure 165 Connector Body Composites (1018)

13.13. CONNECTOR BODY COMPOSITES (1019), P. 12

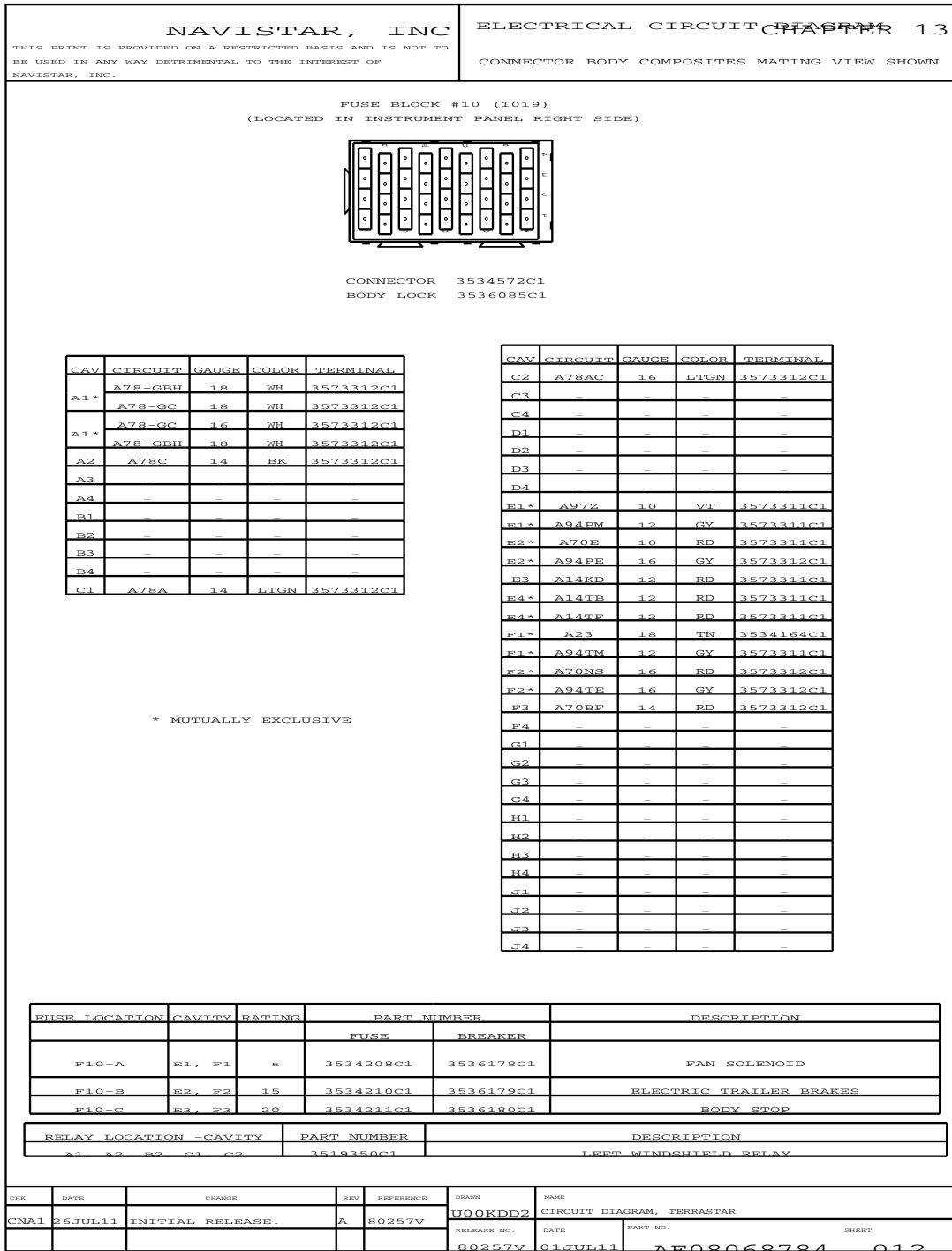

Figure 166 Connector Body Composites (1019)

13.14. CONNECTOR BODY COMPOSITES (1020), P. 13

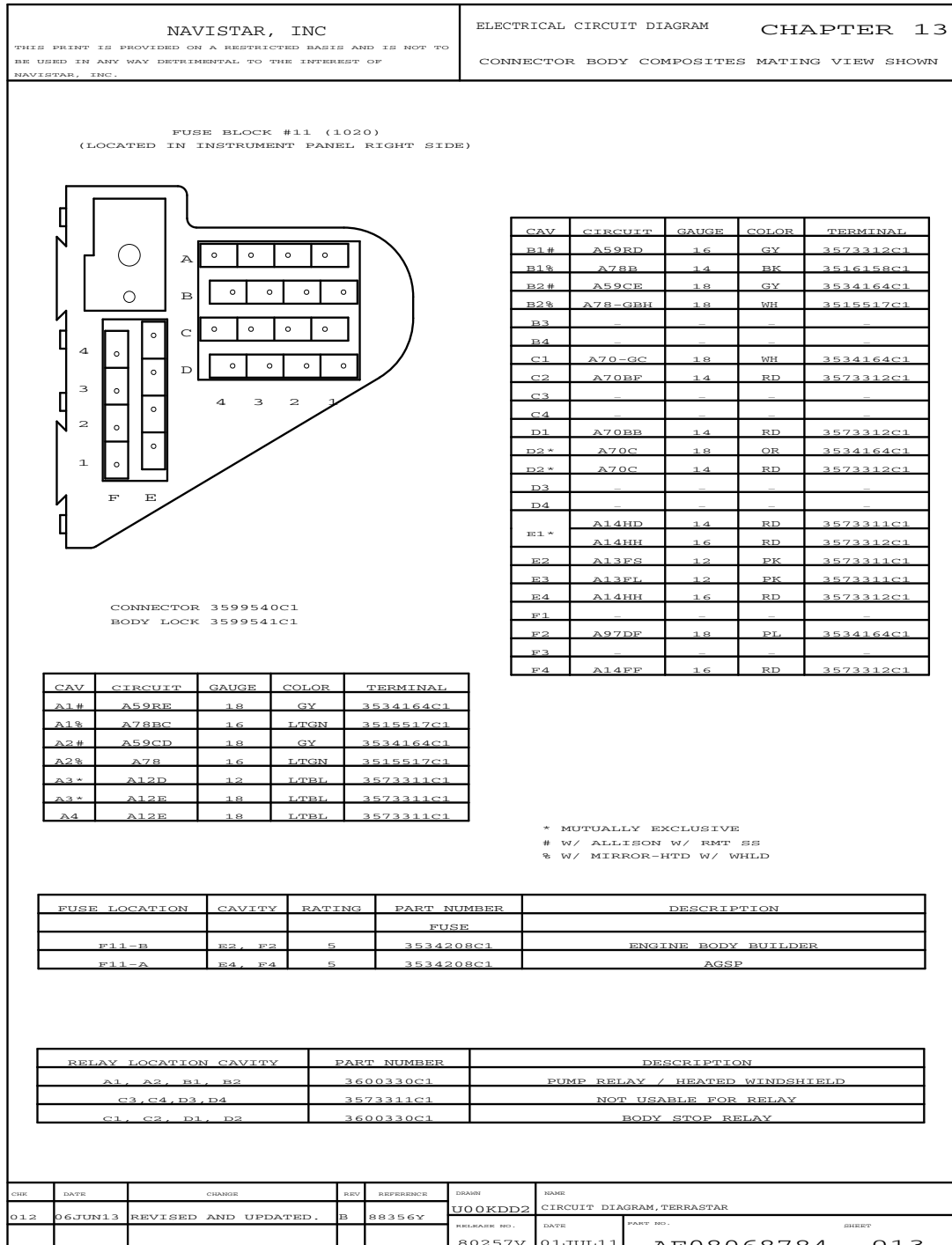

Figure 167 Connector Body Composites (1020)

13.15. CONNECTOR BODY COMPOSITES (1025 / 1026), P. 14

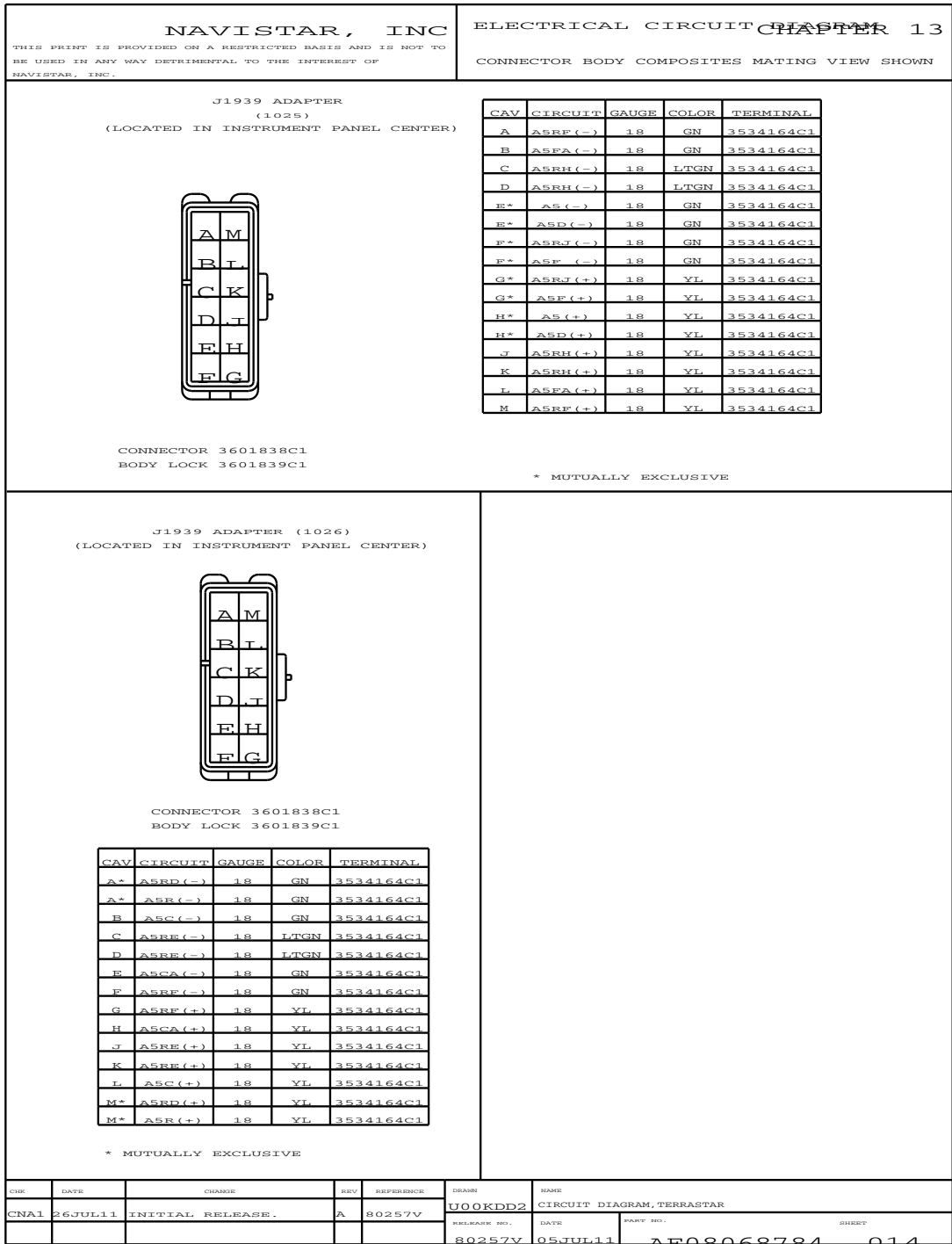

Figure 168 Connector Body Composites (1025 / 1026)

13.16. CONNECTOR BODY COMPOSITES (1100 / 1100MA / 1101 / 1101A), P. 15

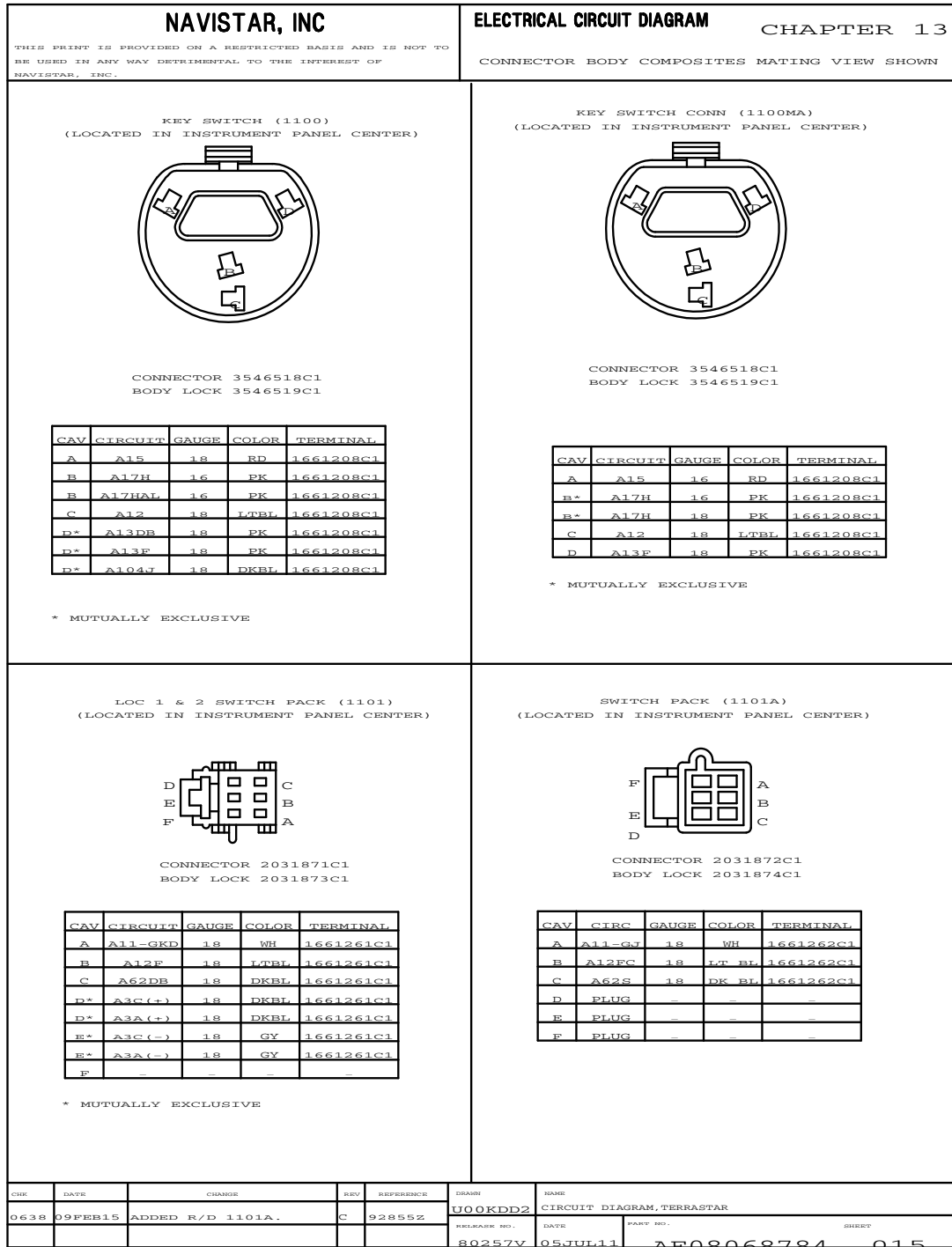

Figure 169 Connector Body Composites (1100 / 1100MA / 1101 / 1101A)

13.17. CONNECTOR BODY COMPOSITES (1106 / 1107), P. 16

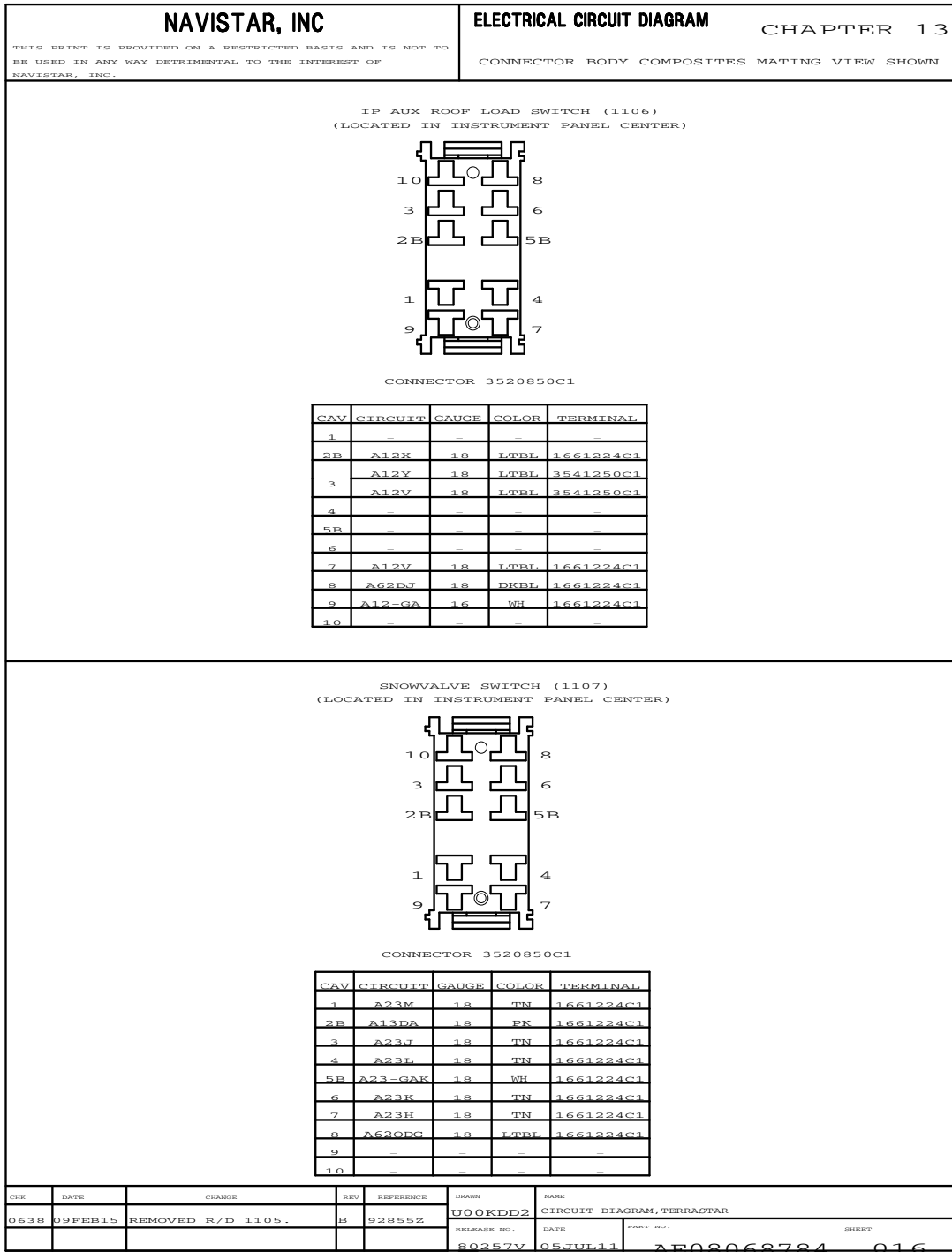

Figure 170 Connector Body Composites (1106 / 1107)

13.18. CONNECTOR BODY COMPOSITES (1110 / 1200 / 1210 / 1220), P. 17

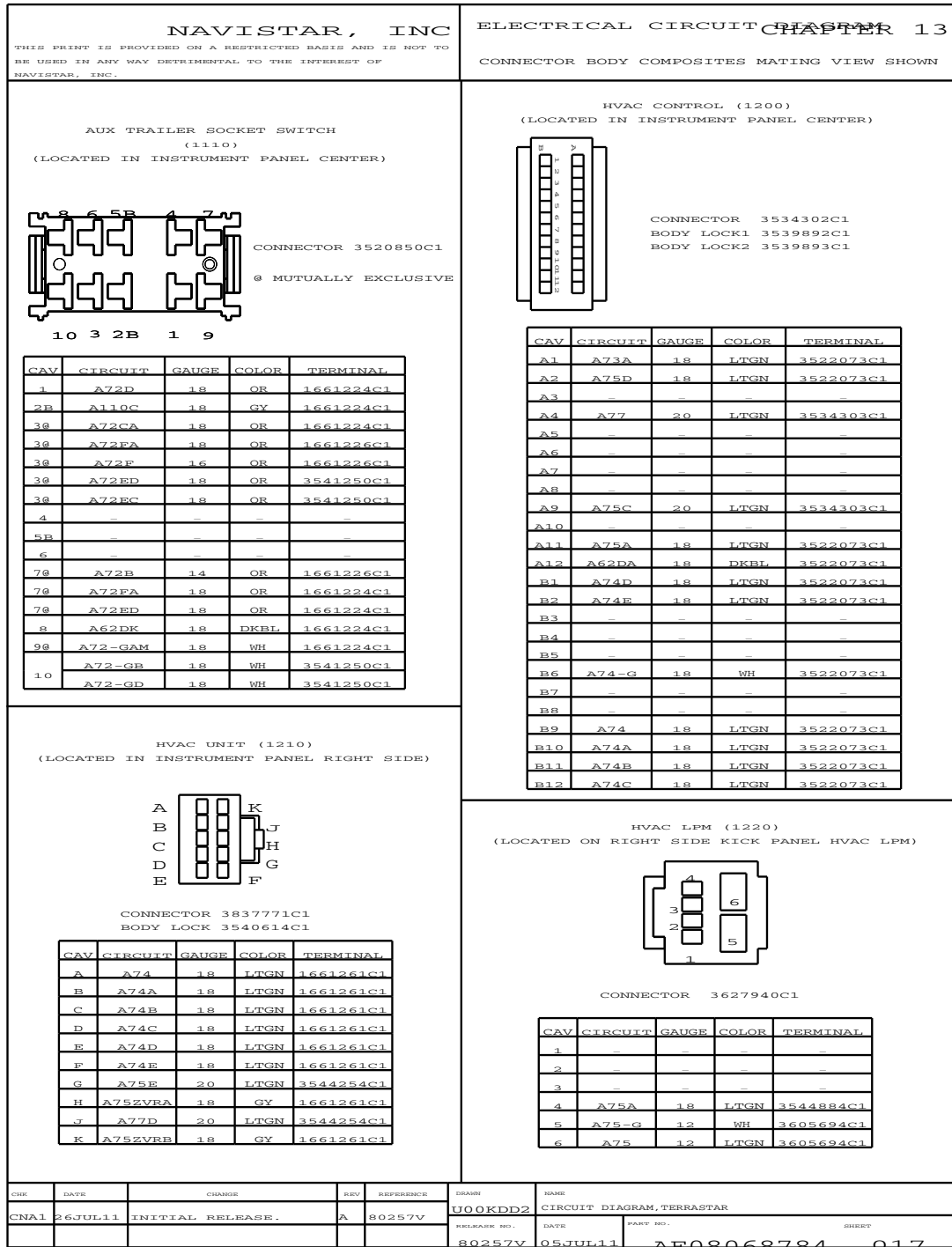

Figure 171 Connector Body Composites (1110 / 1200 / 1210 / 1220)

13.19. CONNECTOR BODY COMPOSITES (1300 / 1301 / 1500 / 1501), P. 18

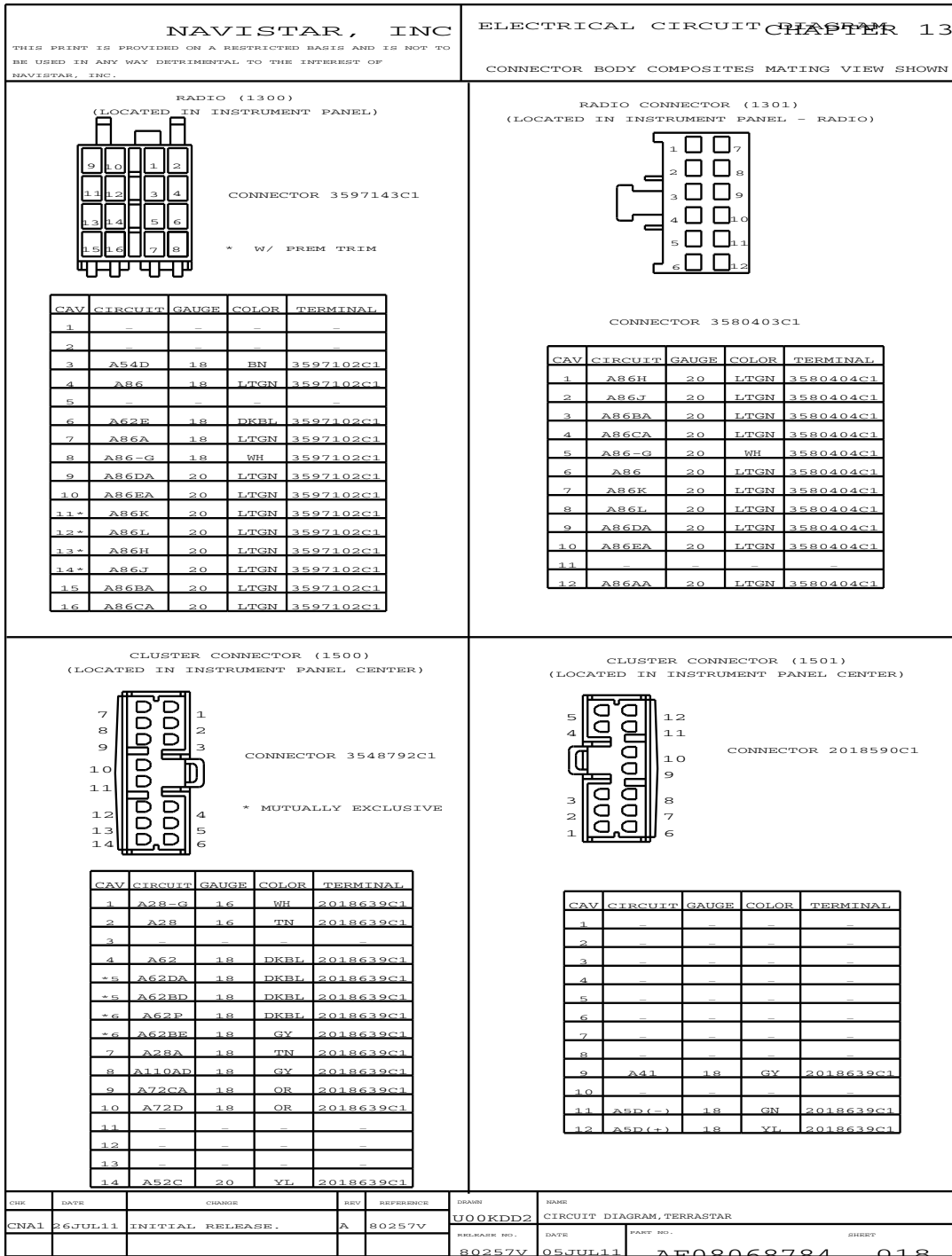

Figure 172 Connector Body Composites (1300 / 1301 / 1500 / 1501)

13.20. CONNECTOR BODY COMPOSITES (1501 / 1502 / 1503), P. 18A

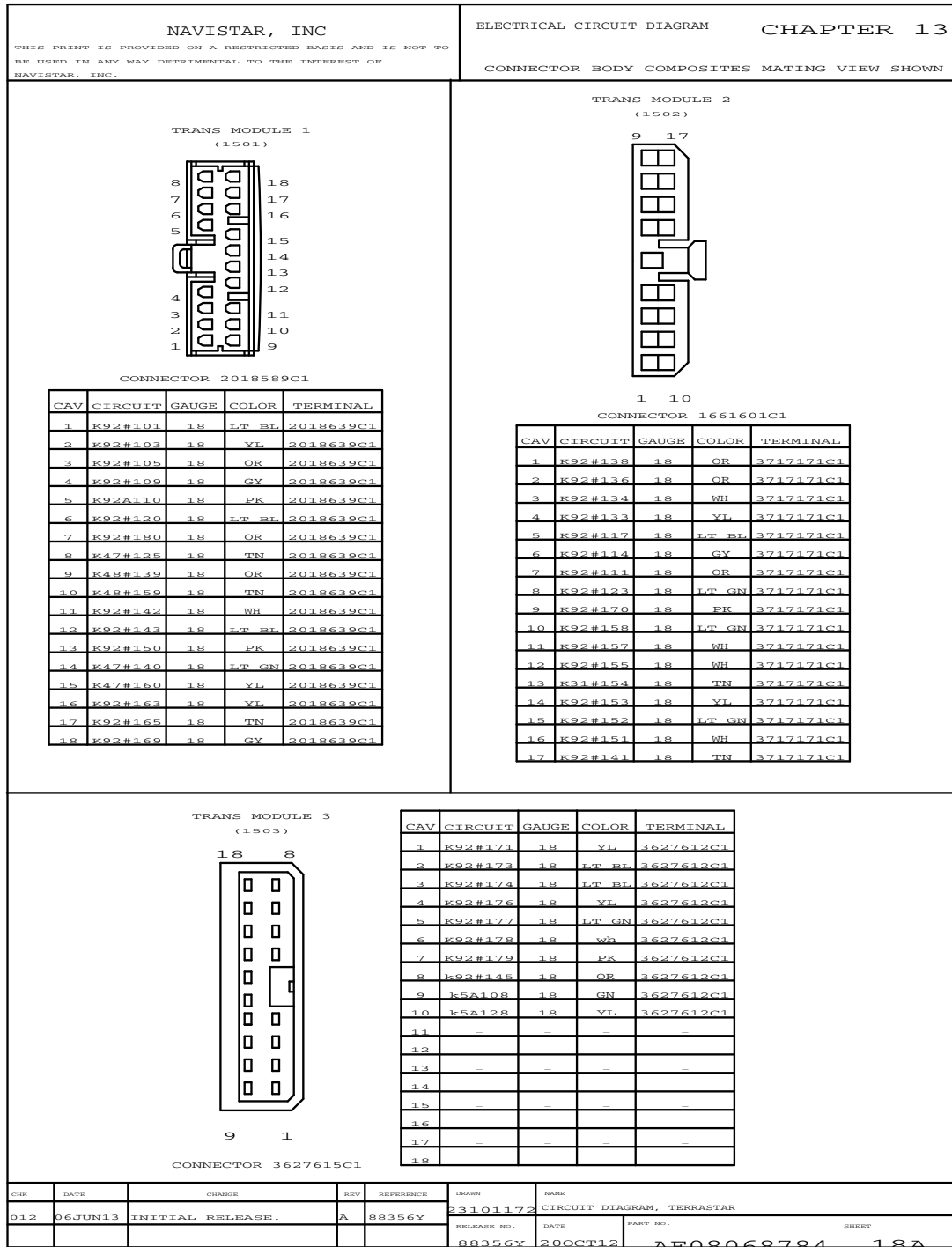

Figure 173 Connector Body Composites (1501 / 1502 / 1503)

13.21. CONNECTOR BODY COMPOSITES (1512 / 1600), P. 19

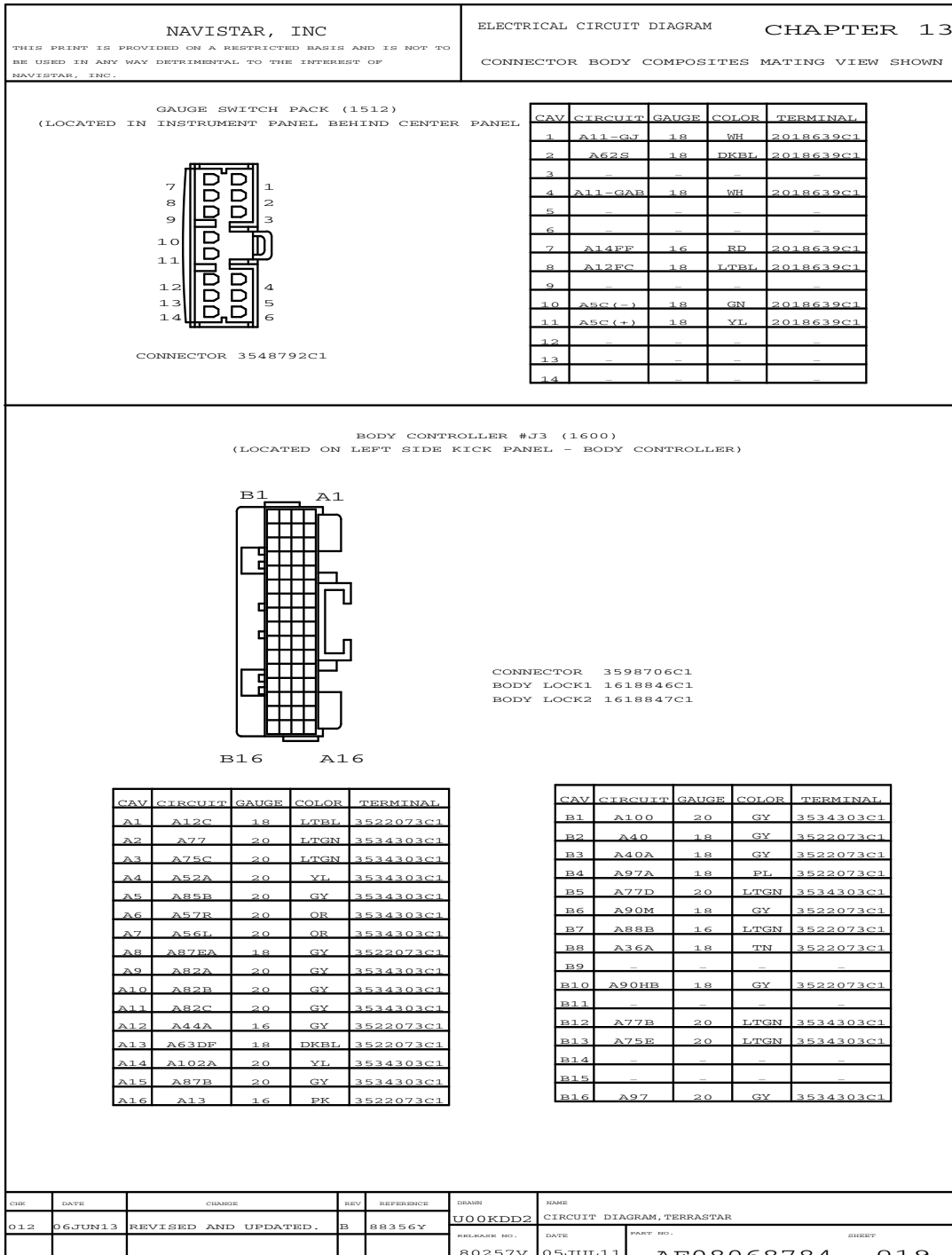

Figure 174 Connector Body Composites (1512 / 1600)

13.22. CONNECTOR BODY COMPOSITES (1601), P. 20

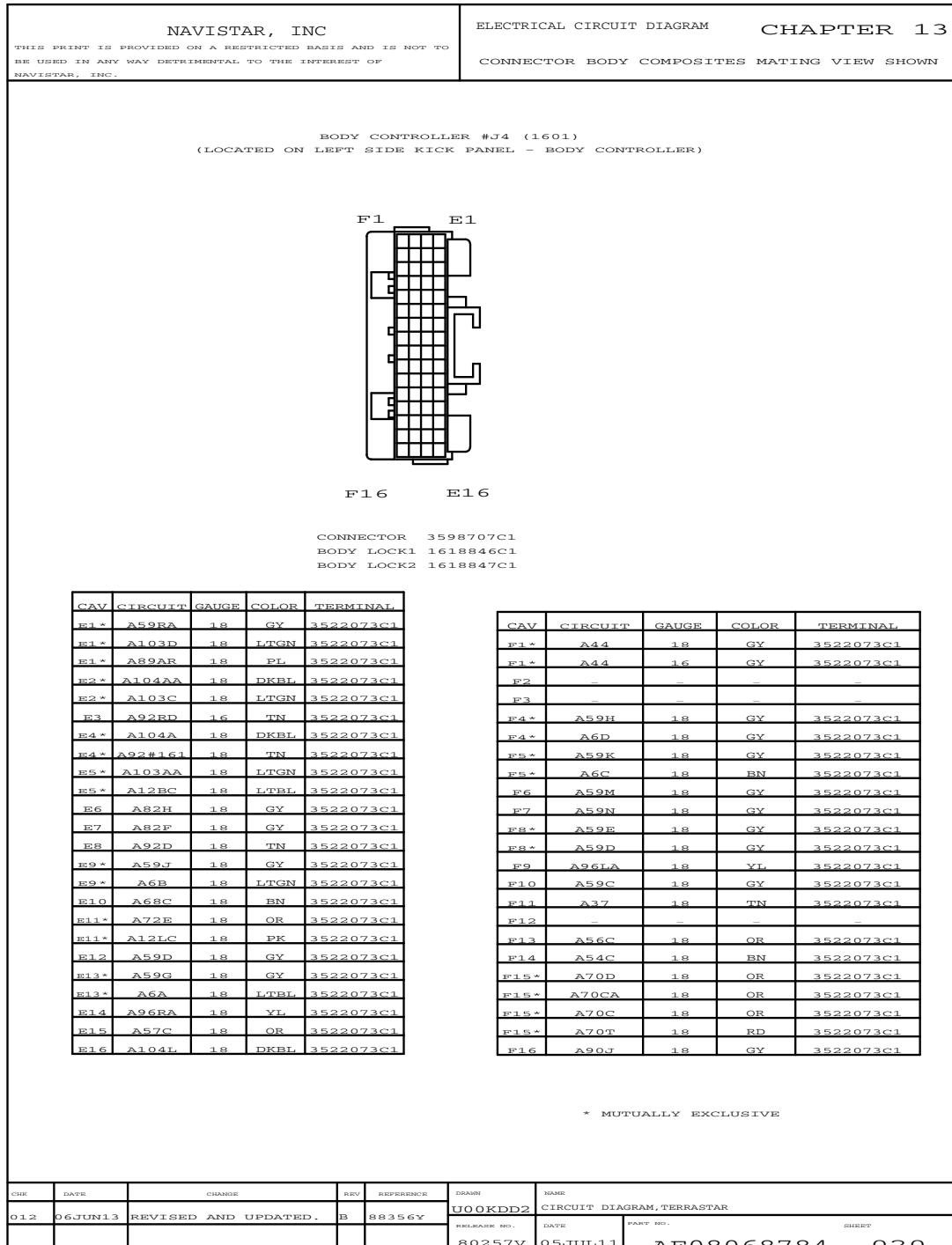

Figure 175 Connector Body Composites (1601)

13.23. CONNECTOR BODY COMPOSITES (1602), P. 21

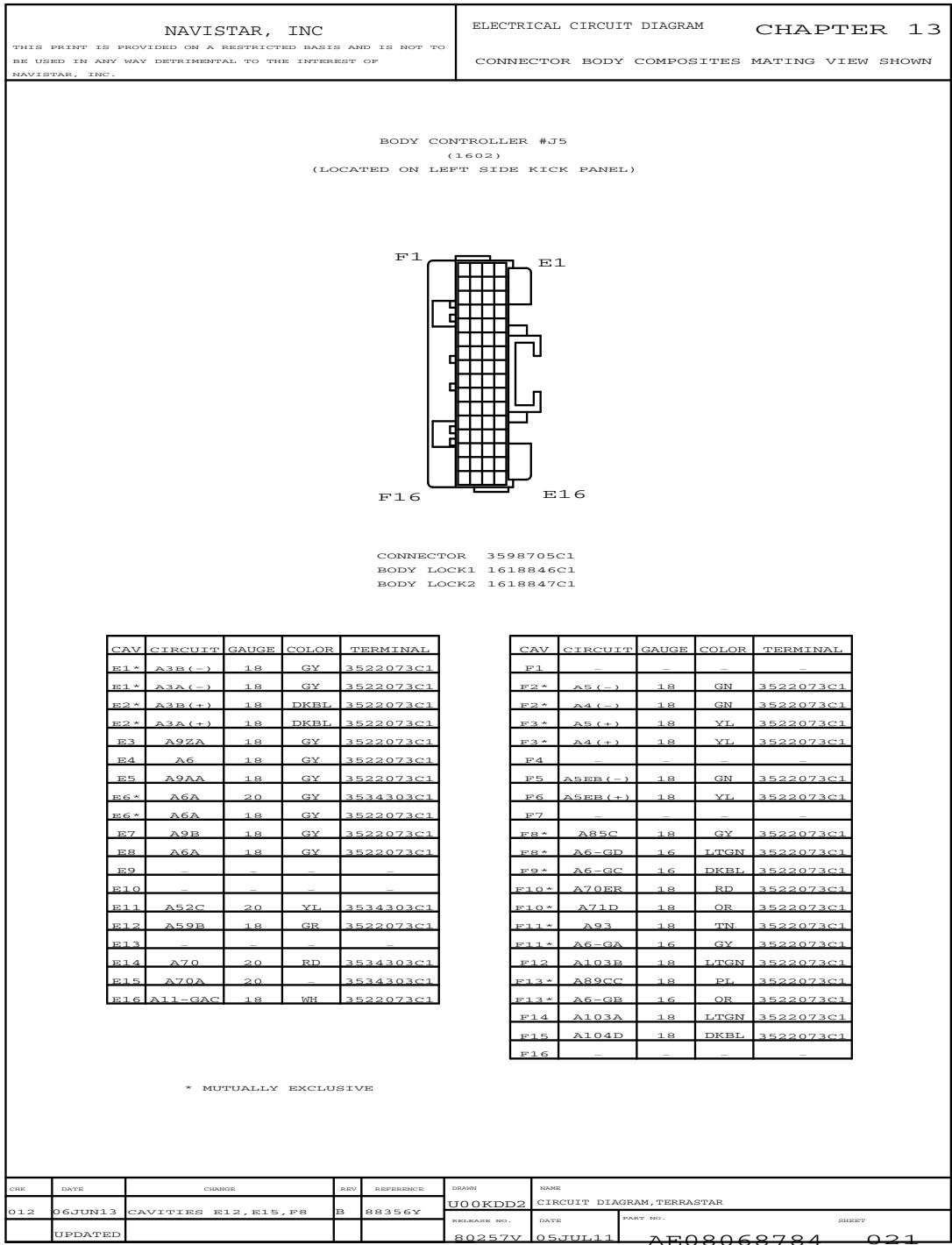

Figure 176 Connector Body Composites (1602)

13.24. CONNECTOR BODY COMPOSITES (1603 / 1604 / 1623 / 1625), P. 22

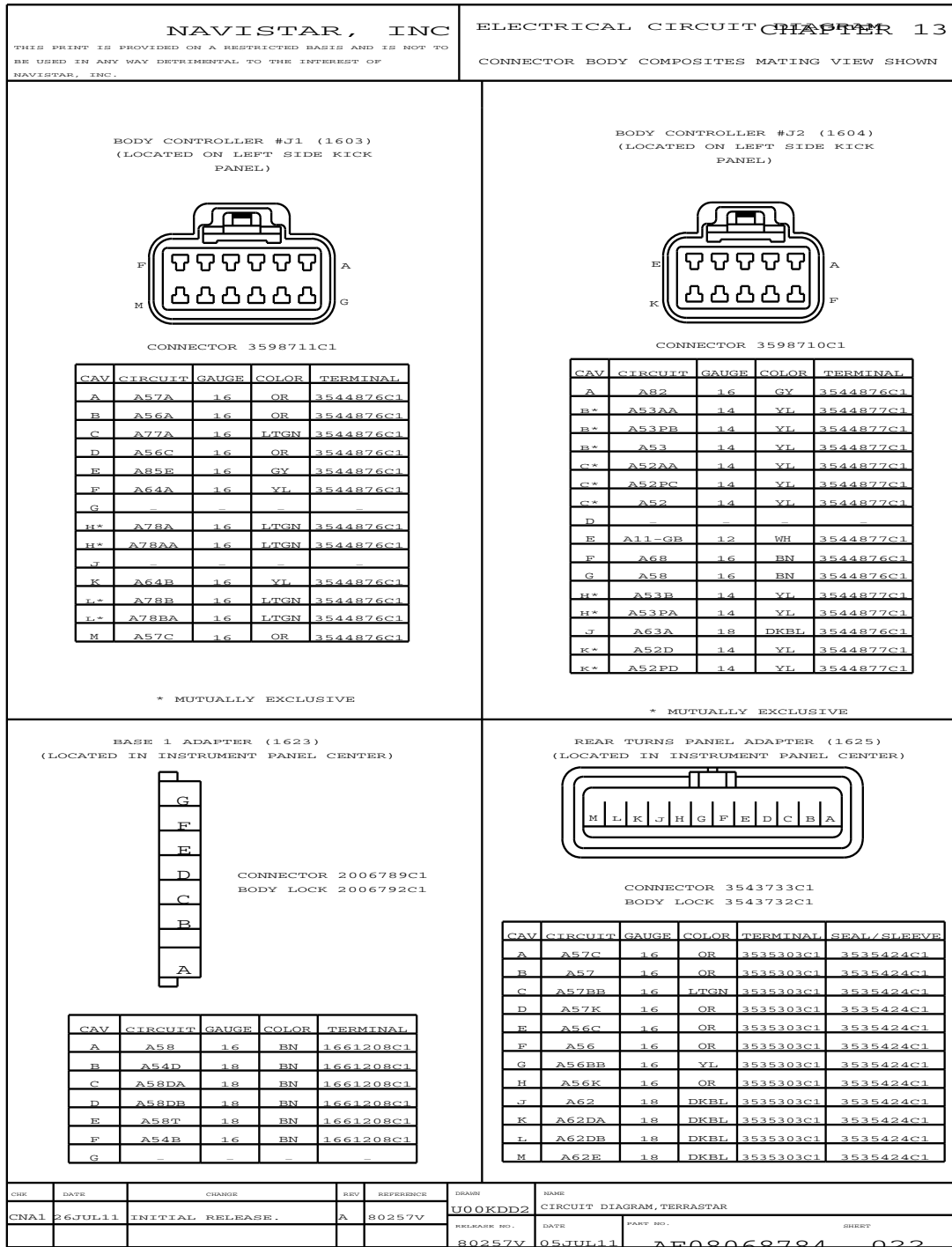

Figure 177 Connector Body Composites (1603 / 1604 / 1623 / 1625)

13.25. CONNECTOR BODY COMPOSITES (1626 / 1657 / 1650 / 1660 / 1661), P. 23

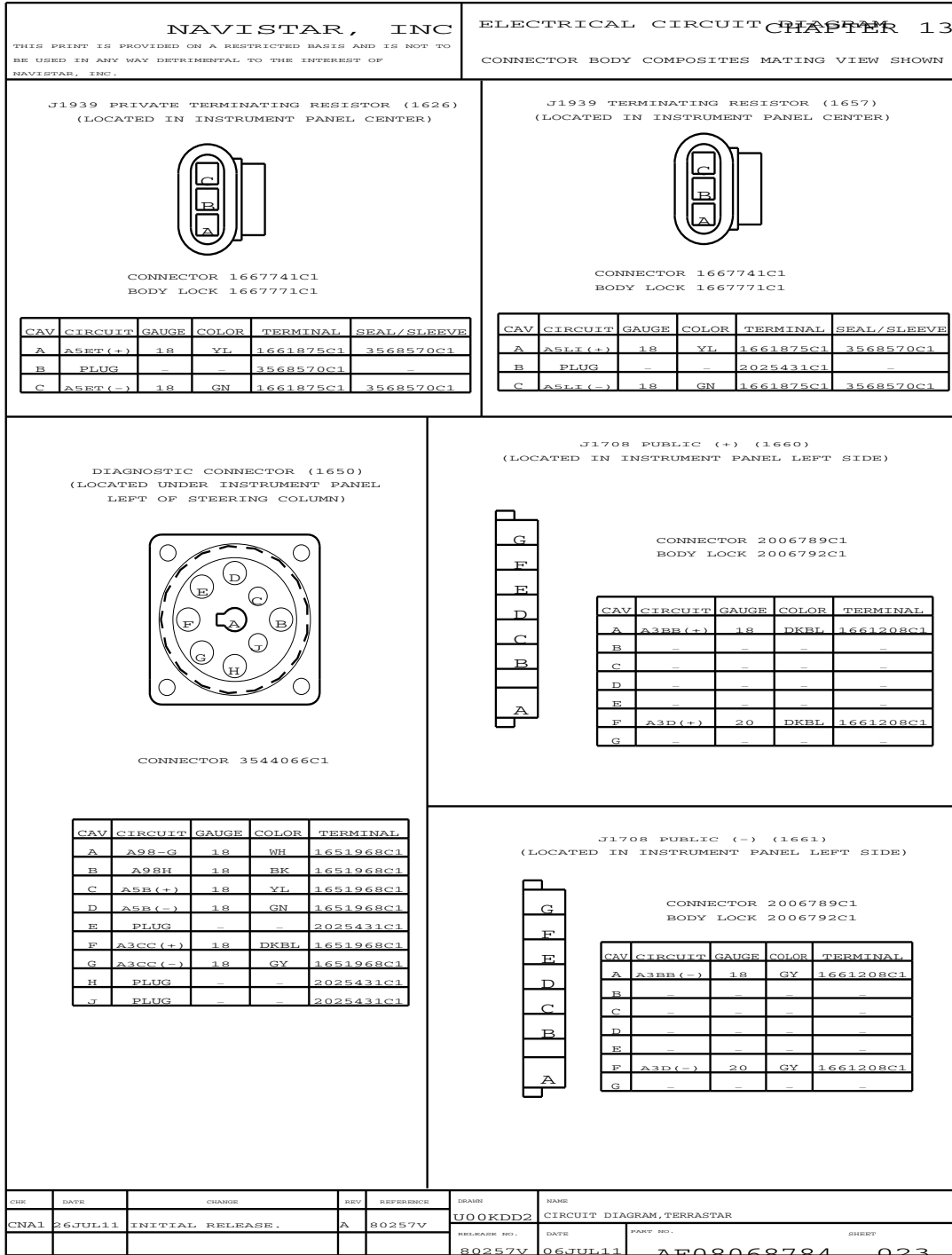

Figure 178 Connector Body Composites (1626 / 1657 / 1650 / 1660 / 1661)

13.26. CONNECTOR BODY COMPOSITES (1700), P. 24

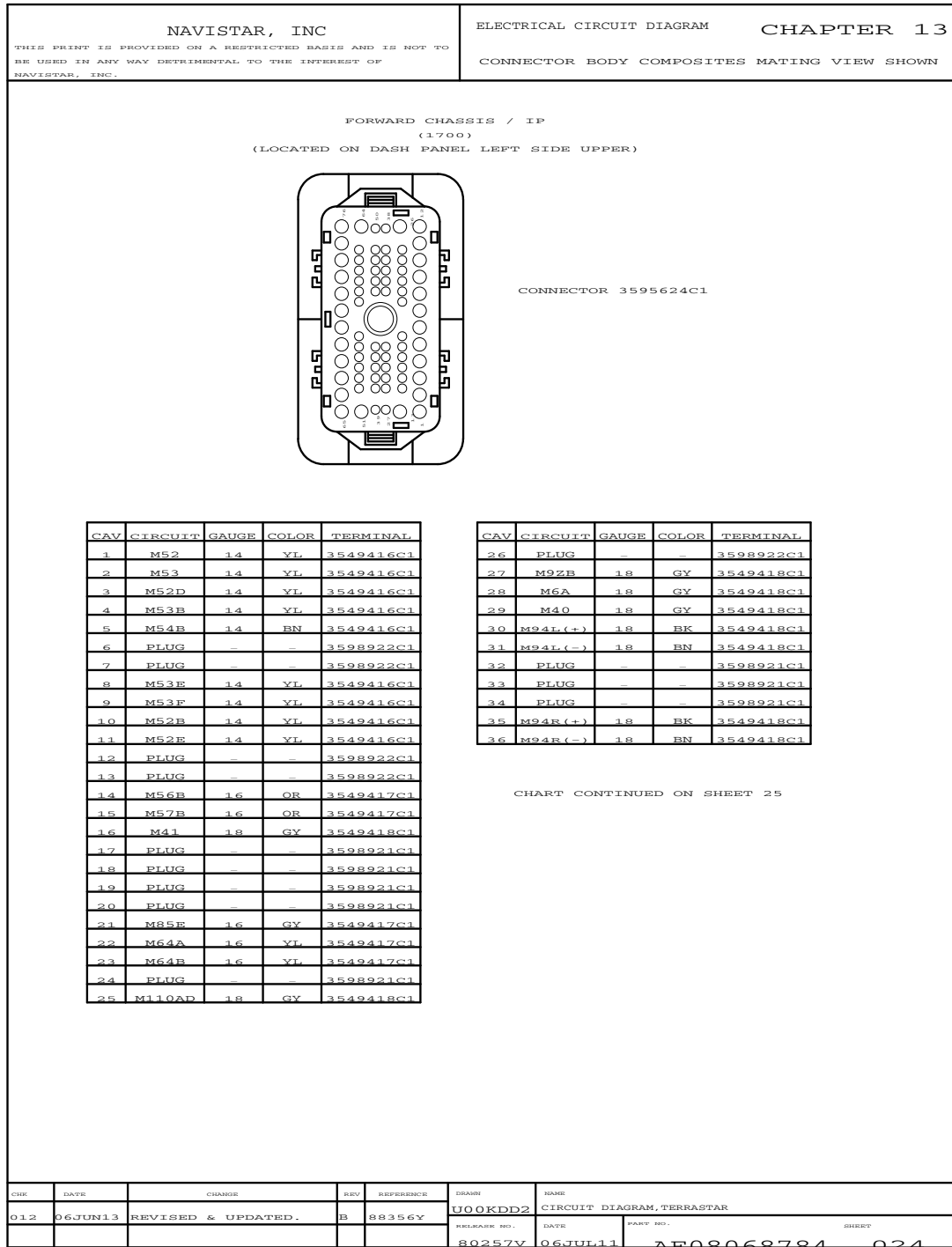

Figure 179 Connector Body Composites (1700)

13.27. CONNECTOR BODY COMPOSITES (1700), P. 25

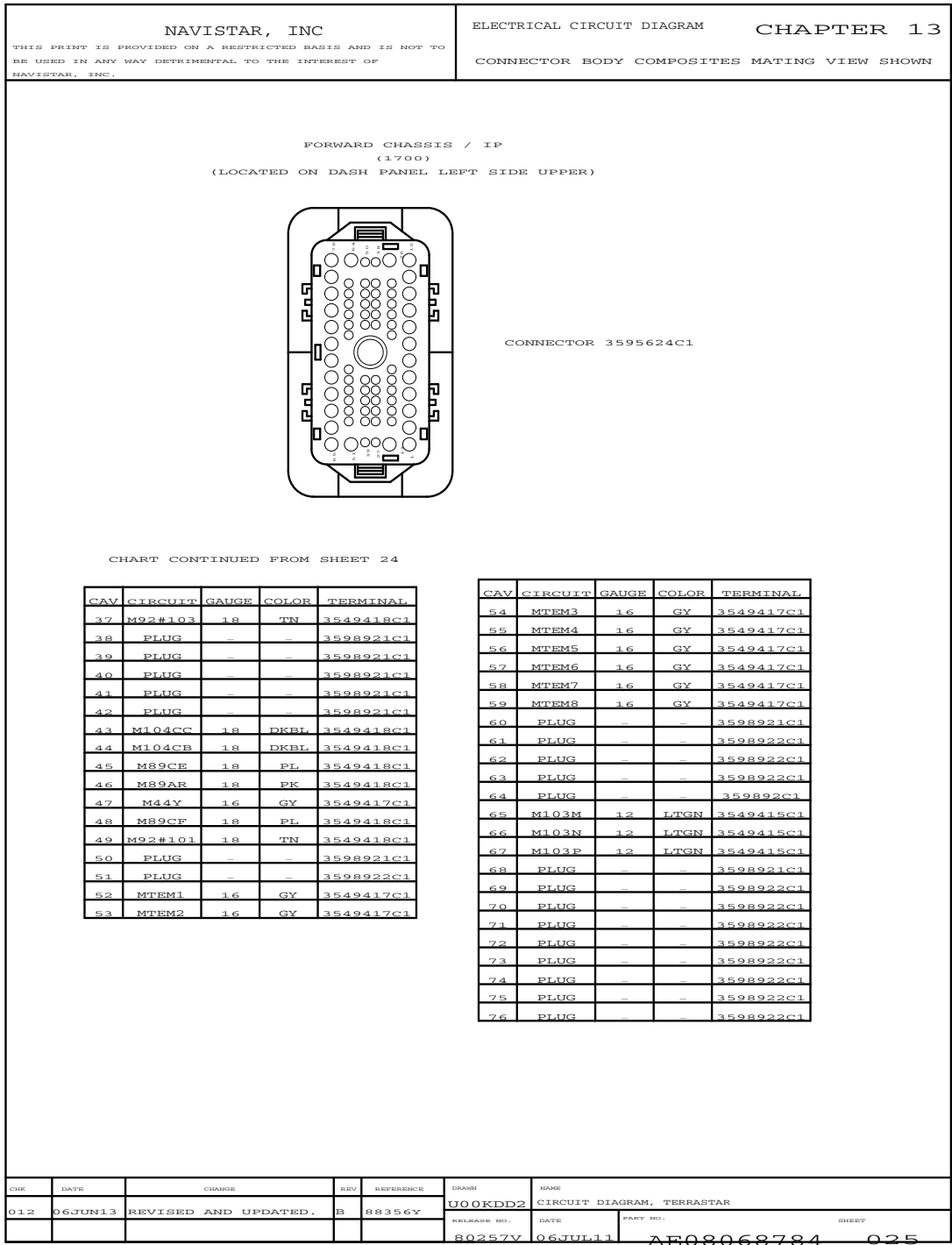

Figure 180 Connector Body Composites (1700)

13.28. CONNECTOR BODY COMPOSITES (1700), P. 26

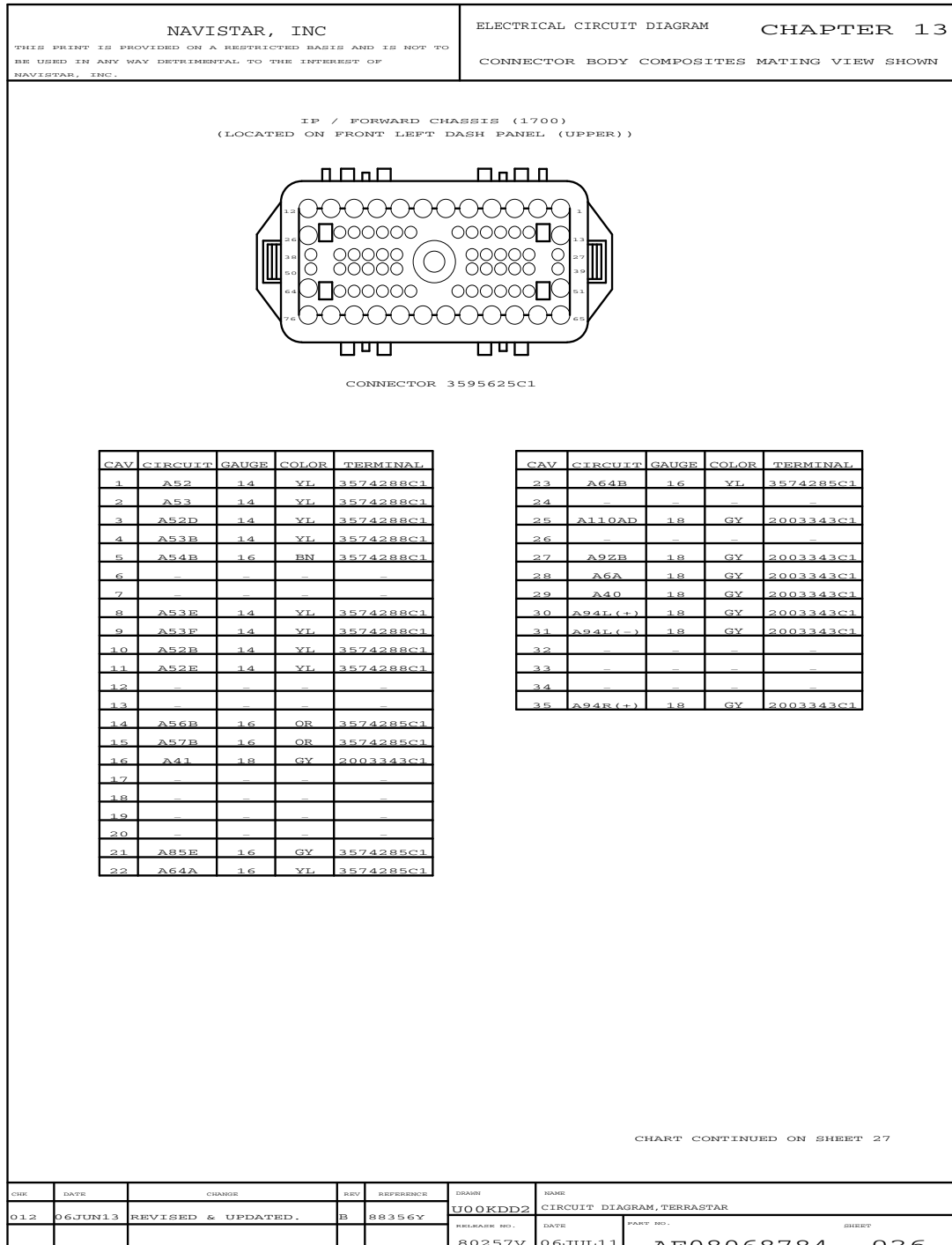

Figure 181 Connector Body Composites (1700)

13.29. CONNECTOR BODY COMPOSITES (1700), P. 27

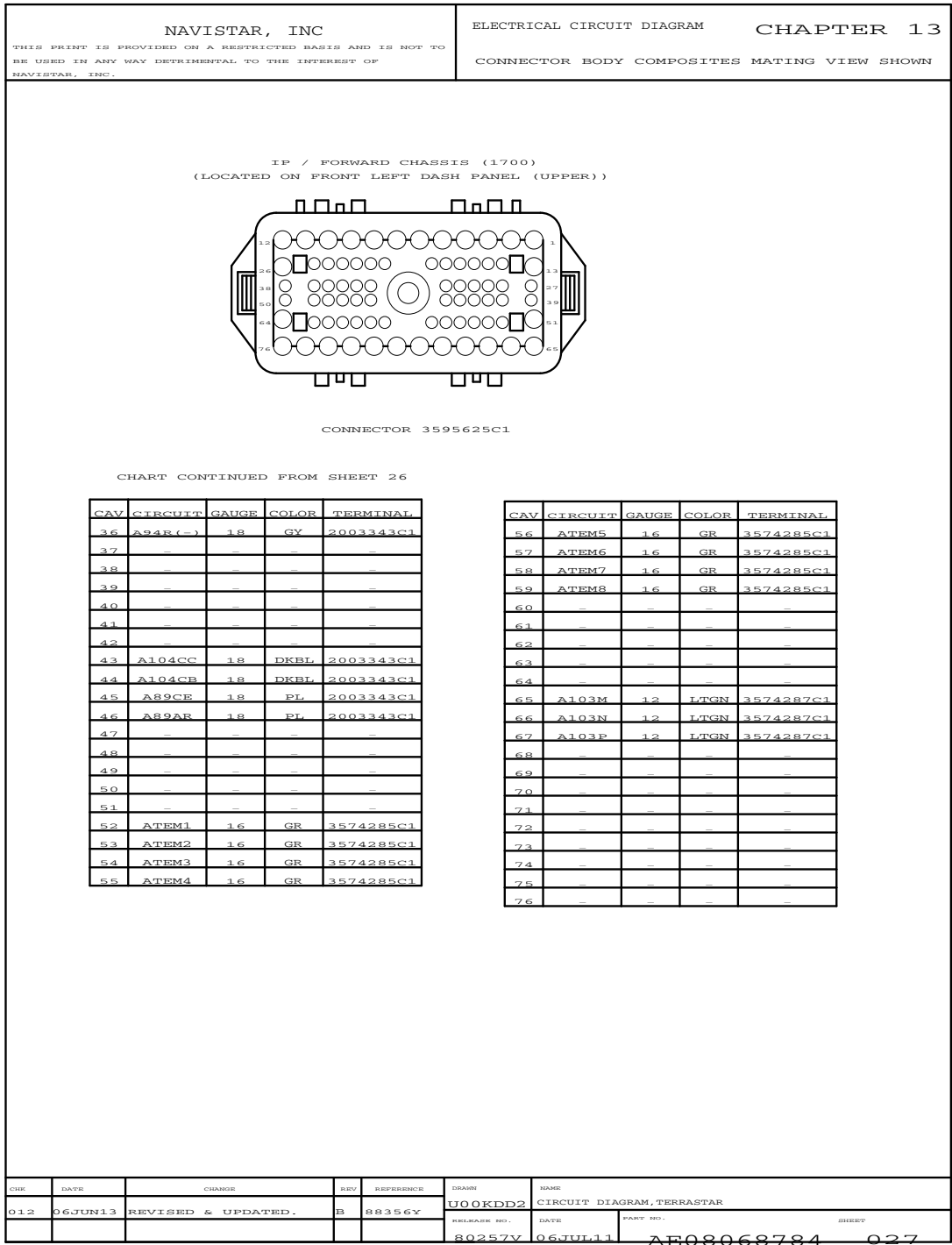

Figure 182 Connector Body Composites (1700)

13.30. CONNECTOR BODY COMPOSITES (1701), P. 28

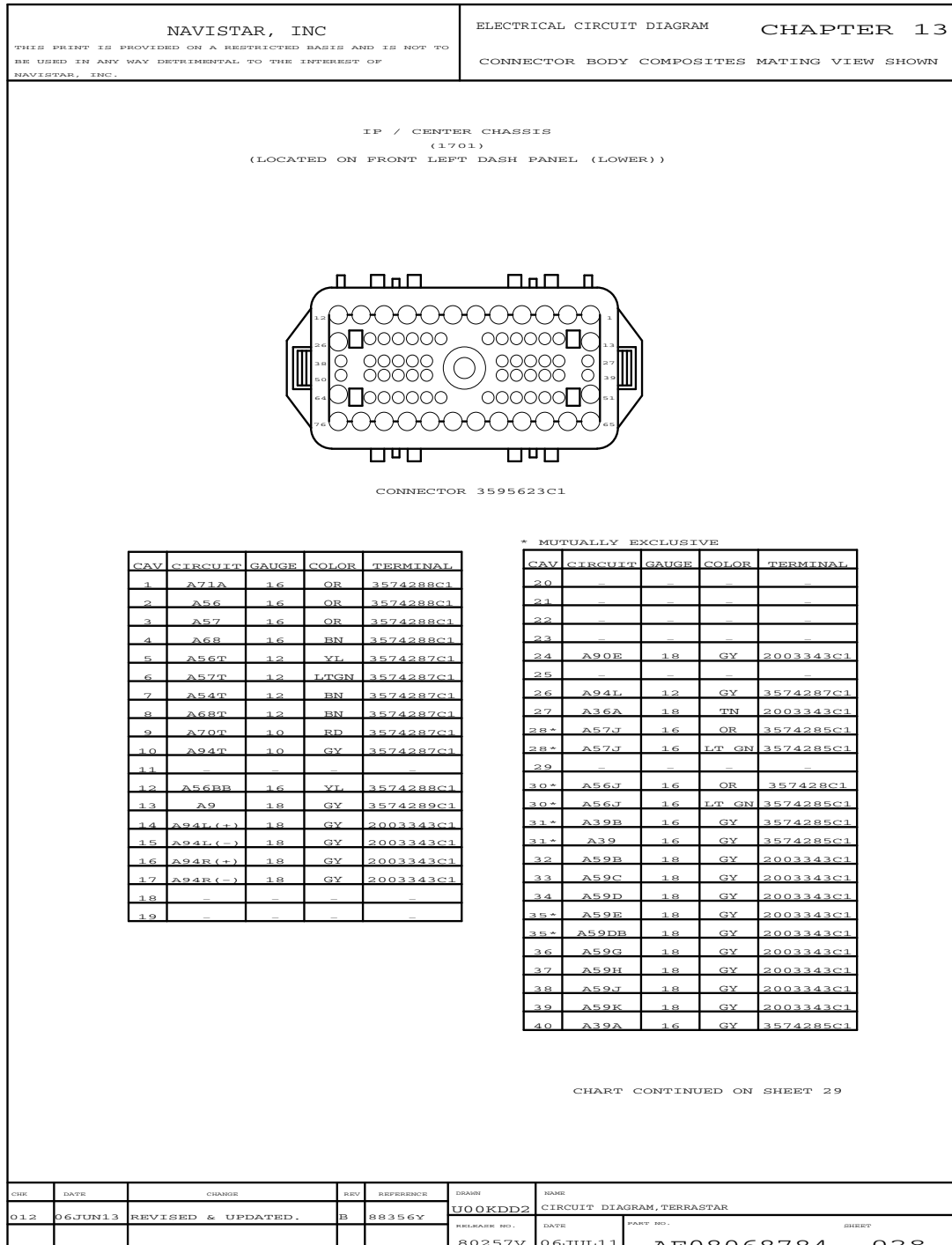

Figure 183 Connector Body Composites (1701)

13.31. CONNECTOR BODY COMPOSITES (1701), P. 29

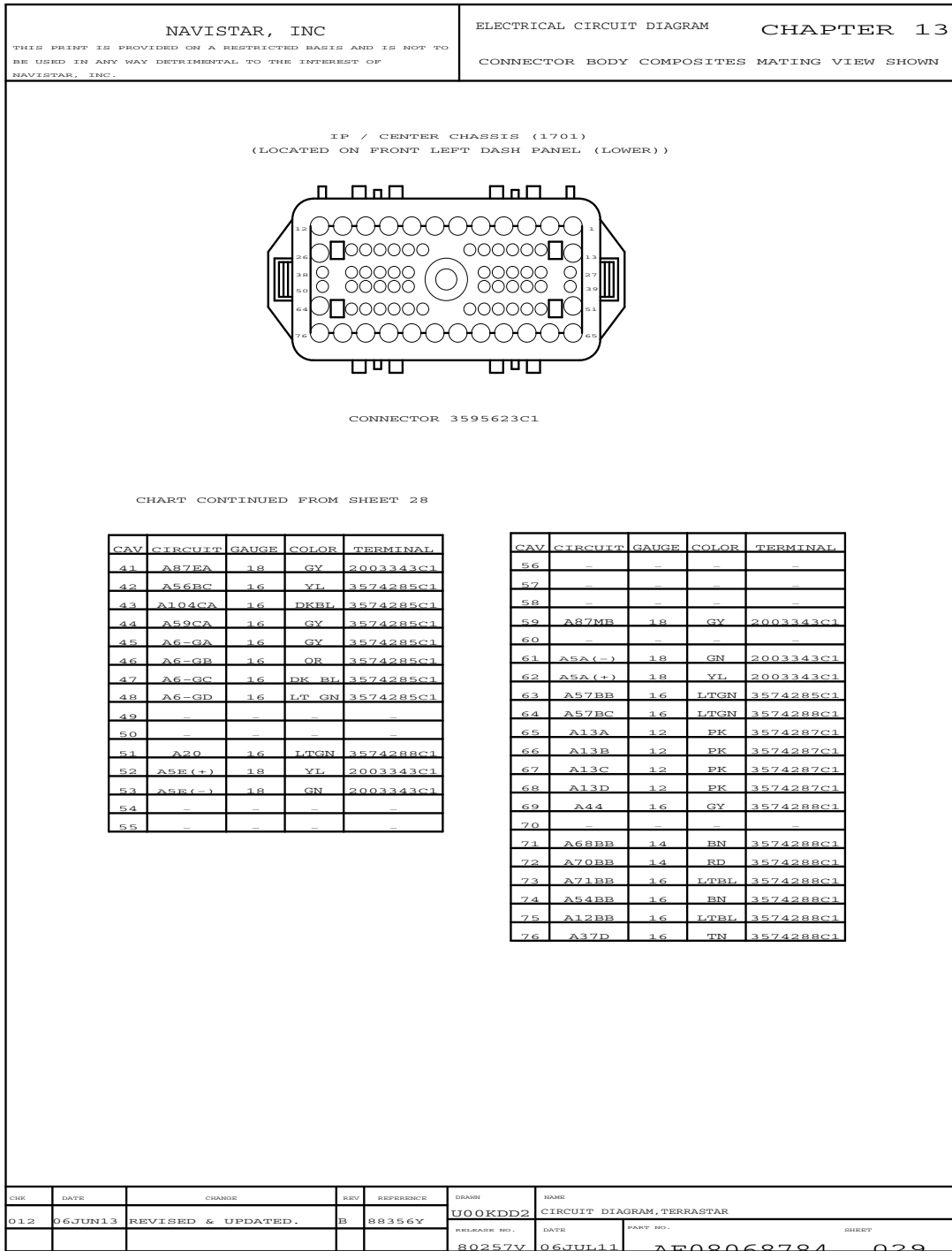

Figure 184 Connector Body Composites (1701)

13.32. CONNECTOR BODY COMPOSITES (1701F), P. 30

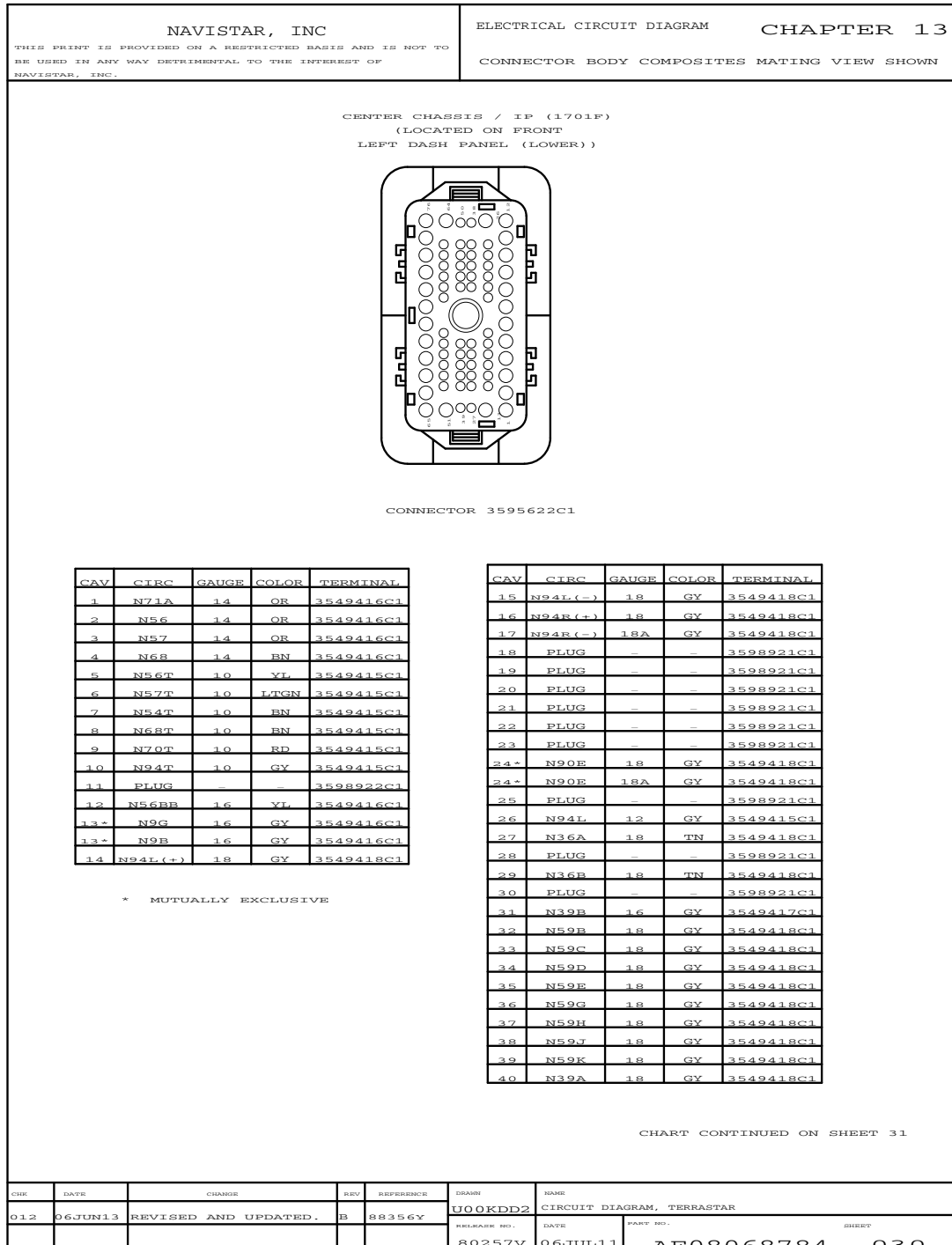

Figure 185 Connector Body Composites (1701F)

13.33. CONNECTOR BODY COMPOSITES (1701F), P. 31

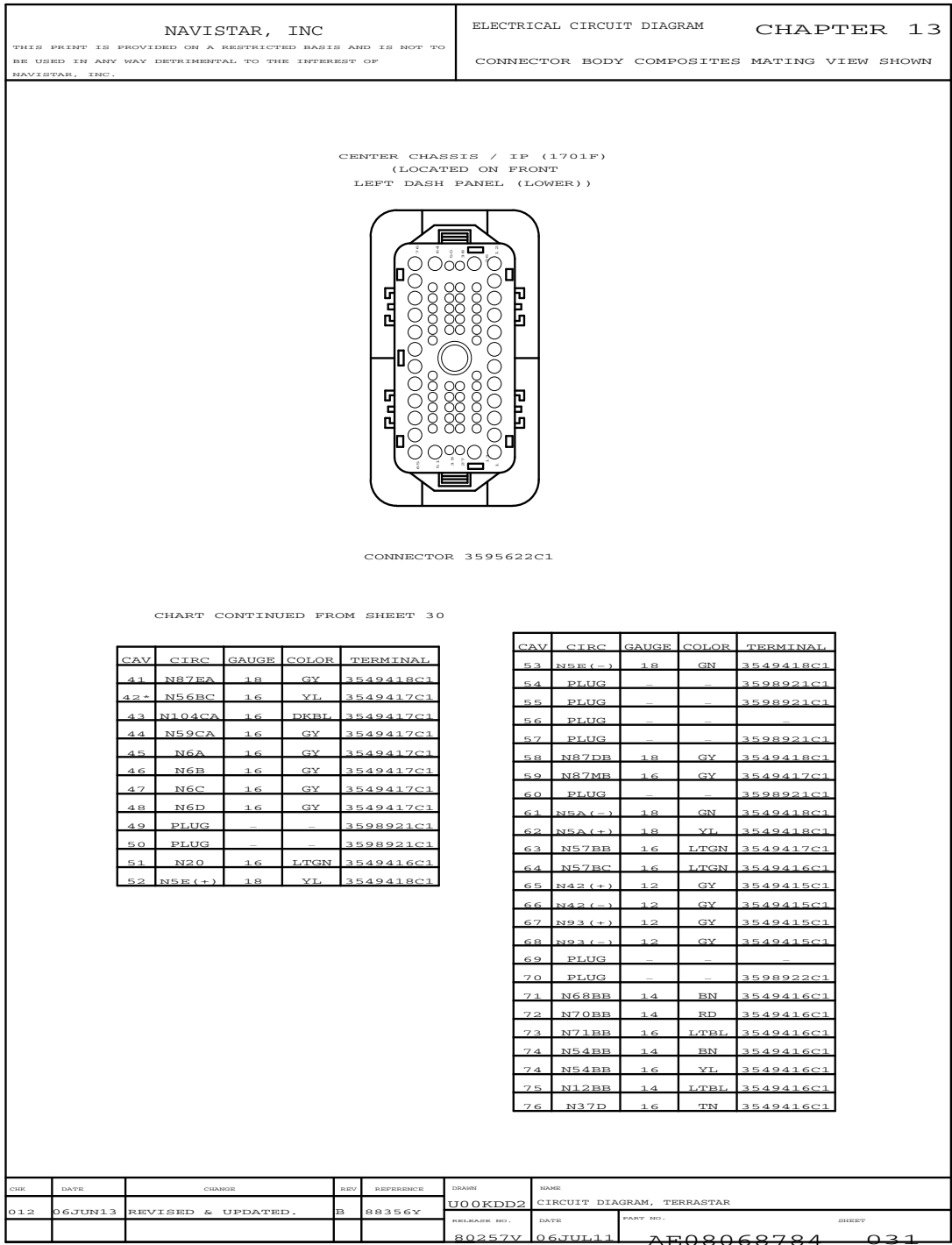

Figure 186 Connector Body Composites (1701F)

13.34. CONNECTOR BODY COMPOSITES (1702), P. 32

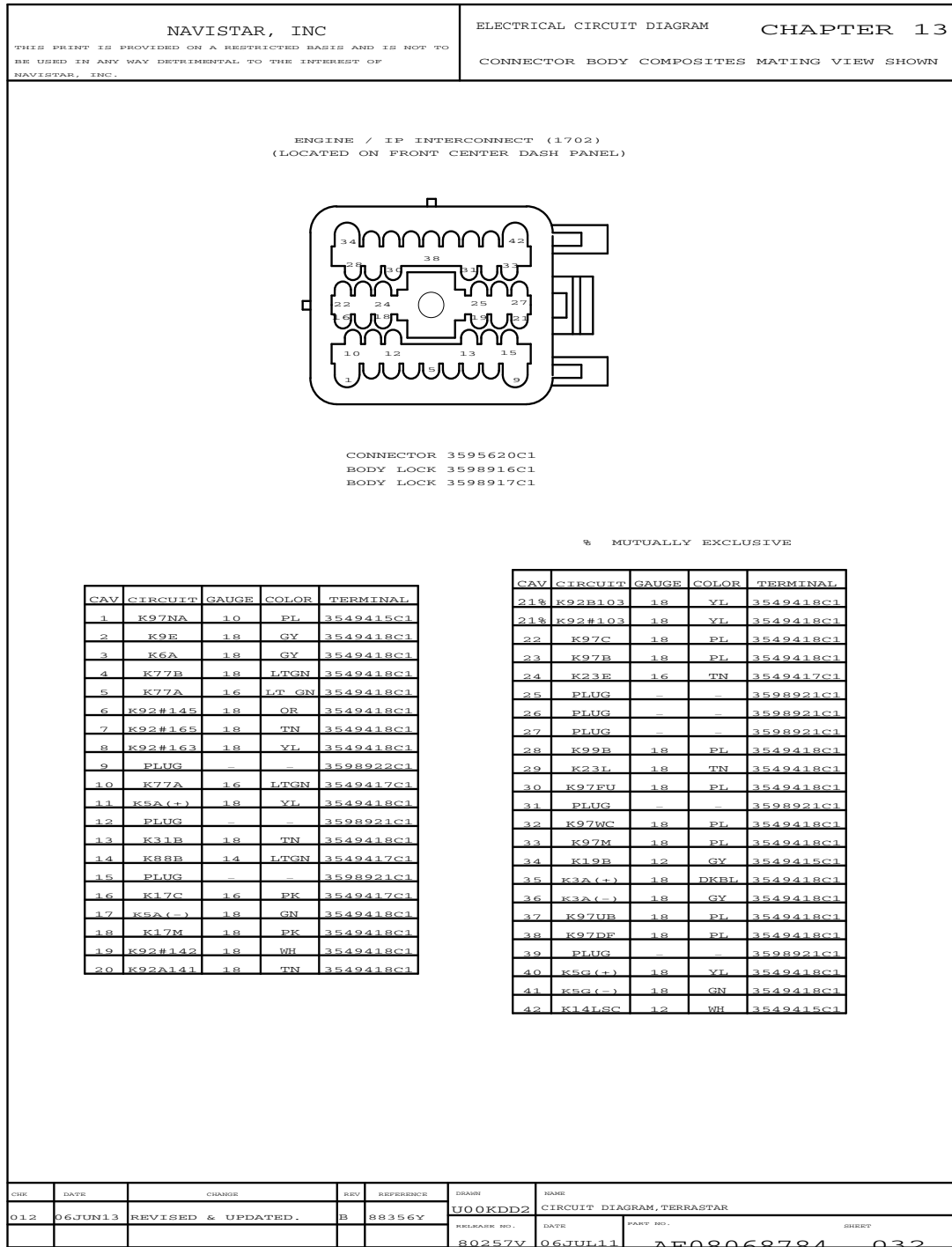

Figure 187 Connector Body Composites (1702)

13.35. CONNECTOR BODY COMPOSITES (1702), P. 33

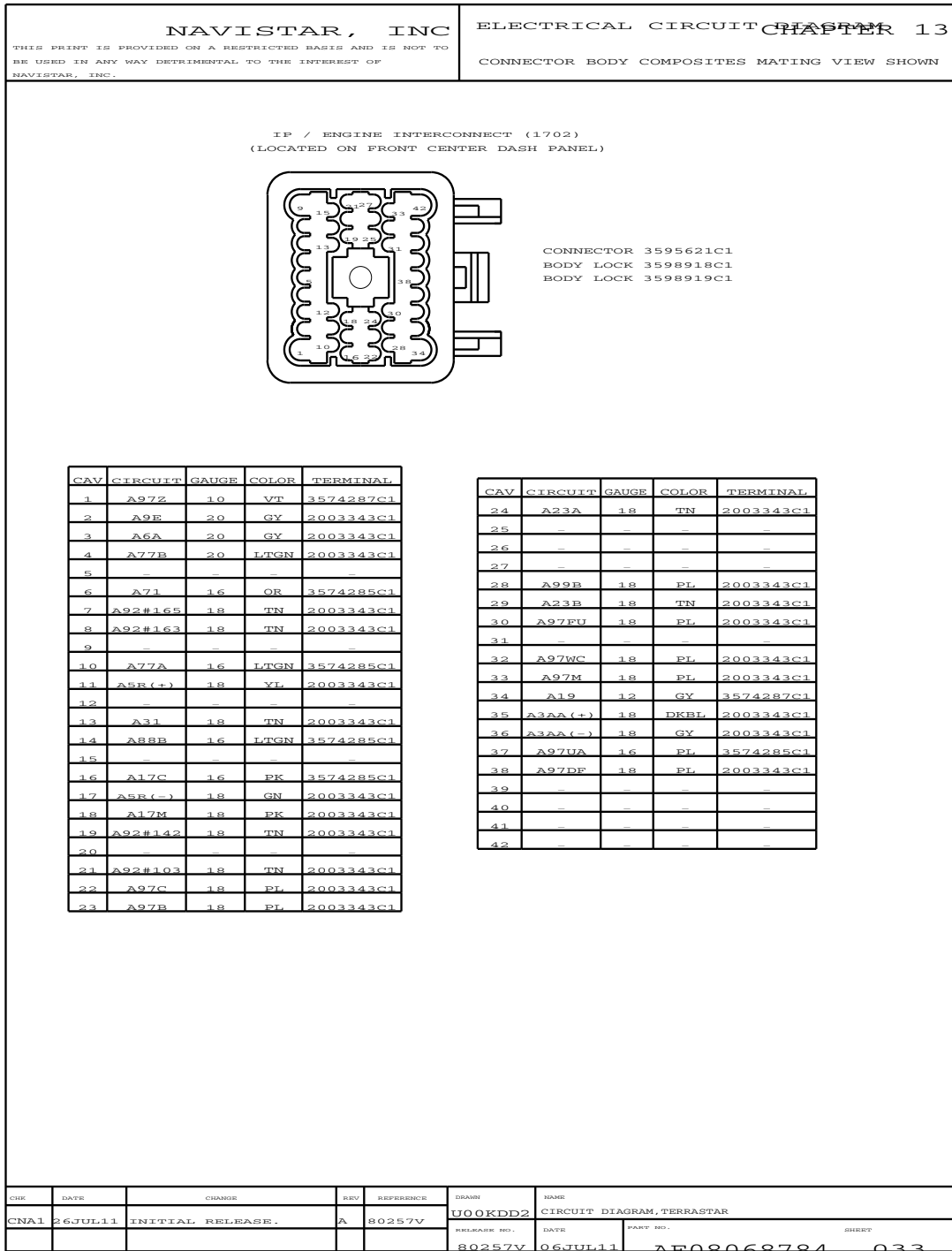

Figure 188 Connector Body Composites (1702)

13.36. CONNECTOR BODY COMPOSITES (1800 / 1800F), P. 34

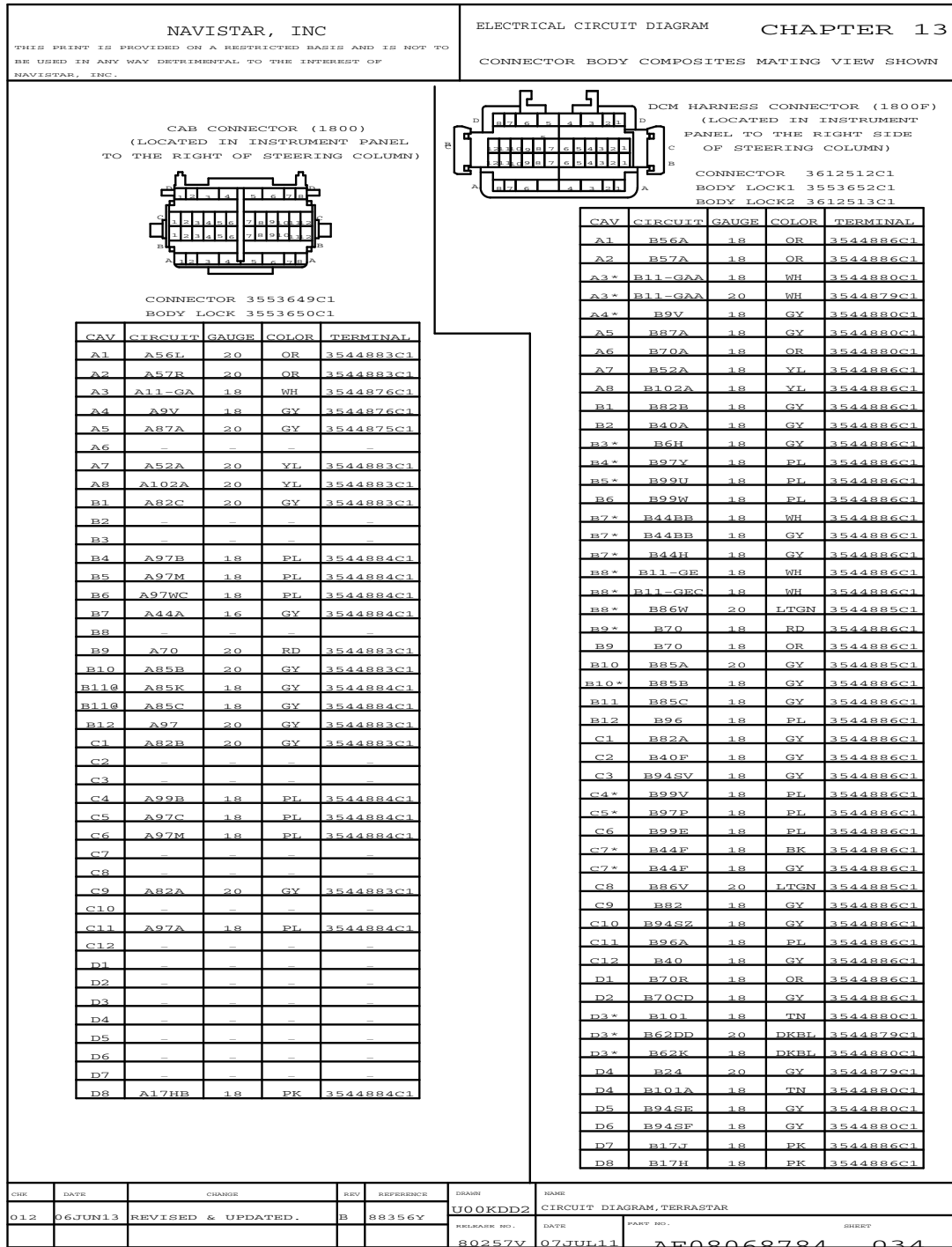

Figure 189 Connector Body Composites (1800 / 1800F)

13.37. CONNECTOR BODY COMPOSITES (1800FA / 1804 / 1807 / 1809 / 1810), P. 35

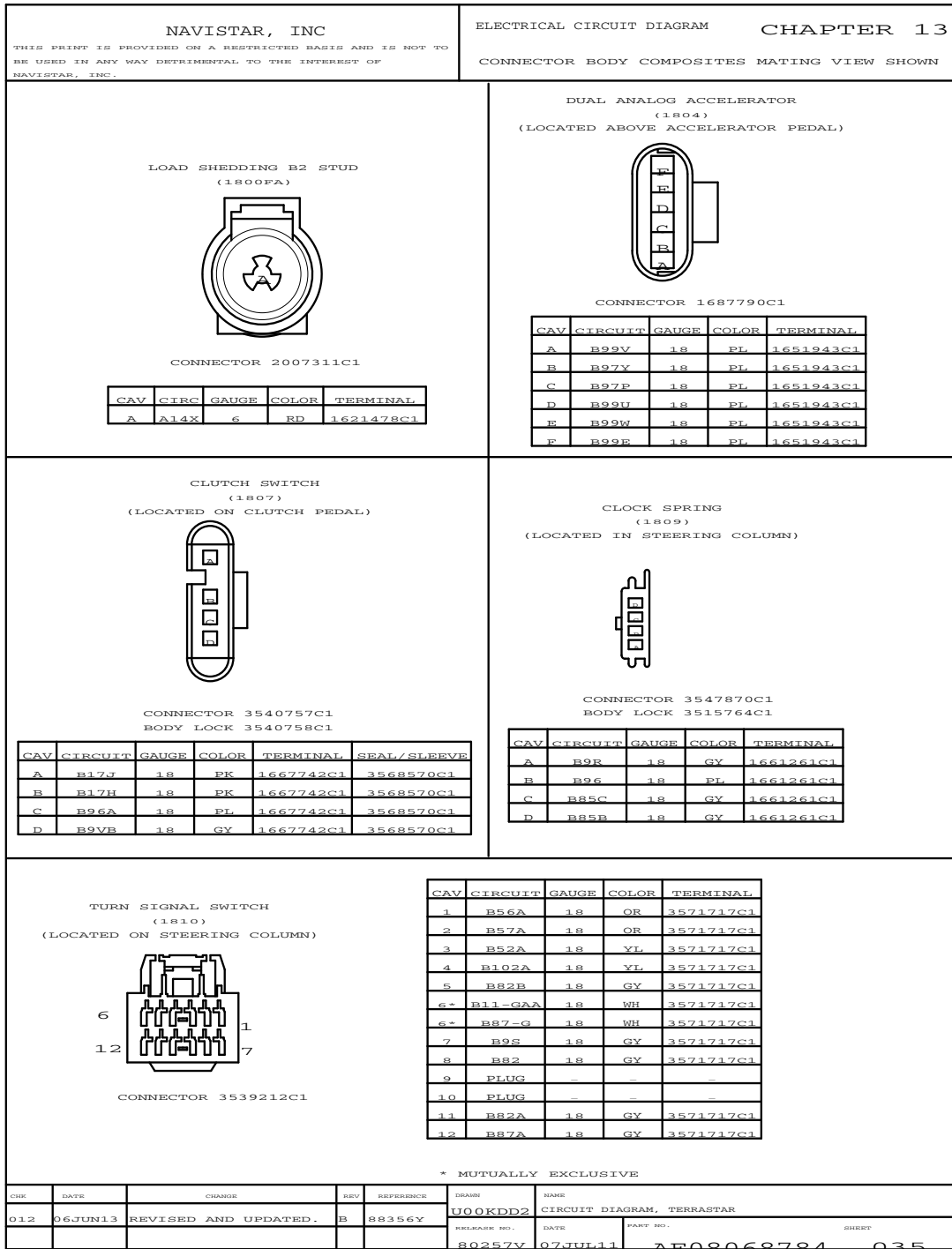

Figure 190 Connector Body Composites (1800FA / 1804 / 1807 / 1809 / 1810)

13.38. CONNECTOR BODY COMPOSITES (1814A / 1814B / 1815 / 1815A / 1828 / 1861 / 1872 / 1873), P. 36

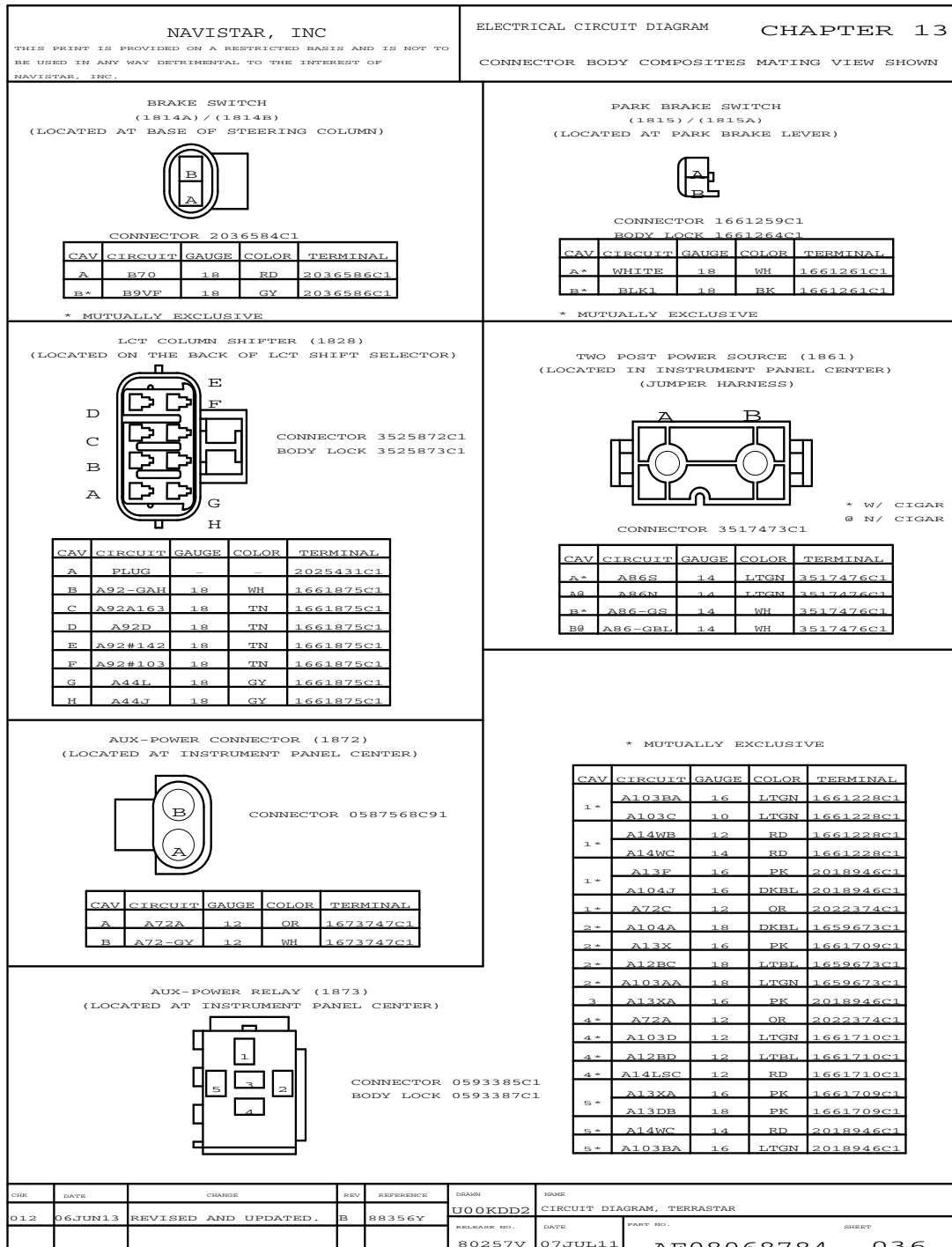

Figure 191 Connector Body Composites (1814A / 1814B / 1815 / 1815A / 1828 / 1861 / 1872 / 1873)

13.39. CONNECTOR BODY COMPOSITES (1873W / 1873X / 1873Y / 1873Z / 1900 / 1936M), P. 36A

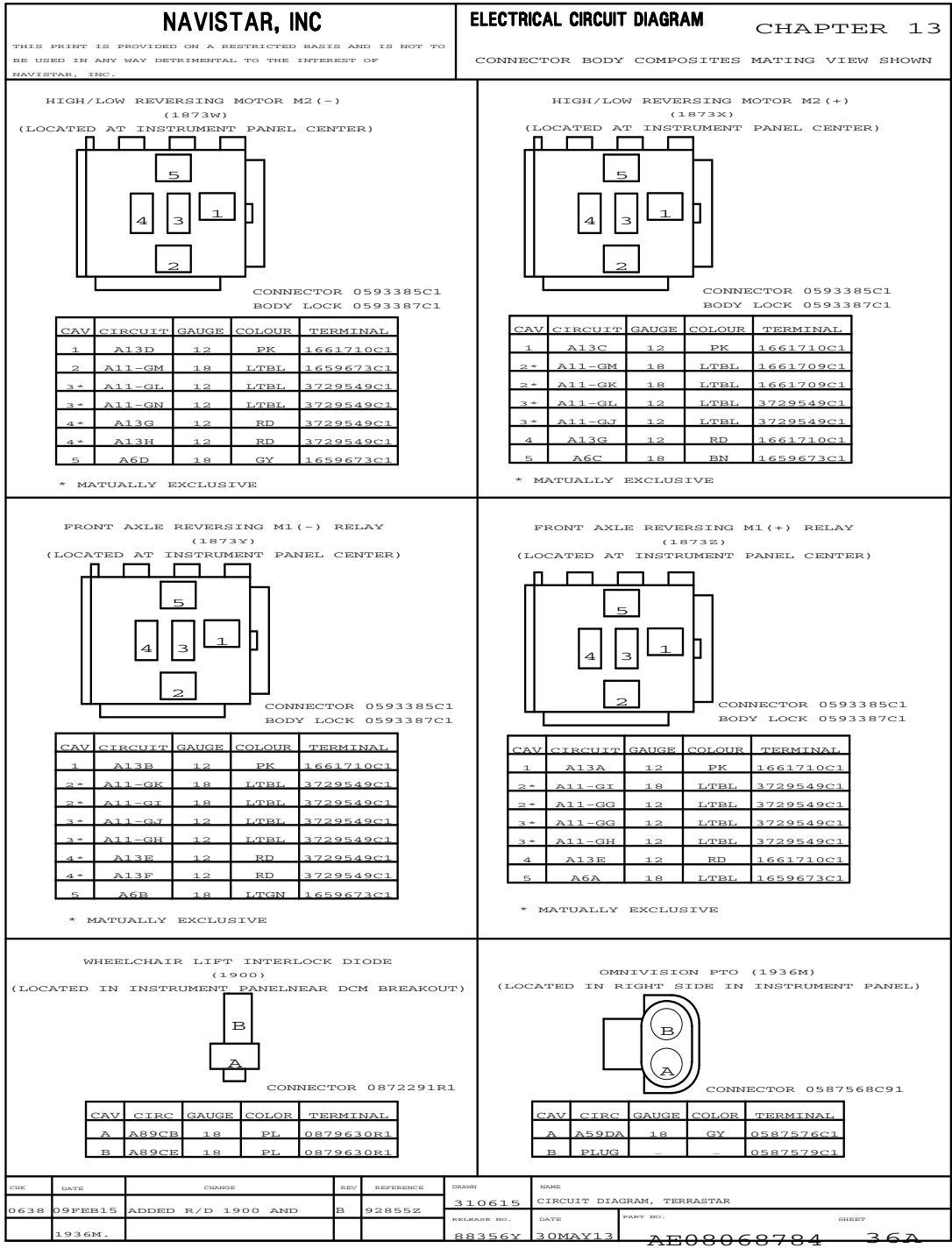

Figure 192 Connector Body Composites (1873W / 1873X / 1873Y / 1873Z / 1900 / 1936M)

13.40. CONNECTOR BODY COMPOSITES (1901 / 1912 / 1918 / 1927 / 1929 / 1935), P. 37

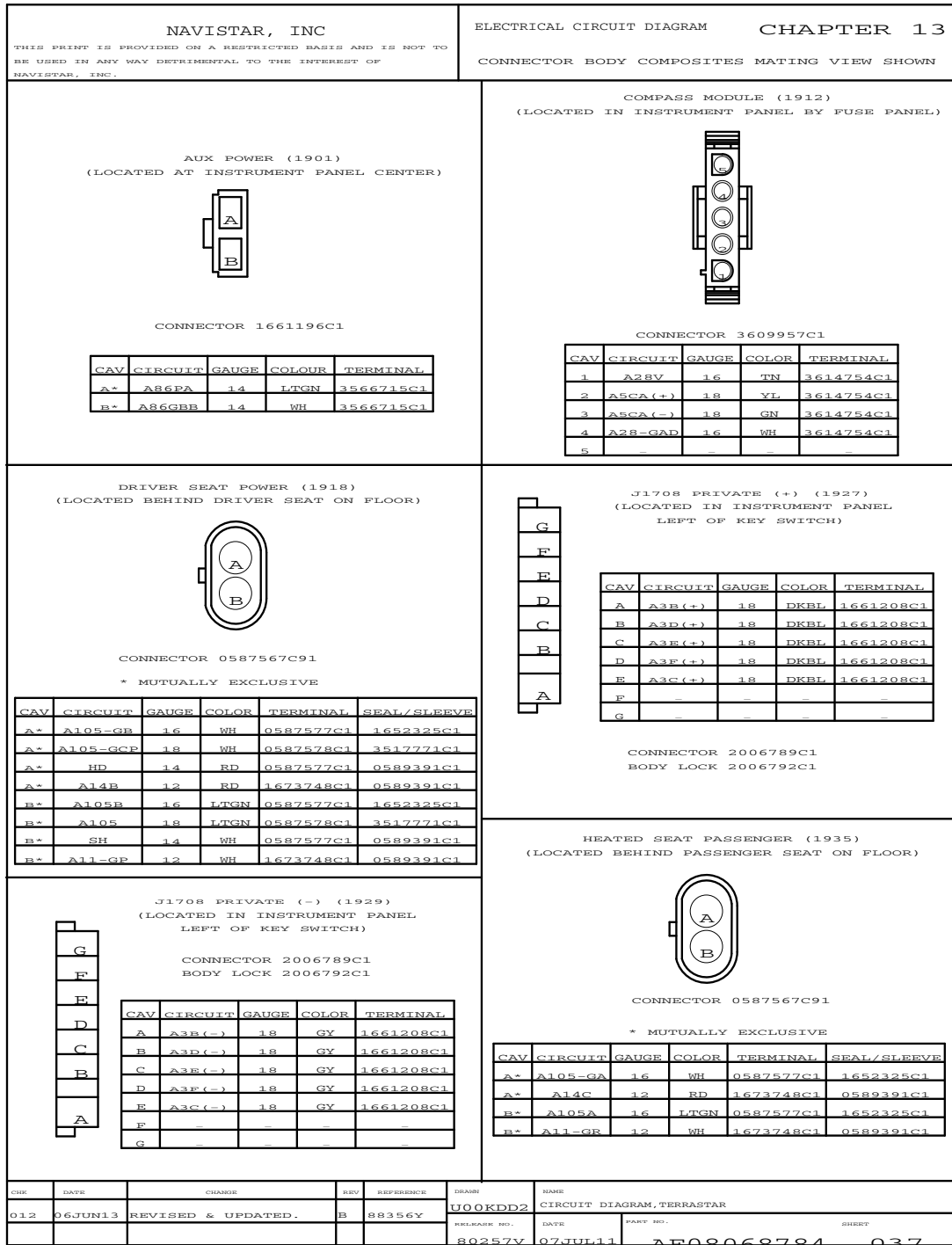

Figure 193 Connector Body Composites (1901 / 1912 / 1918 / 1927 / 1929 / 1935)

13.41. CONNECTOR BODY COMPOSITES (2000 / 2000F / 2002M / 2003M / 2004M / 2005M), P. 37A

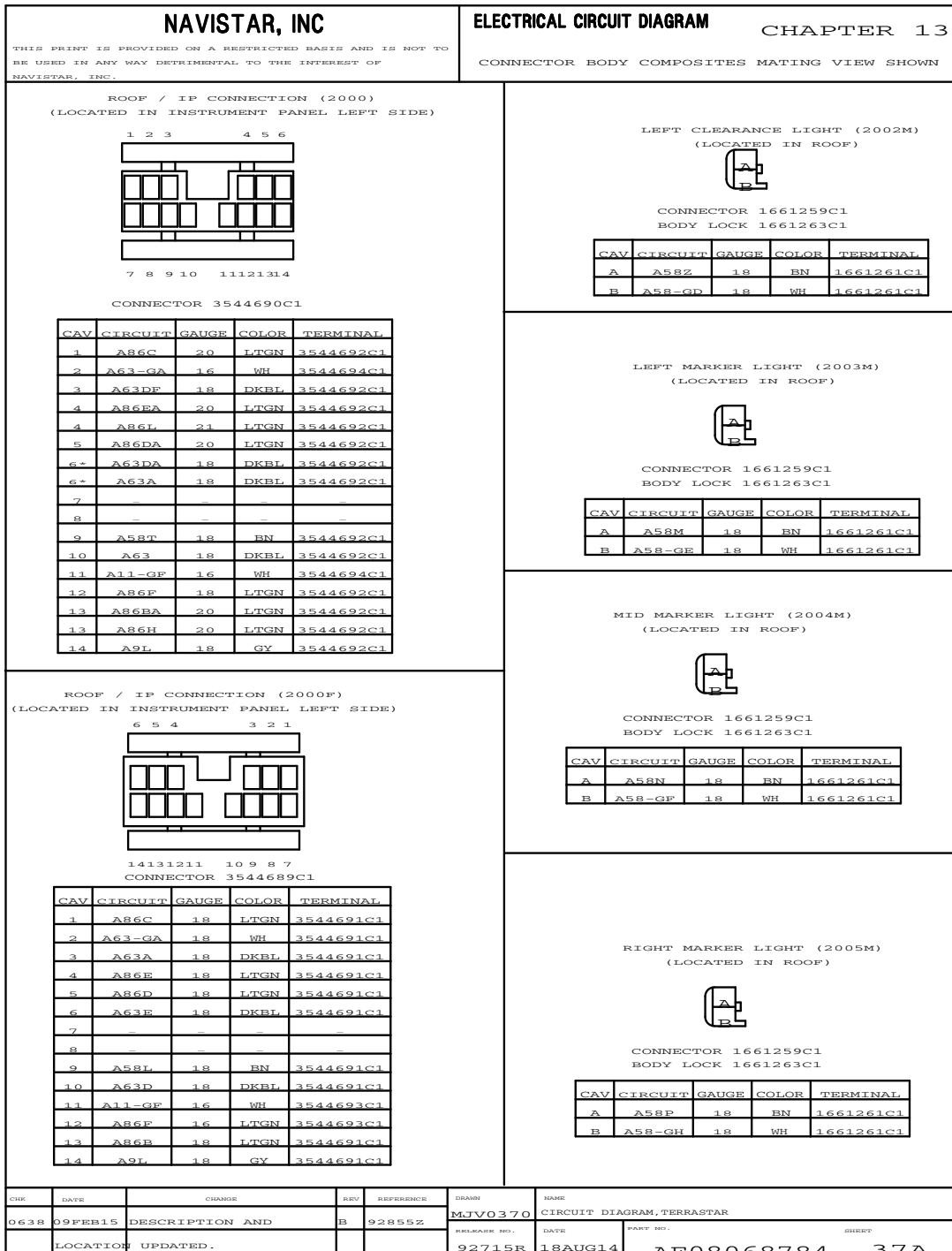

Figure 194 Connector Body Composites (2000 / 2000F / 2002M / 2003M / 2004M / 2005M)

13.42. CONNECTOR BODY COMPOSITES (2006M / 2115M / 2116F / 2117F / 2021 / 2301M), P. 37B





NAVISTAR, INC					ELECTRICAL CIRCUIT DIAGRAM					CHAPTER 13																																							
THIS PRINT IS PROVIDED ON A RESTRICTED BASIS AND IS NOT TO BE USED IN ANY WAY DETRIMENTAL TO THE INTEREST OF NAVISTAR, INC.					CONNECTOR BODY COMPOSITES MATING VIEW SHOWN																																												
IP / AUX ROOF (2006M) (LOCATED IN INSTRUMENT PANEL RIGHT SIDE)  CONNECTOR 1661259C1 BODY LOCK 1661263C1 <table border="1" style="width:100%; border-collapse: collapse; font-size: x-small;"> <thead> <tr><th>CAV</th><th>CIRCUIT</th><th>GAUGE</th><th>COLOR</th><th>TERMINAL</th></tr> </thead> <tbody> <tr><td>A</td><td>A58R</td><td>18</td><td>BN</td><td>1661261C1</td></tr> <tr><td>B</td><td>A58-GJ</td><td>18</td><td>WH</td><td>1661261C1</td></tr> </tbody> </table>					CAV	CIRCUIT	GAUGE	COLOR	TERMINAL	A	A58R	18	BN	1661261C1	B	A58-GJ	18	WH	1661261C1	IP / AUX ROOF (2115M) (LOCATED IN INSTRUMENT PANEL RIGHT SIDE)  CONNECTOR 1661889C1 BODY LOCK 1661890C1 <table border="1" style="width:100%; border-collapse: collapse; font-size: x-small;"> <thead> <tr><th>CAV</th><th>CIRCUIT</th><th>GAUGE</th><th>COLOR</th><th>TERMINAL</th></tr> </thead> <tbody> <tr><td>A</td><td>A63K</td><td>18</td><td>DKBL</td><td>1661261C1</td></tr> <tr><td>A</td><td>A63M</td><td>18</td><td>DKBL</td><td>1661261C1</td></tr> <tr><td>B</td><td>A63-GH</td><td>18</td><td>WH</td><td>1661261C1</td></tr> <tr><td>C</td><td>A63L</td><td>18</td><td>DKBL</td><td>1661261C1</td></tr> </tbody> </table>					CAV	CIRCUIT	GAUGE	COLOR	TERMINAL	A	A63K	18	DKBL	1661261C1	A	A63M	18	DKBL	1661261C1	B	A63-GH	18	WH	1661261C1	C	A63L	18	DKBL	1661261C1
CAV	CIRCUIT	GAUGE	COLOR	TERMINAL																																													
A	A58R	18	BN	1661261C1																																													
B	A58-GJ	18	WH	1661261C1																																													
CAV	CIRCUIT	GAUGE	COLOR	TERMINAL																																													
A	A63K	18	DKBL	1661261C1																																													
A	A63M	18	DKBL	1661261C1																																													
B	A63-GH	18	WH	1661261C1																																													
C	A63L	18	DKBL	1661261C1																																													
IP / AUX ROOF (2116F) (LOCATED IN INSTRUMENT PANEL RIGHT SIDE)  CONNECTOR 1661259C1 BODY LOCK 1661263C1 <table border="1" style="width:100%; border-collapse: collapse; font-size: x-small;"> <thead> <tr><th>CAV</th><th>CIRCUIT</th><th>GAUGE</th><th>COLOR</th><th>TERMINAL</th></tr> </thead> <tbody> <tr><td>A</td><td>A63P</td><td>18</td><td>DKBL</td><td>1661261C1</td></tr> <tr><td>B</td><td>A63-GJ</td><td>18</td><td>DKBL</td><td>1661261C1</td></tr> </tbody> </table>					CAV	CIRCUIT	GAUGE	COLOR	TERMINAL	A	A63P	18	DKBL	1661261C1	B	A63-GJ	18	DKBL	1661261C1	IP / AUX ROOF (2117F) (LOCATED IN INSTRUMENT PANEL RIGHT SIDE)  CONNECTOR 1661259C1 BODY LOCK 1661263C1 <table border="1" style="width:100%; border-collapse: collapse; font-size: x-small;"> <thead> <tr><th>CAV</th><th>CIRCUIT</th><th>GAUGE</th><th>COLOR</th><th>TERMINAL</th></tr> </thead> <tbody> <tr><td>A</td><td>A63R</td><td>18</td><td>DK BL</td><td>1661261C1</td></tr> <tr><td>B</td><td>A63-GK</td><td>18</td><td>DK BL</td><td>1661261C1</td></tr> </tbody> </table>					CAV	CIRCUIT	GAUGE	COLOR	TERMINAL	A	A63R	18	DK BL	1661261C1	B	A63-GK	18	DK BL	1661261C1										
CAV	CIRCUIT	GAUGE	COLOR	TERMINAL																																													
A	A63P	18	DKBL	1661261C1																																													
B	A63-GJ	18	DKBL	1661261C1																																													
CAV	CIRCUIT	GAUGE	COLOR	TERMINAL																																													
A	A63R	18	DK BL	1661261C1																																													
B	A63-GK	18	DK BL	1661261C1																																													
IP / AUX ROOF (2021) (LOCATED IN INSTRUMENT PANEL RIGHT SIDE)  CONNECTOR 3554817C1 BODY LOCK 3554820C1 <table border="1" style="width:100%; border-collapse: collapse; font-size: x-small;"> <thead> <tr><th>CAV</th><th>CIRCUIT</th><th>GAUGE</th><th>COLOR</th><th>TERMINAL</th></tr> </thead> <tbody> <tr><td>*A</td><td>A12U</td><td>16</td><td>LTBL</td><td>3534165C1</td></tr> <tr><td>⊙A</td><td>A58C</td><td>18</td><td>BN</td><td>3534164C1</td></tr> <tr><td>*B</td><td>A12-GB</td><td>16</td><td>WH</td><td>3534165C1</td></tr> <tr><td>⊙B</td><td>A58-GBM</td><td>18</td><td>WH</td><td>3534164C1</td></tr> </tbody> </table> <p style="font-size: x-small; margin-top: 10px;">* - W/ ROOF AUXILLARY LOAD ⊙ - W/ AIR SHILD</p>					CAV	CIRCUIT	GAUGE	COLOR	TERMINAL	*A	A12U	16	LTBL	3534165C1	⊙A	A58C	18	BN	3534164C1	*B	A12-GB	16	WH	3534165C1	⊙B	A58-GBM	18	WH	3534164C1	RIGHT REAR SPEAKER (2301M) (LOCATED IN REAR PANEL)  CONNECTOR 3535769C1 BODY LOCK 1661263C1 <table border="1" style="width:100%; border-collapse: collapse; font-size: x-small;"> <thead> <tr><th>CAV</th><th>CIRC</th><th>GAUGE</th><th>COLOR</th><th>TERMINAL</th></tr> </thead> <tbody> <tr><td>A</td><td>D86D</td><td>18</td><td>LT GN</td><td>1661261C1</td></tr> <tr><td>B</td><td>D86E</td><td>18</td><td>LT GN</td><td>1661261C1</td></tr> </tbody> </table>					CAV	CIRC	GAUGE	COLOR	TERMINAL	A	D86D	18	LT GN	1661261C1	B	D86E	18	LT GN	1661261C1
CAV	CIRCUIT	GAUGE	COLOR	TERMINAL																																													
*A	A12U	16	LTBL	3534165C1																																													
⊙A	A58C	18	BN	3534164C1																																													
*B	A12-GB	16	WH	3534165C1																																													
⊙B	A58-GBM	18	WH	3534164C1																																													
CAV	CIRC	GAUGE	COLOR	TERMINAL																																													
A	D86D	18	LT GN	1661261C1																																													
B	D86E	18	LT GN	1661261C1																																													
CHG	DATE	CHANGE	REV	REFERENCE	DRWN	NAME																																											
0638	09FEB15	REVISED AND REDRAWN.	B	92855Z	MJVO370	CIRCUIT DIAGRAM, TERRASTAR																																											
RELEASE NO.		DATE		PART NO.		SHEET																																											
92715R		18AUG14		AE08068784		37B																																											

Figure 195 Connector Body Composites (2006M / 2115M / 2116F / 2117F / 2021 / 2301M)

13.43. CONNECTOR BODY COMPOSITES (2302M / 2304M / 2305M / 2502M), P. 37C



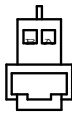

NAVISTAR, INC					ELECTRICAL CIRCUIT DIAGRAM					CHAPTER 13																																												
THIS PRINT IS PROVIDED ON A RESTRICTED BASIS AND IS NOT TO BE USED IN ANY WAY DETRIMENTAL TO THE INTEREST OF NAVISTAR, INC.										CONNECTOR BODY COMPOSITES MATING VIEW SHOWN																																												
<p>LEFT REAR SPEAKER (2302M) (LOCATED IN REAR PANEL)</p>  <p>CONNECTOR 3535769C1 BODY LOCK 1661263C1</p> <table border="1" style="width:100%; border-collapse: collapse; font-size: x-small;"> <thead> <tr> <th>CAV</th> <th>CIRC</th> <th>GAUGE</th> <th>COLOR</th> <th>TERMINAL</th> </tr> </thead> <tbody> <tr> <td>A</td> <td>D86B</td> <td>18</td> <td>LT GN</td> <td>1661261C1</td> </tr> <tr> <td>B</td> <td>D86C</td> <td>18</td> <td>LT GN</td> <td>1661261C1</td> </tr> </tbody> </table>															CAV	CIRC	GAUGE	COLOR	TERMINAL	A	D86B	18	LT GN	1661261C1	B	D86C	18	LT GN	1661261C1																									
CAV	CIRC	GAUGE	COLOR	TERMINAL																																																		
A	D86B	18	LT GN	1661261C1																																																		
B	D86C	18	LT GN	1661261C1																																																		
<p>RIGHT CONSOLE SPEAKER (2304M) (LOCATED IN CONSOLE)</p>  <p>CONNECTOR 3535769C1 BODY LOCK 1661263C1</p> <table border="1" style="width:100%; border-collapse: collapse; font-size: x-small;"> <thead> <tr> <th>CAV</th> <th>CIRCUIT</th> <th>GAUGE</th> <th>COLOR</th> <th>TERMINAL</th> </tr> </thead> <tbody> <tr> <td>A</td> <td>C86K</td> <td>18</td> <td>LT GN</td> <td>1661261C1</td> </tr> <tr> <td>B</td> <td>C86L</td> <td>18</td> <td>LT GN</td> <td>1661261C1</td> </tr> </tbody> </table>															CAV	CIRCUIT	GAUGE	COLOR	TERMINAL	A	C86K	18	LT GN	1661261C1	B	C86L	18	LT GN	1661261C1																									
CAV	CIRCUIT	GAUGE	COLOR	TERMINAL																																																		
A	C86K	18	LT GN	1661261C1																																																		
B	C86L	18	LT GN	1661261C1																																																		
<p>LEFT CONSOLE SPEAKER (2305M) (LOCATED IN CONSOLE)</p>  <p>CONNECTOR 3535769C1 BODY LOCK 1661263C1</p> <table border="1" style="width:100%; border-collapse: collapse; font-size: x-small;"> <thead> <tr> <th>CAV</th> <th>CIRCUIT</th> <th>GAUGE</th> <th>COLOR</th> <th>TERMINAL</th> </tr> </thead> <tbody> <tr> <td>A</td> <td>C86H</td> <td>18</td> <td>LT GN</td> <td>1661261C1</td> </tr> <tr> <td>B</td> <td>C86J</td> <td>18</td> <td>LT GN</td> <td>1661261C1</td> </tr> </tbody> </table>															CAV	CIRCUIT	GAUGE	COLOR	TERMINAL	A	C86H	18	LT GN	1661261C1	B	C86J	18	LT GN	1661261C1																									
CAV	CIRCUIT	GAUGE	COLOR	TERMINAL																																																		
A	C86H	18	LT GN	1661261C1																																																		
B	C86J	18	LT GN	1661261C1																																																		
<p>CONSOLE ROOF STANDARD (2502M) (LOCATED IN ROOF)</p>  <p>CONNECTOR 1667305C1 BODY LOCK 1661263C1</p> <table border="1" style="width:100%; border-collapse: collapse; font-size: x-small;"> <thead> <tr> <th>CAV</th> <th>CIRCUIT</th> <th>GAUGE</th> <th>COLOR</th> <th>TERMINAL</th> </tr> </thead> <tbody> <tr> <td>A</td> <td>D86F</td> <td>16</td> <td>LT GN</td> <td>1661261C1</td> </tr> <tr> <td>B</td> <td>D11-GE</td> <td>16</td> <td>WH</td> <td>1661261C1</td> </tr> <tr> <td>C</td> <td>D63J</td> <td>18</td> <td>DK BL</td> <td>1661261C1</td> </tr> <tr> <td>D</td> <td>D63C</td> <td>18</td> <td>DK BL</td> <td>1661261C1</td> </tr> </tbody> </table>															CAV	CIRCUIT	GAUGE	COLOR	TERMINAL	A	D86F	16	LT GN	1661261C1	B	D11-GE	16	WH	1661261C1	C	D63J	18	DK BL	1661261C1	D	D63C	18	DK BL	1661261C1															
CAV	CIRCUIT	GAUGE	COLOR	TERMINAL																																																		
A	D86F	16	LT GN	1661261C1																																																		
B	D11-GE	16	WH	1661261C1																																																		
C	D63J	18	DK BL	1661261C1																																																		
D	D63C	18	DK BL	1661261C1																																																		
<p>IP / AUX ROOF (2502M) (LOCATED IN INSTRUMENT PANEL RIGHT SIDE)</p>  <p>CONNECTOR 1667305C1 BODY LOCK 1661263C1</p> <table border="1" style="width:100%; border-collapse: collapse; font-size: x-small;"> <thead> <tr> <th>CAV</th> <th>CIRCUIT</th> <th>GAUGE</th> <th>COLOR</th> <th>TERMINAL</th> </tr> </thead> <tbody> <tr> <td>A</td> <td>A86F</td> <td>16</td> <td>LTGN</td> <td>1661261C1</td> </tr> <tr> <td>B</td> <td>A11-GE</td> <td>16</td> <td>WH</td> <td>1661261C1</td> </tr> <tr> <td>C</td> <td>A63J</td> <td>18</td> <td>DKBL</td> <td>1661261C1</td> </tr> <tr> <td>C</td> <td>A63N</td> <td>18</td> <td>DKBL</td> <td>1661261C1</td> </tr> <tr> <td>C</td> <td>A63D</td> <td>18</td> <td>DKBL</td> <td>1661261C1</td> </tr> <tr> <td>D</td> <td>A63C</td> <td>18</td> <td>DKBL</td> <td>1661261C1</td> </tr> <tr> <td>D</td> <td>A63E</td> <td>18</td> <td>DKBL</td> <td>1661261C1</td> </tr> </tbody> </table>															CAV	CIRCUIT	GAUGE	COLOR	TERMINAL	A	A86F	16	LTGN	1661261C1	B	A11-GE	16	WH	1661261C1	C	A63J	18	DKBL	1661261C1	C	A63N	18	DKBL	1661261C1	C	A63D	18	DKBL	1661261C1	D	A63C	18	DKBL	1661261C1	D	A63E	18	DKBL	1661261C1
CAV	CIRCUIT	GAUGE	COLOR	TERMINAL																																																		
A	A86F	16	LTGN	1661261C1																																																		
B	A11-GE	16	WH	1661261C1																																																		
C	A63J	18	DKBL	1661261C1																																																		
C	A63N	18	DKBL	1661261C1																																																		
C	A63D	18	DKBL	1661261C1																																																		
D	A63C	18	DKBL	1661261C1																																																		
D	A63E	18	DKBL	1661261C1																																																		
CHK	DATE	CHANGE	REV	REFERENCE	DRAWN	NAME																																																
0638	09FEB15	INITIAL RELEASE.	A	92855Z	MJVO370	CIRCUIT DIAGRAM, TERRASTAR																																																
RELEASE NO.		DATE		PART NO.		SHEET																																																
92855Z		10DEC14		AE08068784		37C																																																

Figure 196 Connector Body Composites (2302M / 2304M / 2305M / 2502M)

13.44. CONNECTOR BODY COMPOSITES (2503 / 2600 / 2601M / 2602M), P. 38

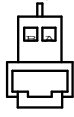
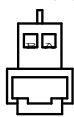
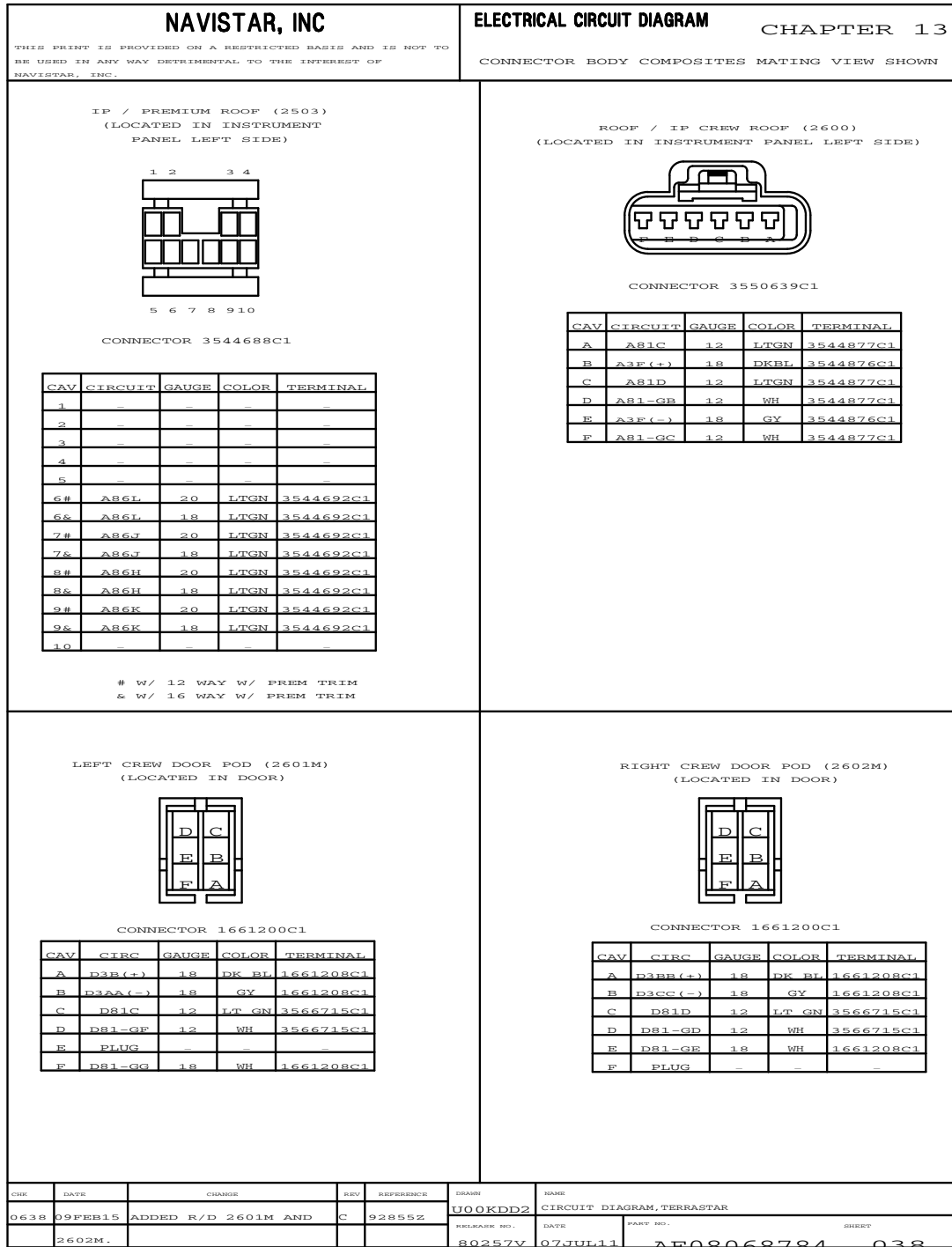

Figure 197 Connector Body Composites (2503 / 2600 / 2601M / 2602M)

13.45. CONNECTOR BODY COMPOSITES (3000 / 3001 / 3003 / 3100M / 3200), P. 39

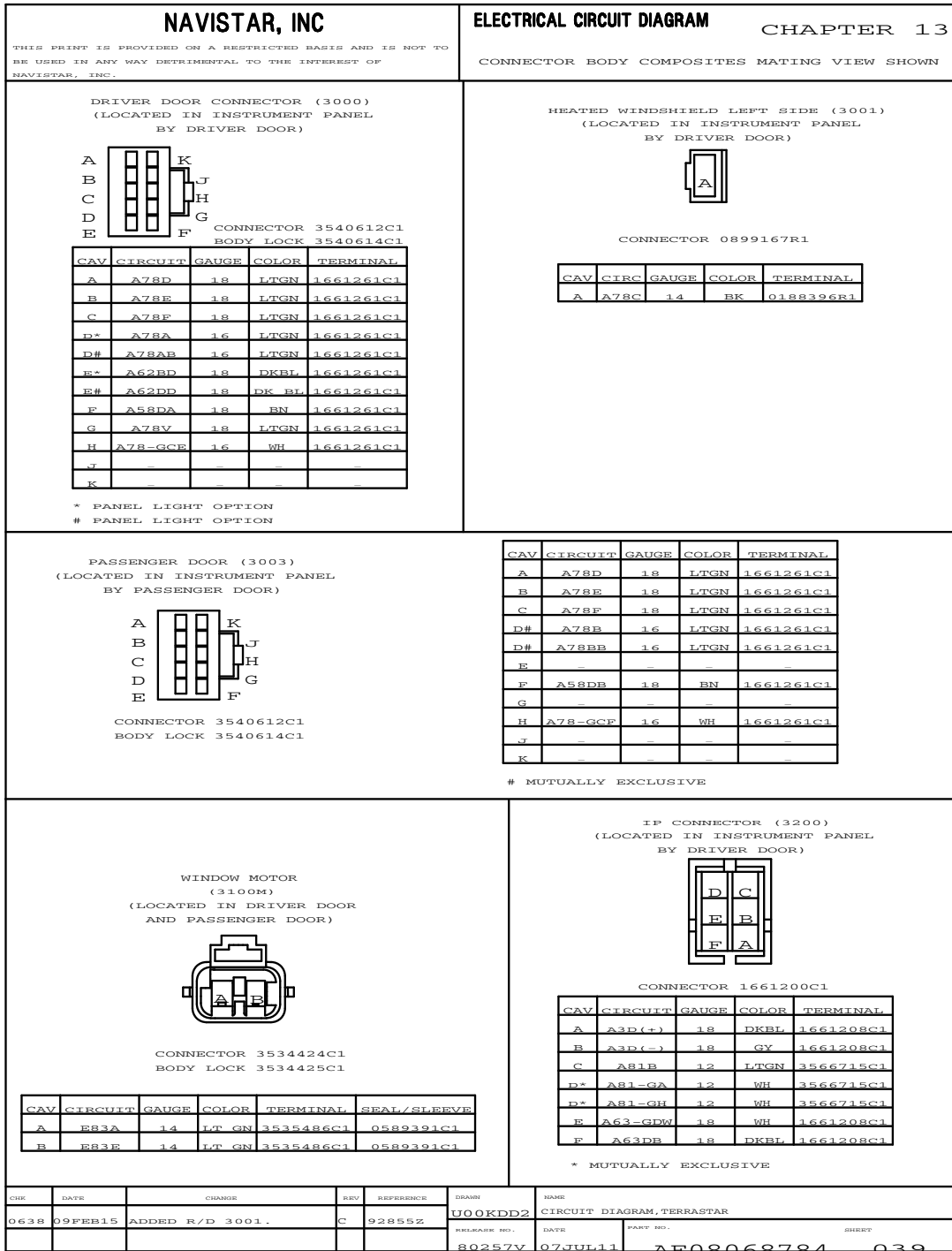

Figure 198 Connector Body Composites (3000 / 3001 / 3003 / 3100M / 3200)

13.46. CONNECTOR BODY COMPOSITES (3201M / 3202M / 3203M / 3205M / 3206 / 3209M), P. 39A

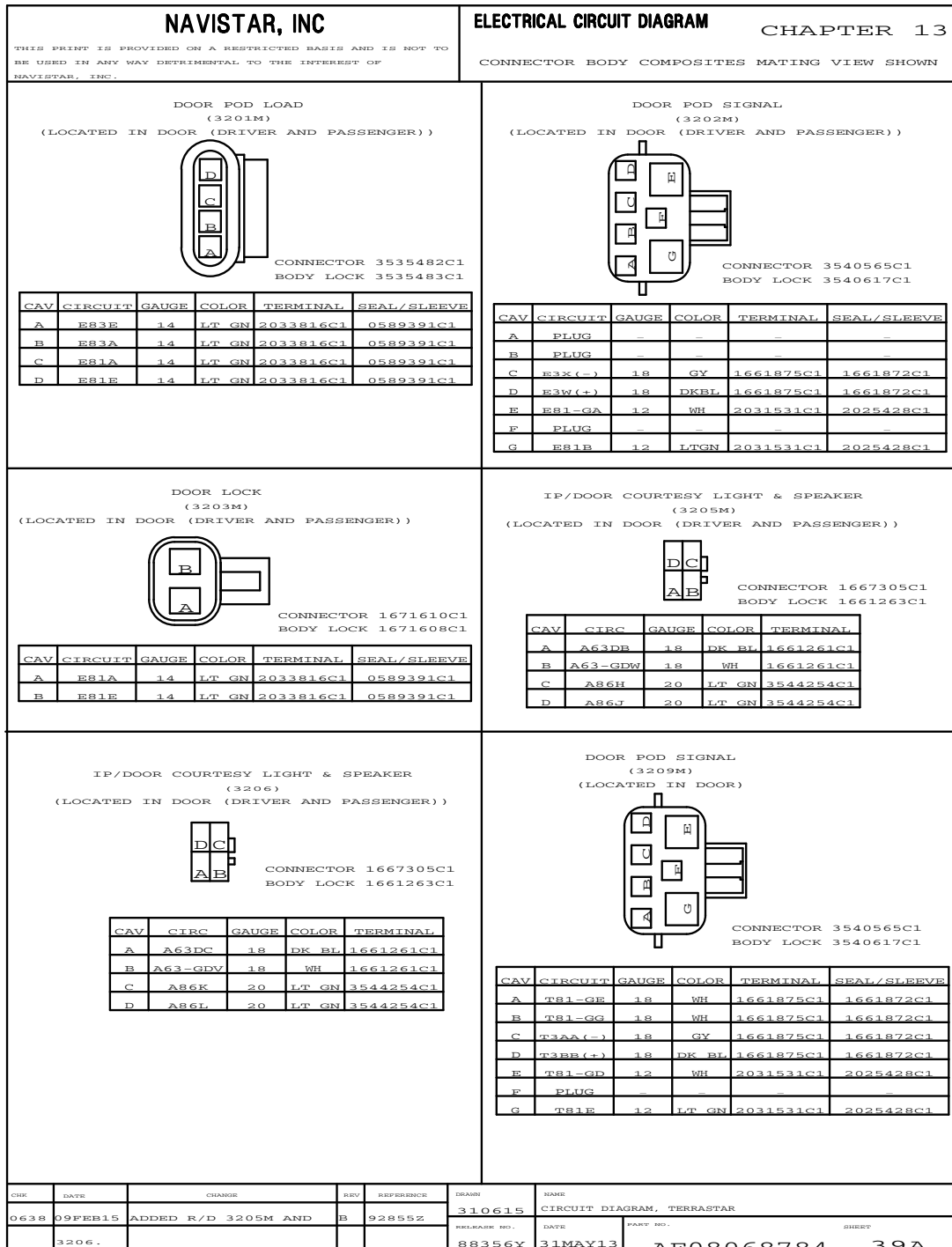

Figure 199 Connector Body Composites (3201M / 3202M / 3203M / 3205M / 3206 / 3209M)

13.47. CONNECTOR BODY COMPOSITES (3204 / 4000 / 4001 / 4004 / 4031 / 4032), P. 40

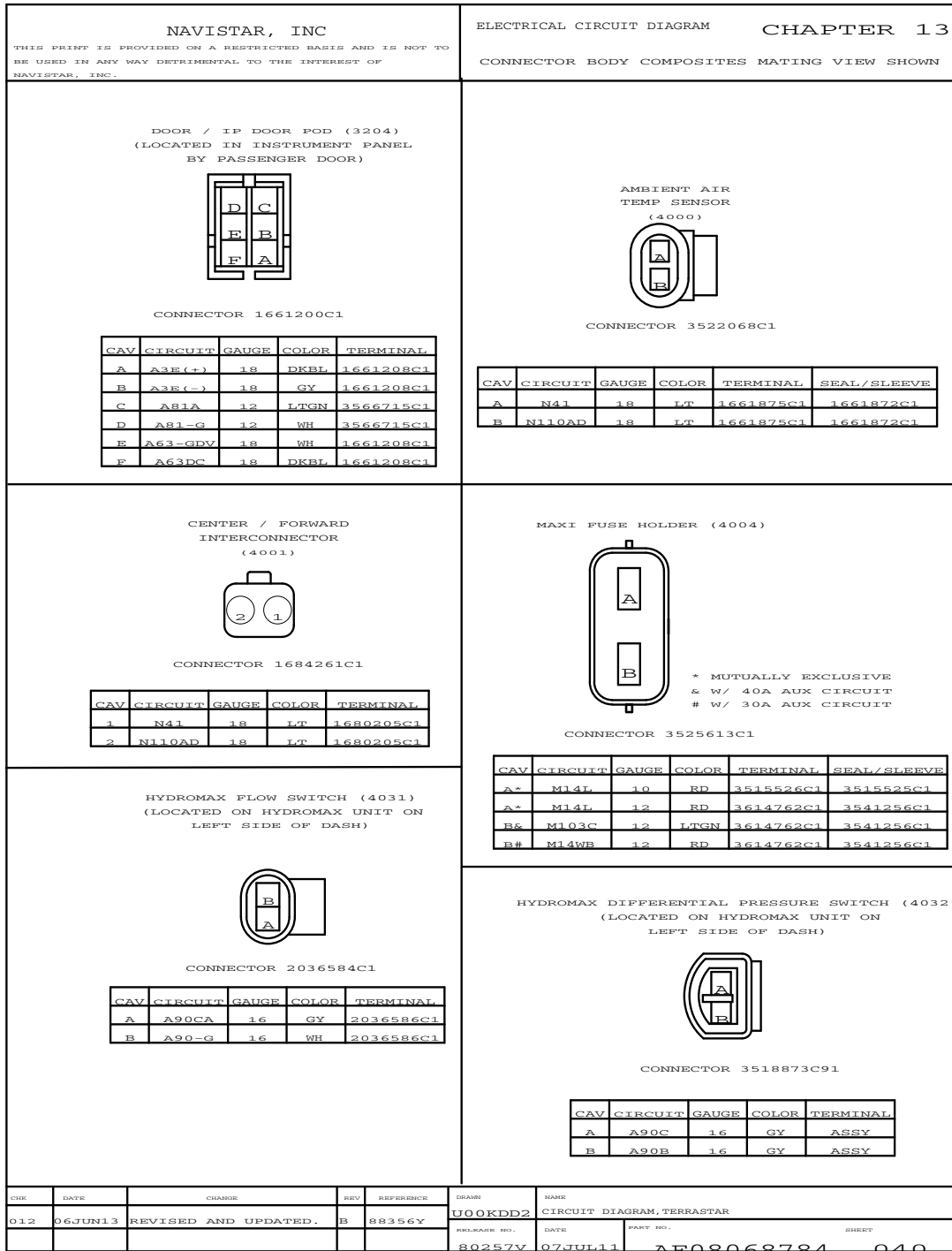

Figure 200 Connector Body Composites (3204 / 4000 / 4001 / 4004 / 4031 / 4032)

13.48. CONNECTOR BODY COMPOSITES (4033 / 4040 / 4041 / 4060 / 4087), P. 40A

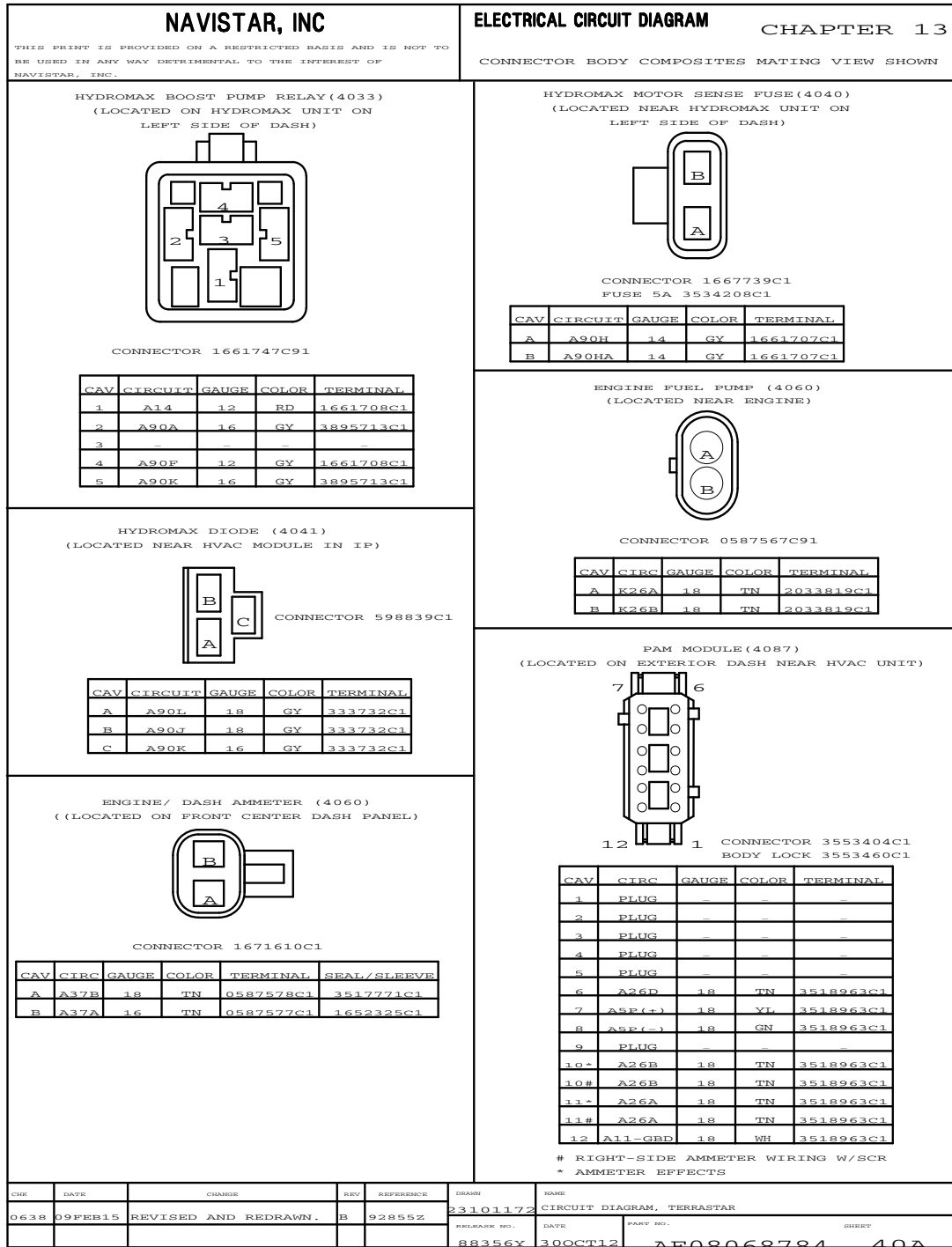

Figure 201 Connector Body Composites (4033 / 4040 / 4041 / 4060 / 4087)

13.49. CONNECTOR BODY COMPOSITES (4410A / 4410B / 4410D / 4411F / 4411M / 4412F), P. 40B

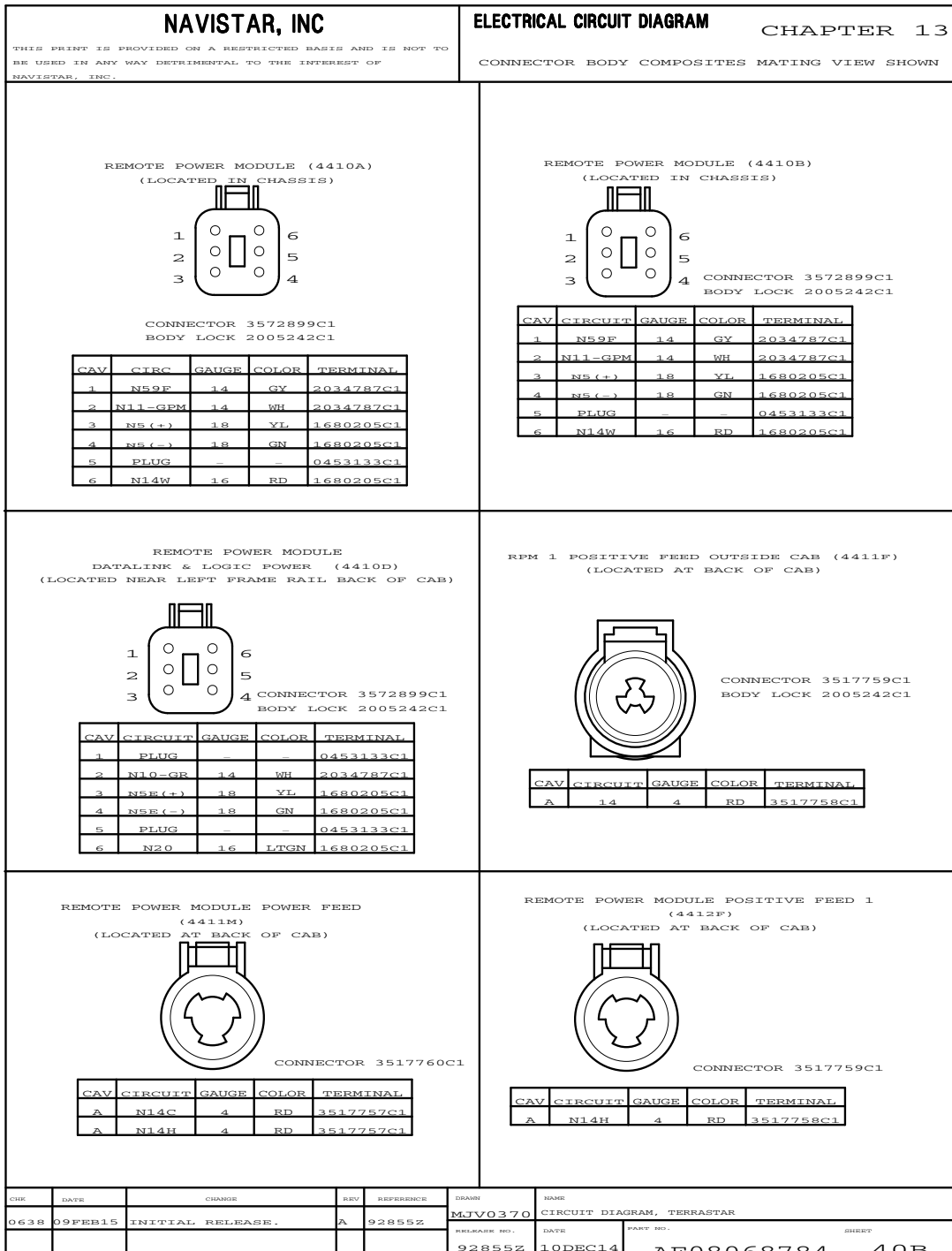

Figure 202 Connector Body Composites (4410A / 4410B / 4410D / 4411F / 4411M / 4412F)

13.50. CONNECTOR BODY COMPOSITES (4412F1 / 4450AM / 4450BM / 4450M / 4060), P. 41

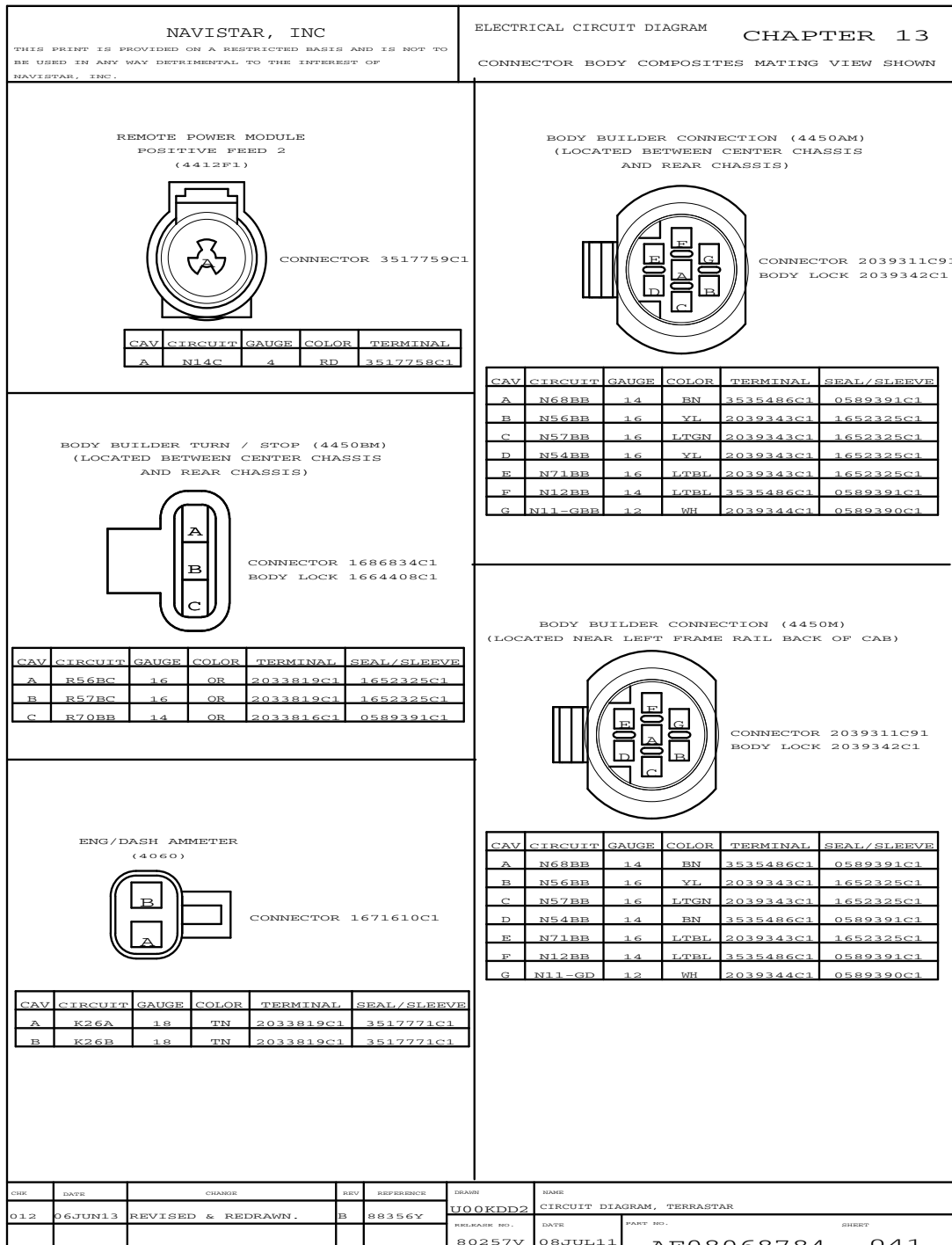

Figure 203 Connector Body Composites (4412F1 / 4450AM / 4450BM / 4450M / 4060)

13.51. CONNECTOR BODY COMPOSITES (4460AM / 4460BF / 4460BM / 4450BF / 4460M / 4500 / 4906), P. 42

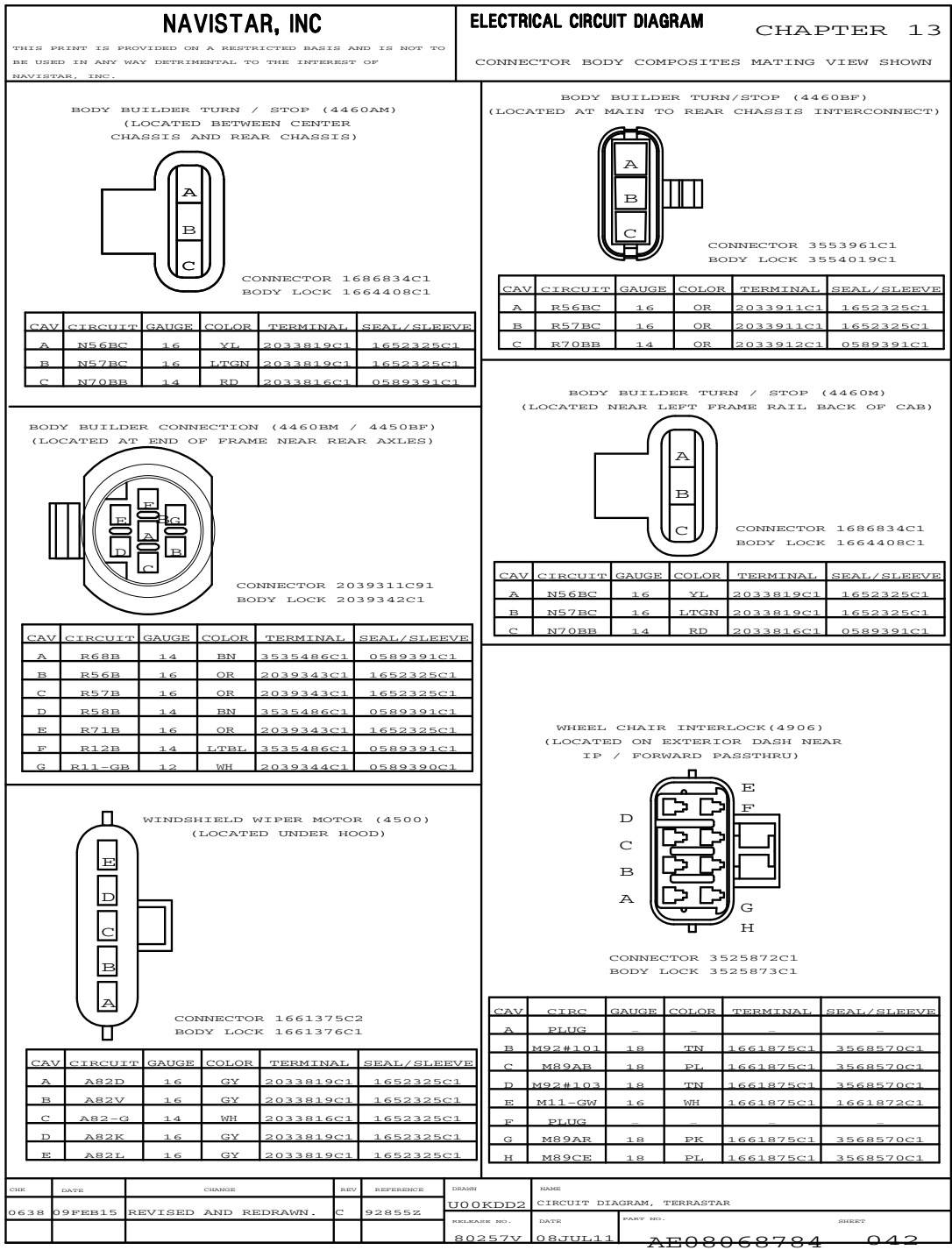

Figure 204 Connector Body Composites (4460AM / 4460BF / 4460BM / 4450BF / 4460M / 4500 / 4906)

13.52. CONNECTOR BODY COMPOSITES (6011 / 6020M), P. 43

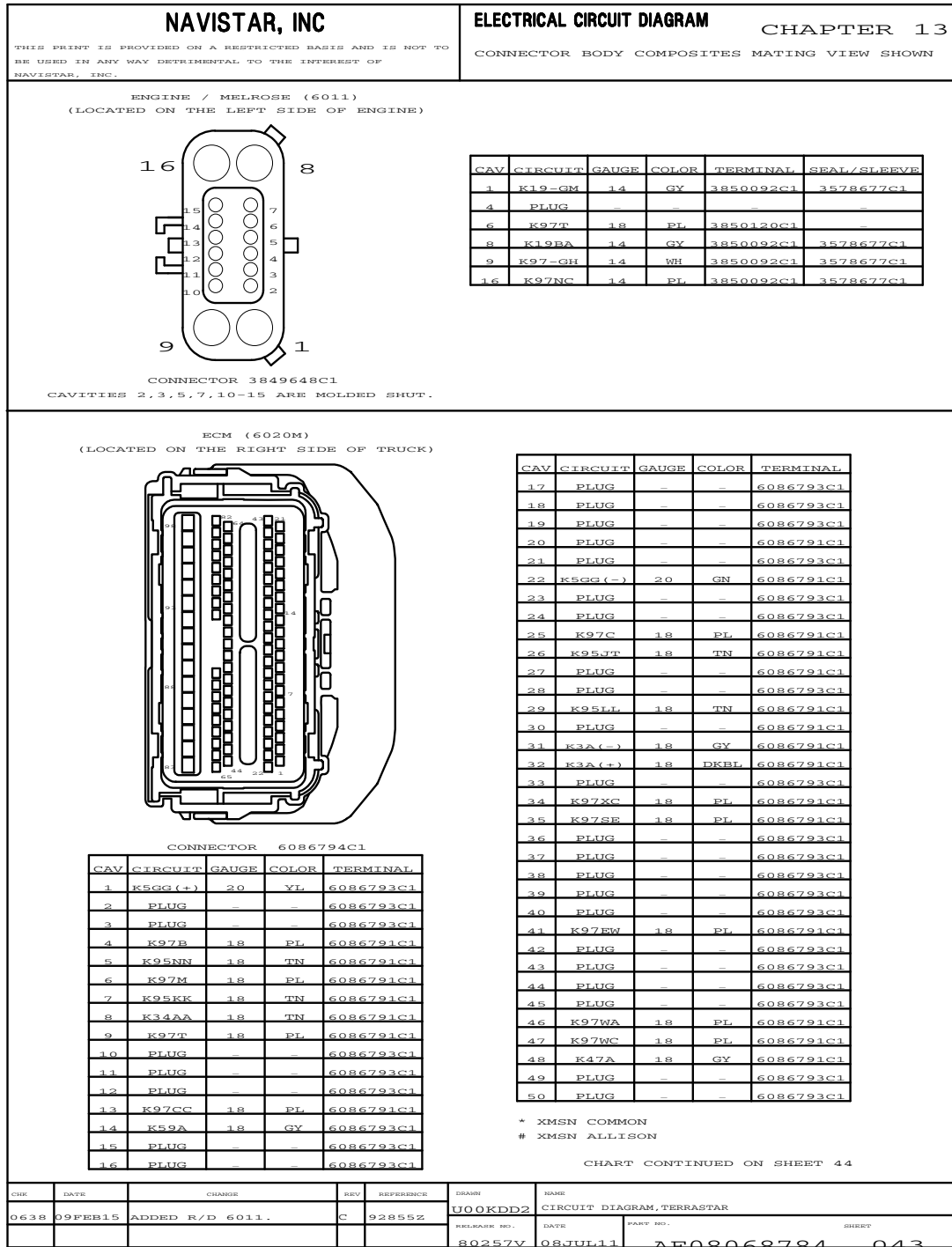

Figure 205 Connector Body Composites (6011 / 6020M)

13.53. CONNECTOR BODY COMPOSITES (6020M), P. 44

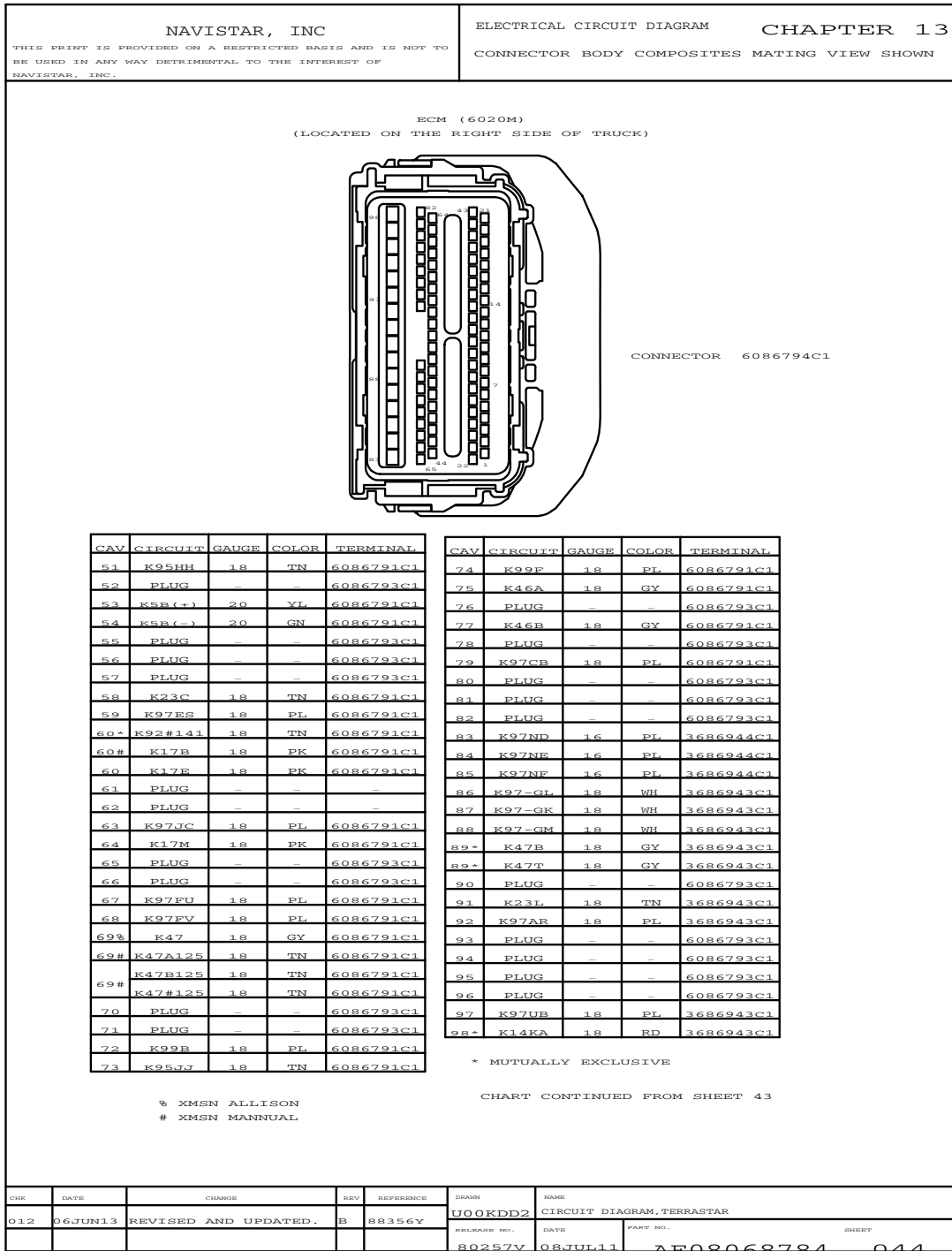

Figure 206 Connector Body Composites (6020M)

13.54. CONNECTOR BODY COMPOSITES (6022 / 6022A / 6200 / 6260HL / 6620HR / 6620T / 6260UC / 6260T / 6261 / 6261T / 6261NV), P. 45

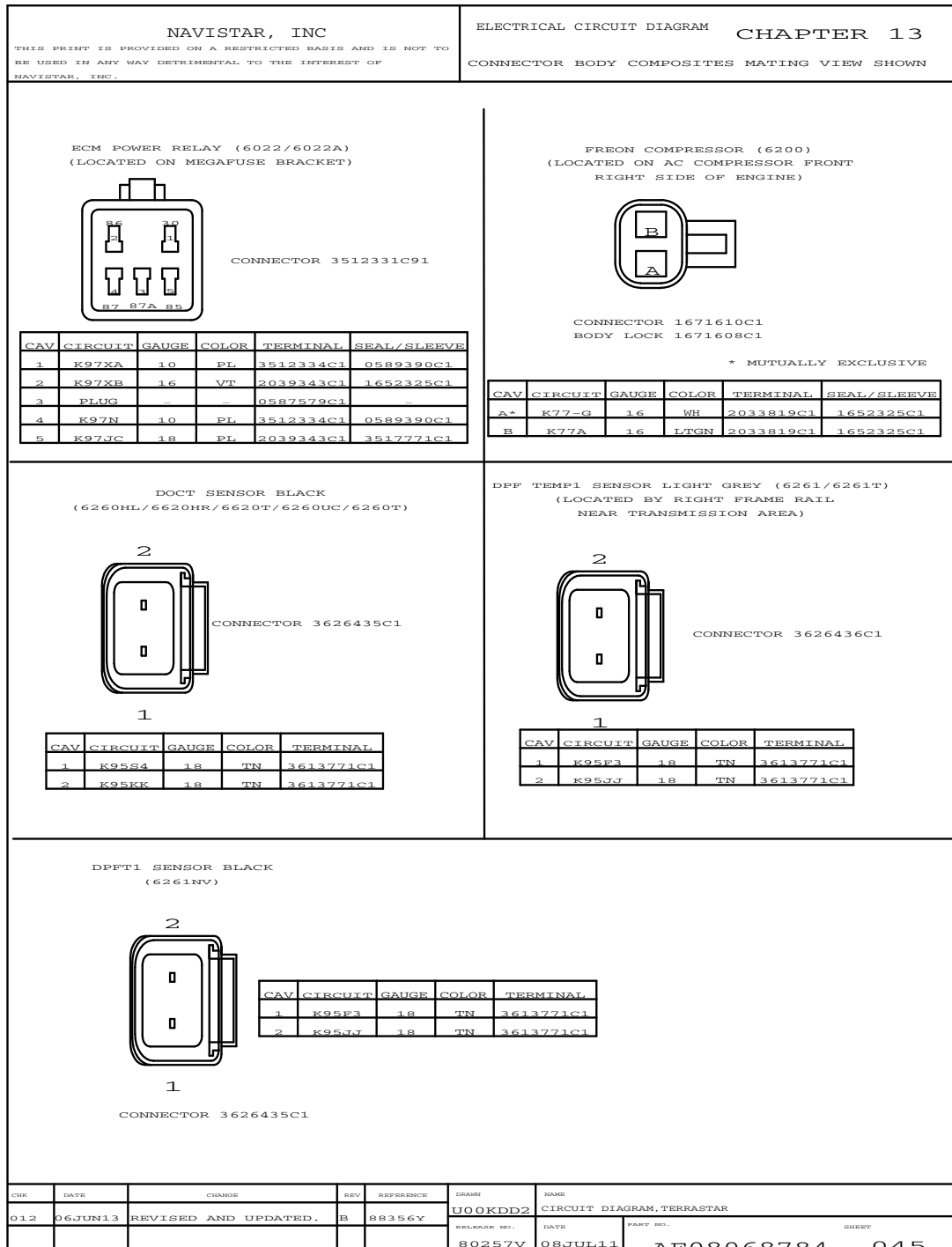

Figure 207 Connector Body Composites (6022 / 6022A / 6200 / 6260HL / 6620HR / 6620T / 6260UC / 6260T / 6261 / 6261T / 6261NV)

13.55. CONNECTOR BODY COMPOSITES (6262 / 6262NV / 6262T / 6263 / 6263NV / 6263T / 6322), P. 45A

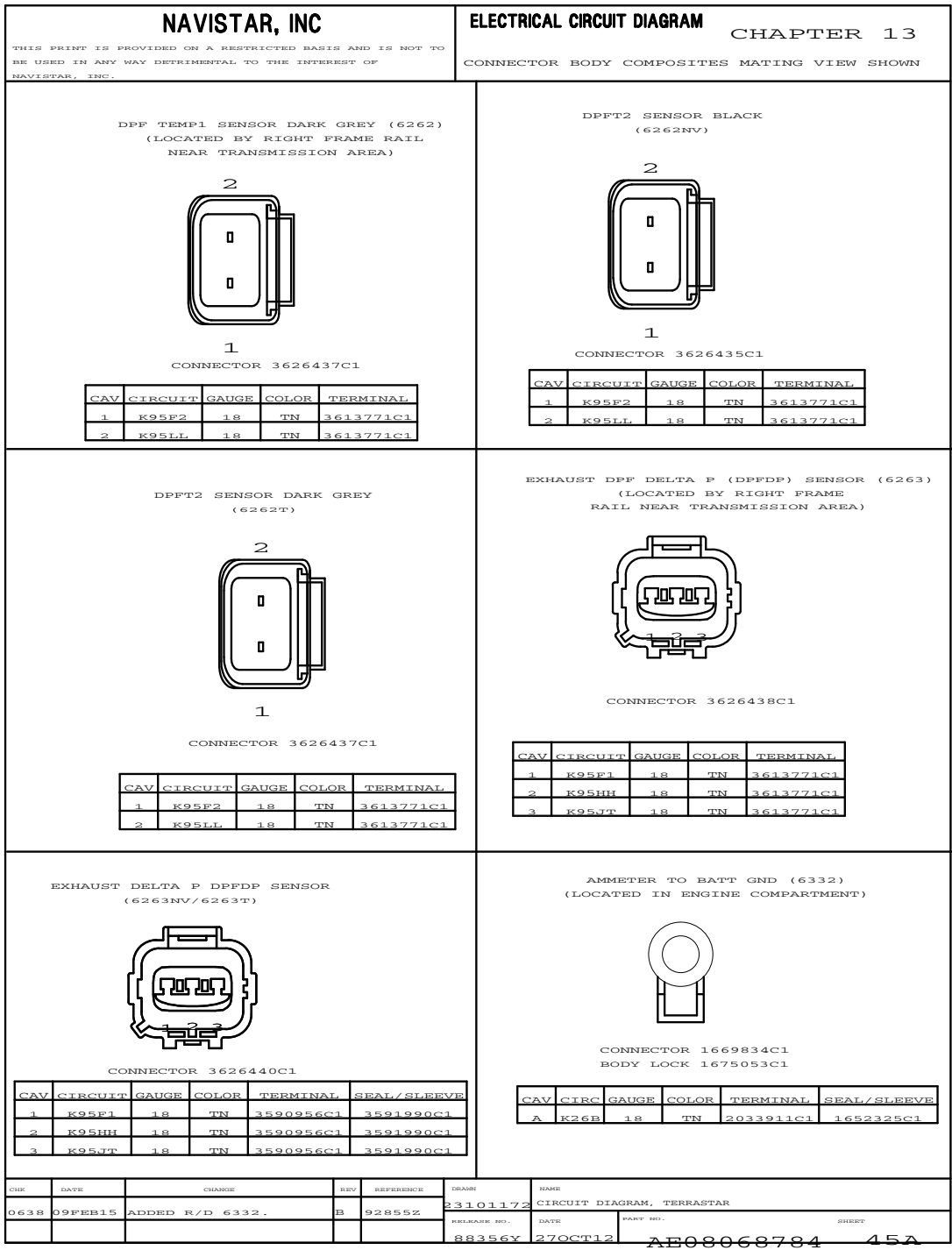

Figure 208 Connector Body Composites (6262 / 6262NV / 6262T / 6263 / 6263NV / 6263T / 6322)

13.56. CONNECTOR BODY COMPOSITES (6333 / 6334 / 6400 / 6405 / 6561 / 6704M), P. 46

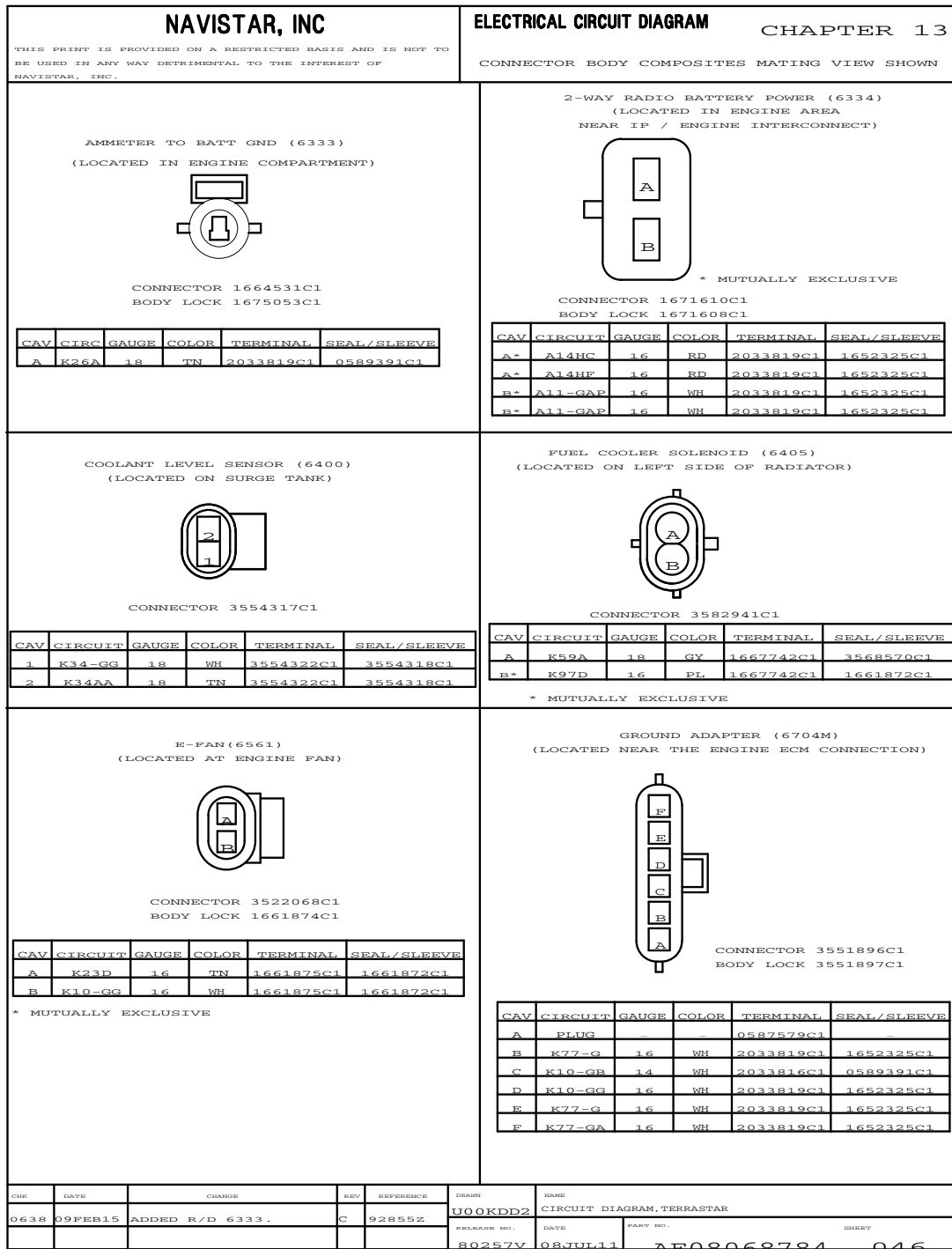

Figure 209 Connector Body Composites (6333 / 6334 / 6400 / 6405 / 6561 / 6704M)

13.57. CONNECTOR BODY COMPOSITES (6747 / 6900 / 7100 / 7103M), P. 47

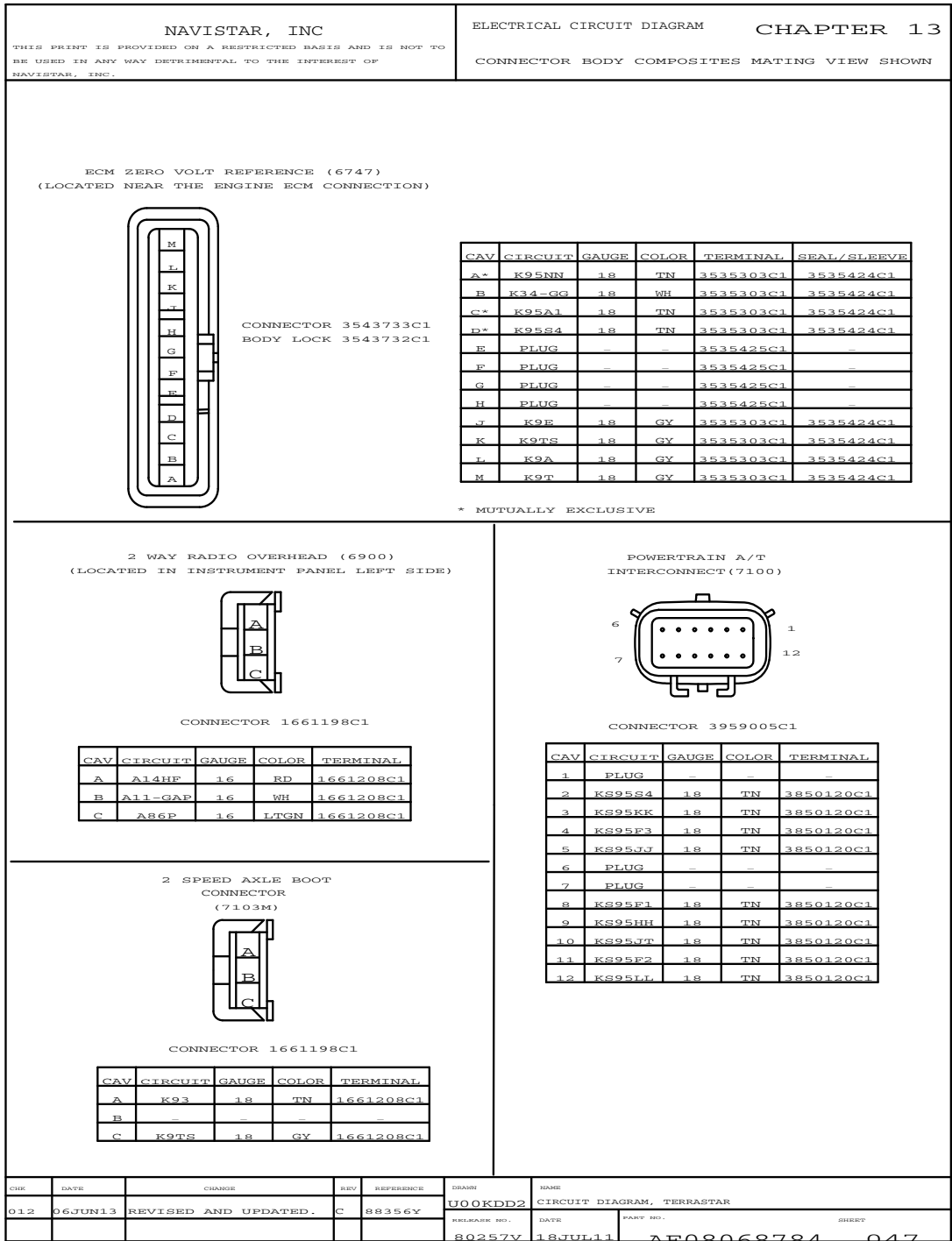

Figure 210 Connector Body Composites (6747 / 6900 / 7100 / 7103M)

13.58. CONNECTOR BODY COMPOSITES (7150), P. 47A

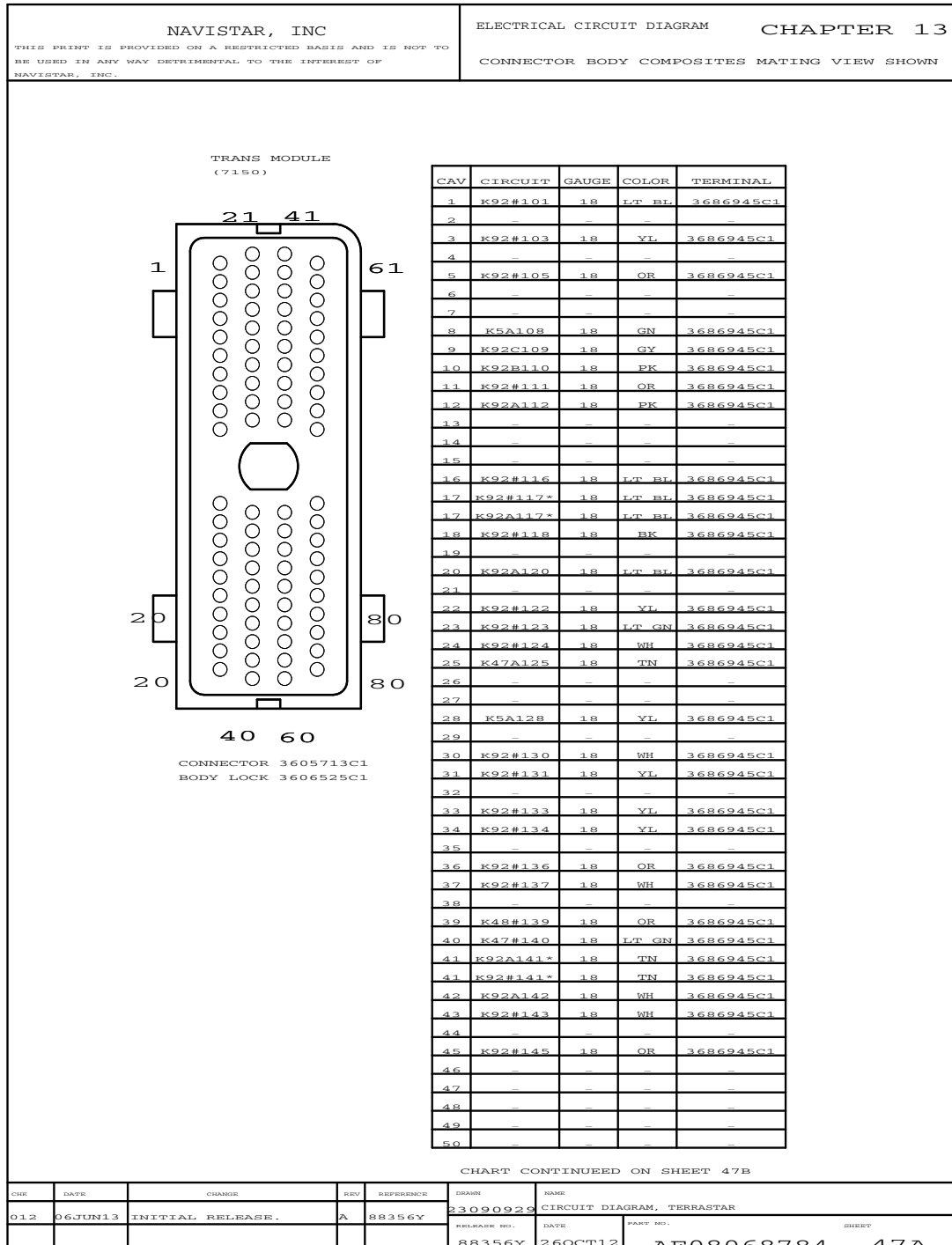

Figure 211 Connector Body Composites (7150)

13.59. CONNECTOR BODY COMPOSITES (7150), P. 47B

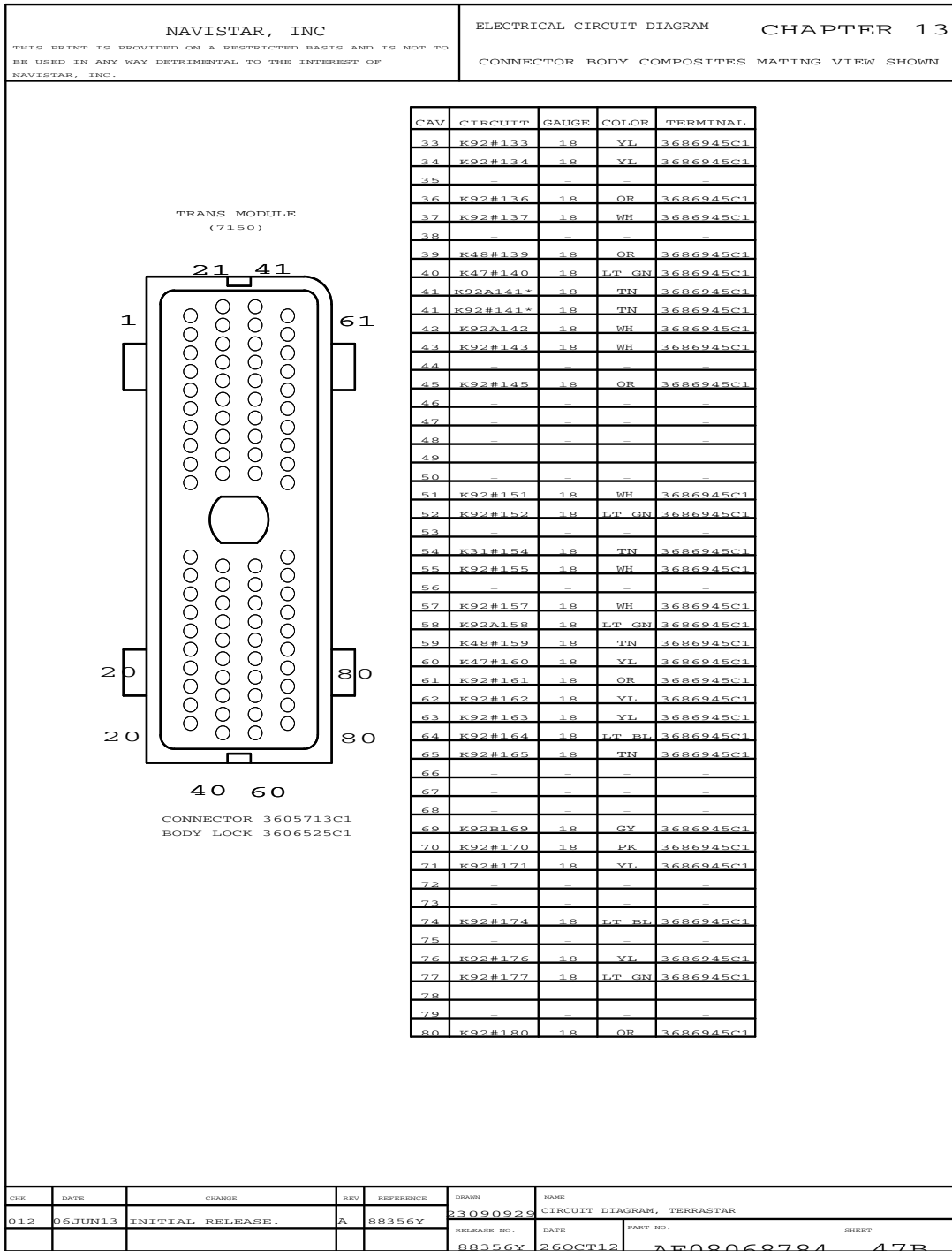

Figure 212 Connector Body Composites (7150)

13.60. CONNECTOR BODY COMPOSITES (7151), P. 48

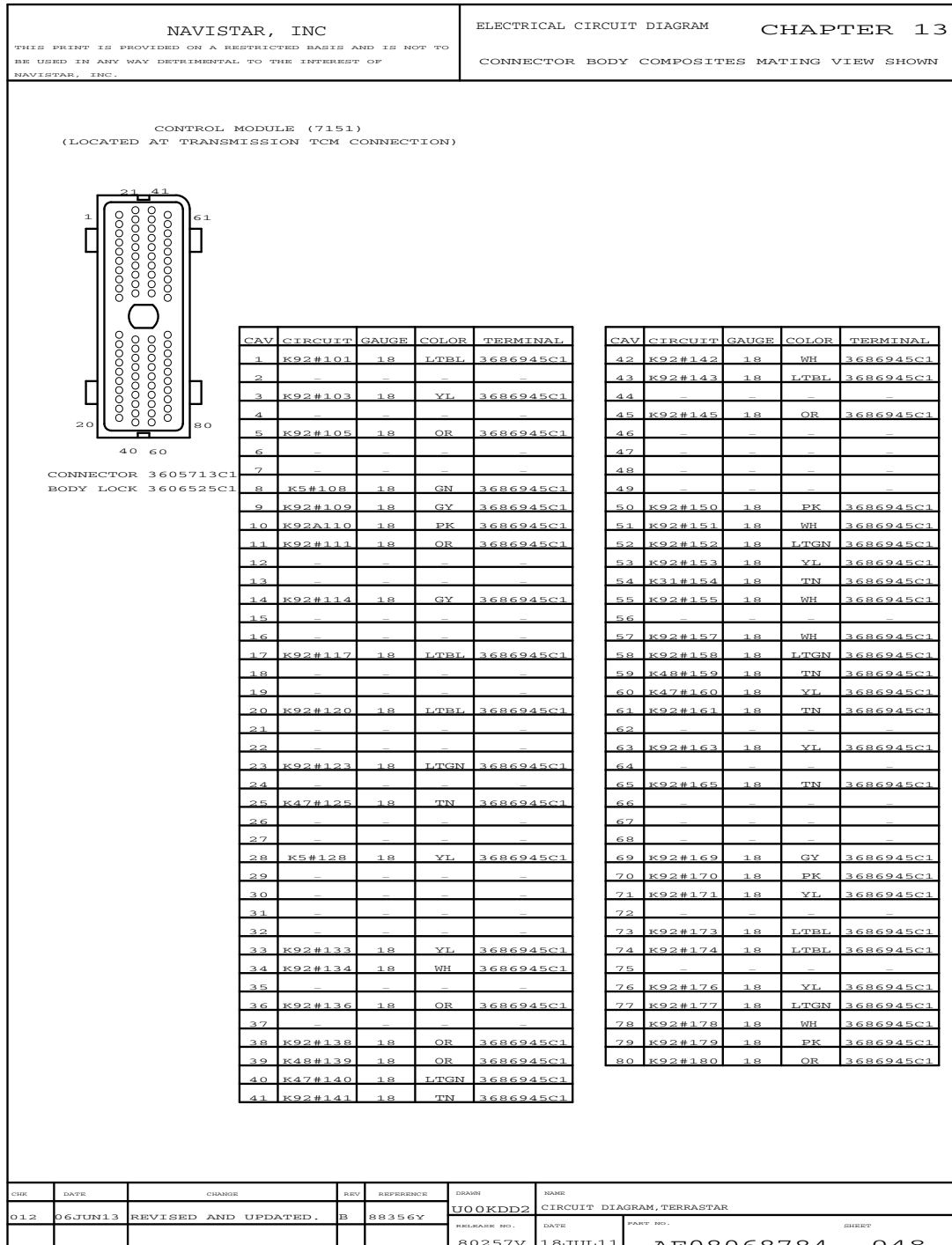

Figure 213 Connector Body Composites (7151)

13.61. CONNECTOR BODY COMPOSITES (7205F / 7206F / 7207M / 7207MA), P. 49

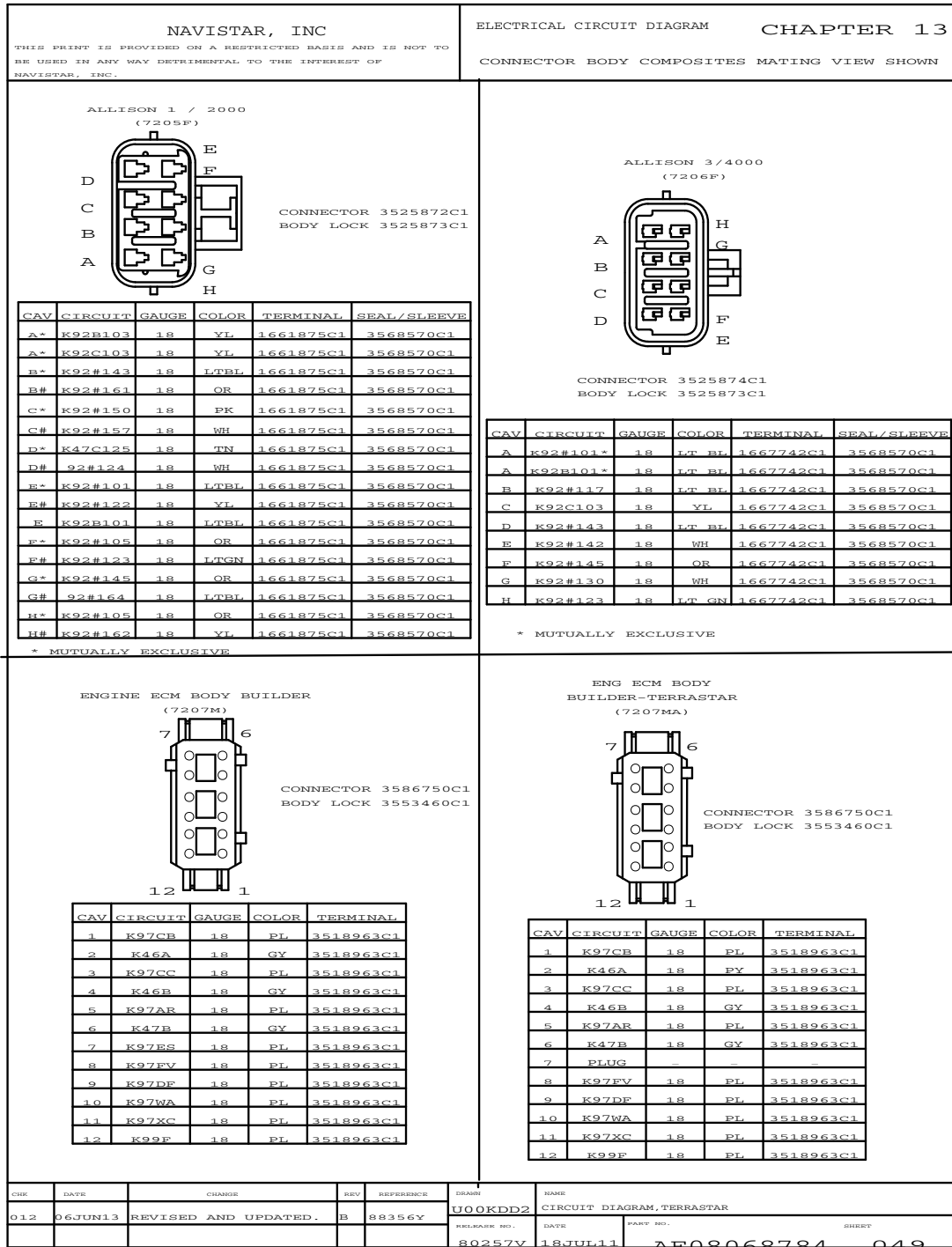

Figure 214 Connector Body Composites (7205F / 7206F / 7207M / 7207MA)

13.62. CONNECTOR BODY COMPOSITES (7208M / 7208A / 7250M / 7350 / 7500M / 7600M), P. 49A

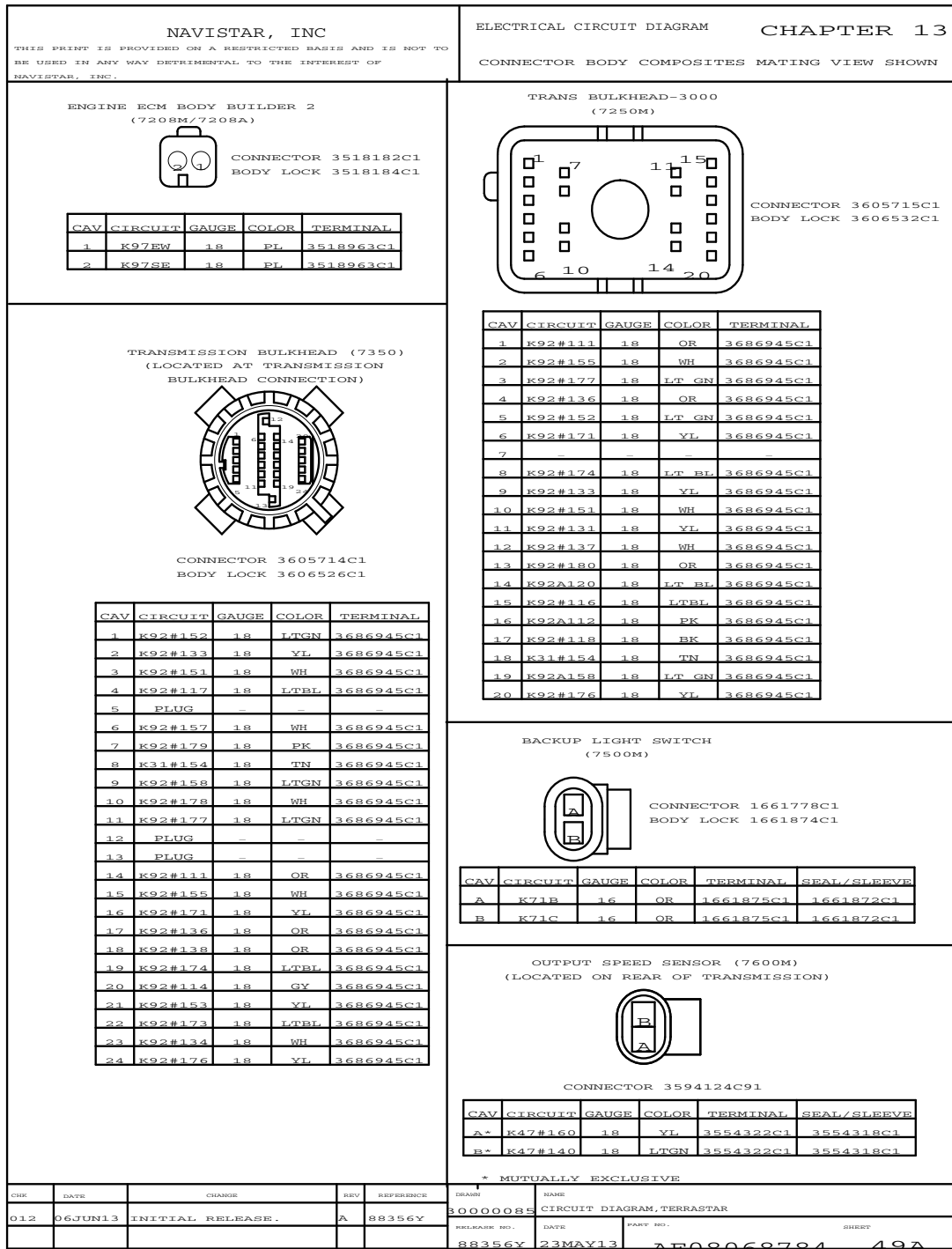

Figure 215 Connector Body Composites (7208M / 7208A / 7250M / 7350 / 7500M / 7600M)

13.63. CONNECTOR BODY COMPOSITES (7601M / 7603M / 7604M / 7605M / 7607M / 7611 / 7700M / 7710), P. 50

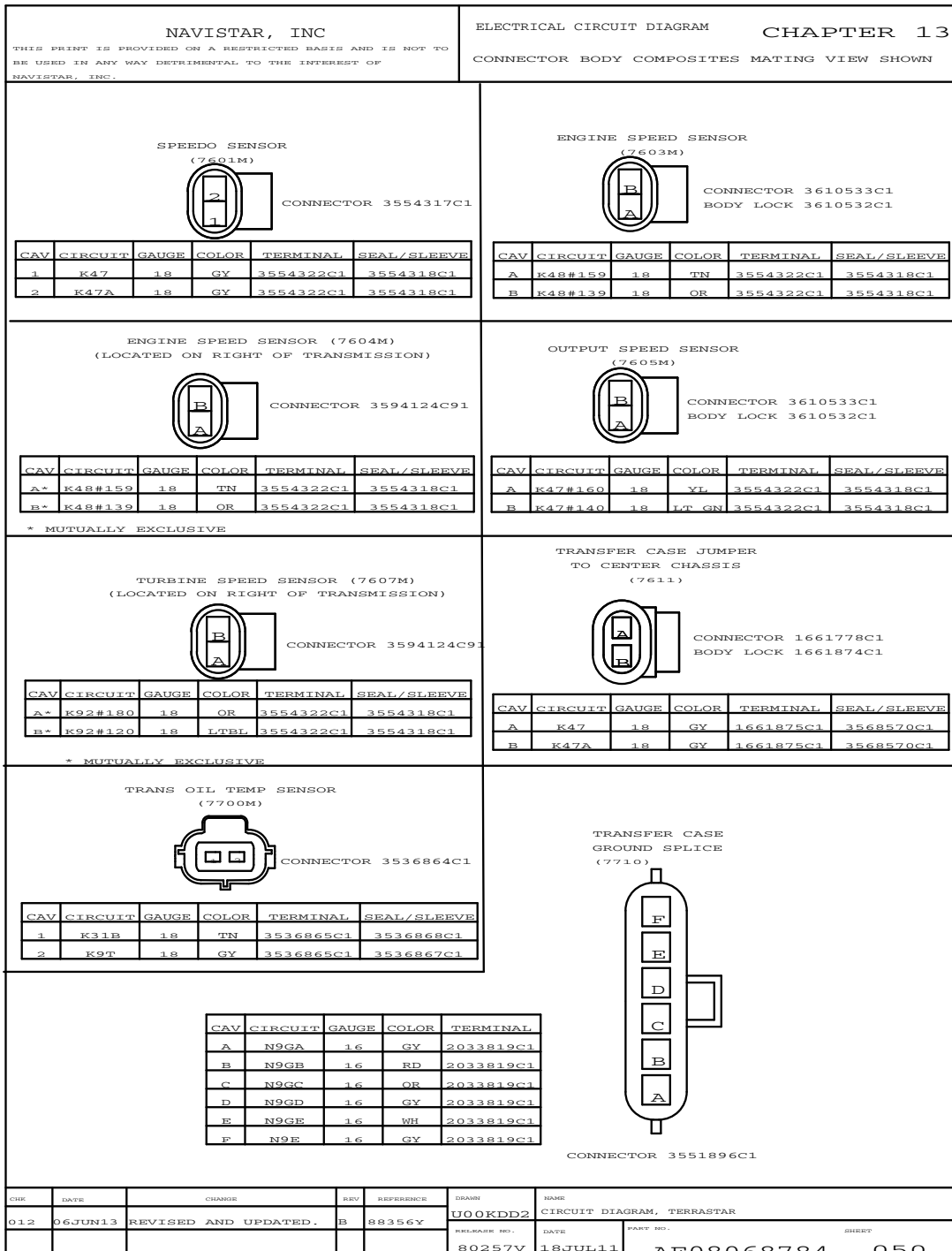

Figure 216 Connector Body Composites (7601M / 7603M / 7604M / 7605M / 7607M / 7611 / 7700M / 7710)

13.64. CONNECTOR BODY COMPOSITES (7711 / 7801M / 8000 / 8001), P. 50A

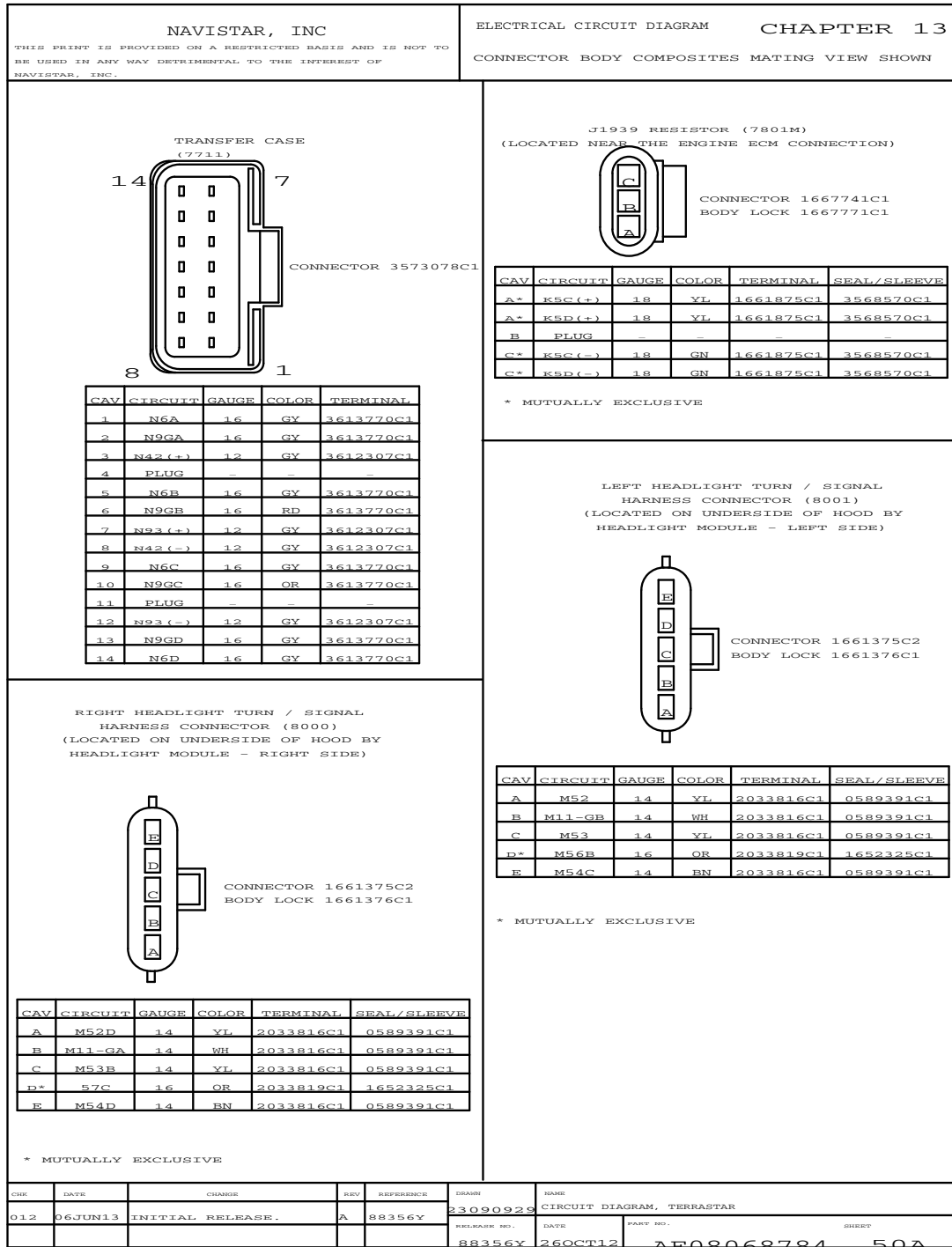

Figure 217 Connector Body Composites (7711 / 7801M / 8000 / 8001)

13.65. CONNECTOR BODY COMPOSITES (8102 / 8150 / 8151 / 8200 / 8201 / 8301), P. 51

NAVISTAR, INC <small>THIS PRINT IS PROVIDED ON A RESTRICTED BASIS AND IS NOT TO BE USED IN ANY WAY DETRIMENTAL TO THE INTEREST OF NAVISTAR, INC.</small>				ELECTRICAL CIRCUIT DIAGRAM CHAPTER 13 CONNECTOR BODY COMPOSITES MATING VIEW SHOWN																																																																					
SNOWPLOW HARNESS CONNECTOR (8102) (LOCATED BY LEFT FRAME RAIL NEAR HOOD)				LEFT GUIDE POST LIGHT (8150) (LOCATED ON HOOD LEFT SIDE)																																																																					
																																																																									
CONNECTOR 2039311C91 BODY LOCK 2039342C1				CONNECTOR 1661778C1 BODY LOCK 1661874C1																																																																					
<table border="1" style="width:100%; border-collapse: collapse;"> <thead> <tr> <th>CAV</th> <th>CIRCUIT</th> <th>GAUGE</th> <th>COLOR</th> <th>TERMINAL</th> <th>SEAL/SLEEVE</th> </tr> </thead> <tbody> <tr><td>A</td><td>M64HI</td><td>14</td><td>YL</td><td>3535486C1</td><td>0589391C1</td></tr> <tr><td>B</td><td>M11-GE</td><td>14</td><td>WH</td><td>3535486C1</td><td>0589391C1</td></tr> <tr><td>C</td><td>M64LO</td><td>14</td><td>YL</td><td>3535486C1</td><td>0589391C1</td></tr> <tr><td>D</td><td>M56D</td><td>16</td><td>YL</td><td>2039343C1</td><td>1652325C1</td></tr> <tr><td>E</td><td>M54F</td><td>14</td><td>BN</td><td>3535486C1</td><td>0589391C1</td></tr> <tr><td>F</td><td>M57D</td><td>16</td><td>LTGN</td><td>2039343C1</td><td>1652325C1</td></tr> <tr><td>G</td><td>PLUG</td><td>-</td><td>-</td><td>0587579C1</td><td>-</td></tr> </tbody> </table>				CAV	CIRCUIT	GAUGE	COLOR	TERMINAL	SEAL/SLEEVE	A	M64HI	14	YL	3535486C1	0589391C1	B	M11-GE	14	WH	3535486C1	0589391C1	C	M64LO	14	YL	3535486C1	0589391C1	D	M56D	16	YL	2039343C1	1652325C1	E	M54F	14	BN	3535486C1	0589391C1	F	M57D	16	LTGN	2039343C1	1652325C1	G	PLUG	-	-	0587579C1	-	<table border="1" style="width:100%; border-collapse: collapse;"> <thead> <tr> <th>CAV</th> <th>CIRCUIT</th> <th>GAUGE</th> <th>COLOR</th> <th>TERMINAL</th> <th>SEAL/SLEEVE</th> </tr> </thead> <tbody> <tr><td>A</td><td>M54H</td><td>16</td><td>BN</td><td>1661875C1</td><td>1661872C1</td></tr> <tr><td>B</td><td>M54-GA</td><td>16</td><td>WH</td><td>1661875C1</td><td>1661872C1</td></tr> </tbody> </table>				CAV	CIRCUIT	GAUGE	COLOR	TERMINAL	SEAL/SLEEVE	A	M54H	16	BN	1661875C1	1661872C1	B	M54-GA	16	WH	1661875C1	1661872C1
CAV	CIRCUIT	GAUGE	COLOR	TERMINAL	SEAL/SLEEVE																																																																				
A	M64HI	14	YL	3535486C1	0589391C1																																																																				
B	M11-GE	14	WH	3535486C1	0589391C1																																																																				
C	M64LO	14	YL	3535486C1	0589391C1																																																																				
D	M56D	16	YL	2039343C1	1652325C1																																																																				
E	M54F	14	BN	3535486C1	0589391C1																																																																				
F	M57D	16	LTGN	2039343C1	1652325C1																																																																				
G	PLUG	-	-	0587579C1	-																																																																				
CAV	CIRCUIT	GAUGE	COLOR	TERMINAL	SEAL/SLEEVE																																																																				
A	M54H	16	BN	1661875C1	1661872C1																																																																				
B	M54-GA	16	WH	1661875C1	1661872C1																																																																				
RIGHT GUIDE POST LIGHT (8151) (LOCATED ON HOOD RIGHT SIDE)				RIGHT FOG LIGHT (8200) (LOCATED AT THE FORWARD END OF RIGHT FRAME RAIL)																																																																					
																																																																									
CONNECTOR 1661778C1 BODY LOCK 1661874C1				CONNECTOR 0587567C91																																																																					
<table border="1" style="width:100%; border-collapse: collapse;"> <thead> <tr> <th>CAV</th> <th>CIRCUIT</th> <th>GAUGE</th> <th>COLOR</th> <th>TERMINAL</th> <th>SEAL/SLEEVE</th> </tr> </thead> <tbody> <tr><td>A</td><td>M54J</td><td>16</td><td>BN</td><td>1661875C1</td><td>1661872C1</td></tr> <tr><td>B</td><td>M54-GB</td><td>16</td><td>WH</td><td>1661875C1</td><td>1661872C1</td></tr> </tbody> </table>				CAV	CIRCUIT	GAUGE	COLOR	TERMINAL	SEAL/SLEEVE	A	M54J	16	BN	1661875C1	1661872C1	B	M54-GB	16	WH	1661875C1	1661872C1	<table border="1" style="width:100%; border-collapse: collapse;"> <thead> <tr> <th>CAV</th> <th>CIRCUIT</th> <th>GAUGE</th> <th>COLOR</th> <th>TERMINAL</th> <th>SEAL/SLEEVE</th> </tr> </thead> <tbody> <tr><td>A</td><td>M64B</td><td>16</td><td>YL</td><td>0587577C1</td><td>1652325C1</td></tr> <tr><td>B</td><td>M64-GB</td><td>16</td><td>WH</td><td>0587577C1</td><td>1652325C1</td></tr> </tbody> </table>				CAV	CIRCUIT	GAUGE	COLOR	TERMINAL	SEAL/SLEEVE	A	M64B	16	YL	0587577C1	1652325C1	B	M64-GB	16	WH	0587577C1	1652325C1																														
CAV	CIRCUIT	GAUGE	COLOR	TERMINAL	SEAL/SLEEVE																																																																				
A	M54J	16	BN	1661875C1	1661872C1																																																																				
B	M54-GB	16	WH	1661875C1	1661872C1																																																																				
CAV	CIRCUIT	GAUGE	COLOR	TERMINAL	SEAL/SLEEVE																																																																				
A	M64B	16	YL	0587577C1	1652325C1																																																																				
B	M64-GB	16	WH	0587577C1	1652325C1																																																																				
LEFT FOG LIGHT (8201) (LOCATED AT THE FORWARD END OF LEFT FRAME RAIL)				ELECTRIC HORN (8301) (LOCATED UNDER ENGINE CROSSMEMBER)																																																																					
																																																																									
CONNECTOR 0587567C91				CONNECTOR 1661778C1 BODY LOCK 1661874C1																																																																					
<table border="1" style="width:100%; border-collapse: collapse;"> <thead> <tr> <th>CAV</th> <th>CIRCUIT</th> <th>GAUGE</th> <th>COLOR</th> <th>TERMINAL</th> <th>SEAL/SLEEVE</th> </tr> </thead> <tbody> <tr><td>A</td><td>M64A</td><td>16</td><td>YL</td><td>0587577C1</td><td>1652325C1</td></tr> <tr><td>B</td><td>M64-GA</td><td>16</td><td>WH</td><td>0587577C1</td><td>1652325C1</td></tr> </tbody> </table>				CAV	CIRCUIT	GAUGE	COLOR	TERMINAL	SEAL/SLEEVE	A	M64A	16	YL	0587577C1	1652325C1	B	M64-GA	16	WH	0587577C1	1652325C1	<table border="1" style="width:100%; border-collapse: collapse;"> <thead> <tr> <th>CAV</th> <th>CIRCUIT</th> <th>GAUGE</th> <th>COLOR</th> <th>TERMINAL</th> <th>SEAL/SLEEVE</th> </tr> </thead> <tbody> <tr><td>A</td><td>M85E</td><td>16</td><td>GY</td><td>1661875C1</td><td>1661872C1</td></tr> <tr><td>B</td><td>M85-GA</td><td>16</td><td>WH</td><td>1661875C1</td><td>1661872C1</td></tr> </tbody> </table>				CAV	CIRCUIT	GAUGE	COLOR	TERMINAL	SEAL/SLEEVE	A	M85E	16	GY	1661875C1	1661872C1	B	M85-GA	16	WH	1661875C1	1661872C1																														
CAV	CIRCUIT	GAUGE	COLOR	TERMINAL	SEAL/SLEEVE																																																																				
A	M64A	16	YL	0587577C1	1652325C1																																																																				
B	M64-GA	16	WH	0587577C1	1652325C1																																																																				
CAV	CIRCUIT	GAUGE	COLOR	TERMINAL	SEAL/SLEEVE																																																																				
A	M85E	16	GY	1661875C1	1661872C1																																																																				
B	M85-GA	16	WH	1661875C1	1661872C1																																																																				
CHK	DATE	CHANGE	REV	REFERENCE	DRAWN	NAME																																																																			
CNAL	26JUL11	INITIAL RELEASE.	A	80257V	U00KDD2	CIRCUIT DIAGRAM, TERRASTAR																																																																			
					RELEASE NO.	DATE																																																																			
					80257V	18JUL11																																																																			
					PART NO.	SHEET																																																																			
					AE08068784	051																																																																			

Figure 218 Connector Body Composites (8102 / 8150 / 8151 / 8200 / 8201 / 8301)

13.66. CONNECTOR BODY COMPOSITES (8502 / 8503 / 8505A / 8600 / 8602 / 8800), P. 52

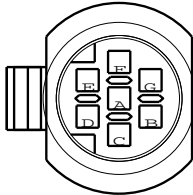
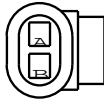
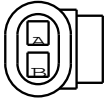
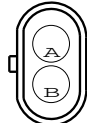
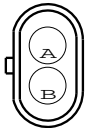
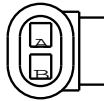
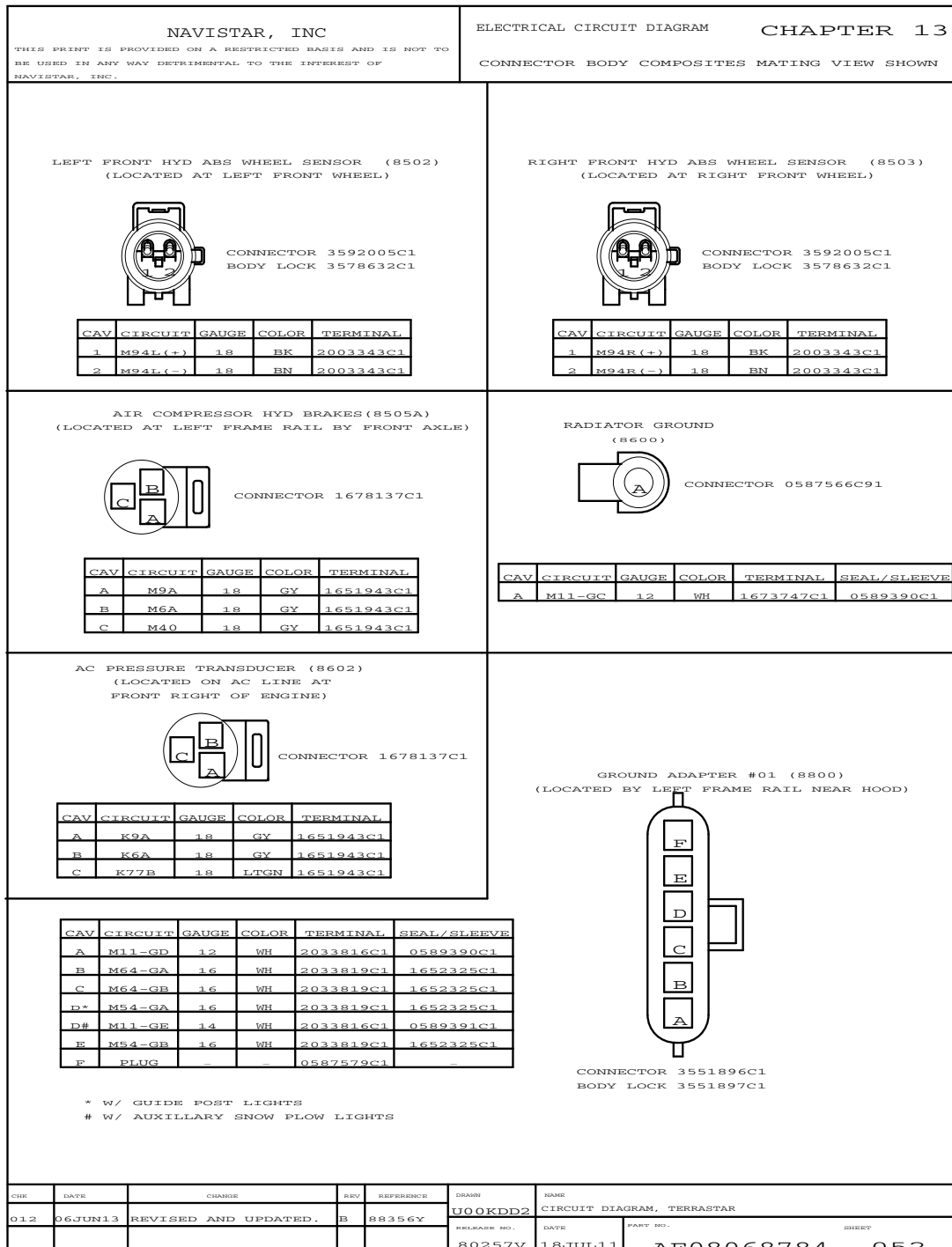

Figure 219 Connector Body Composites (8502 / 8503 / 8505A / 8600 / 8602 / 8800)

13.67. CONNECTOR BODY COMPOSITES (8805 / 8807 / 8881 / 8882), P. 53

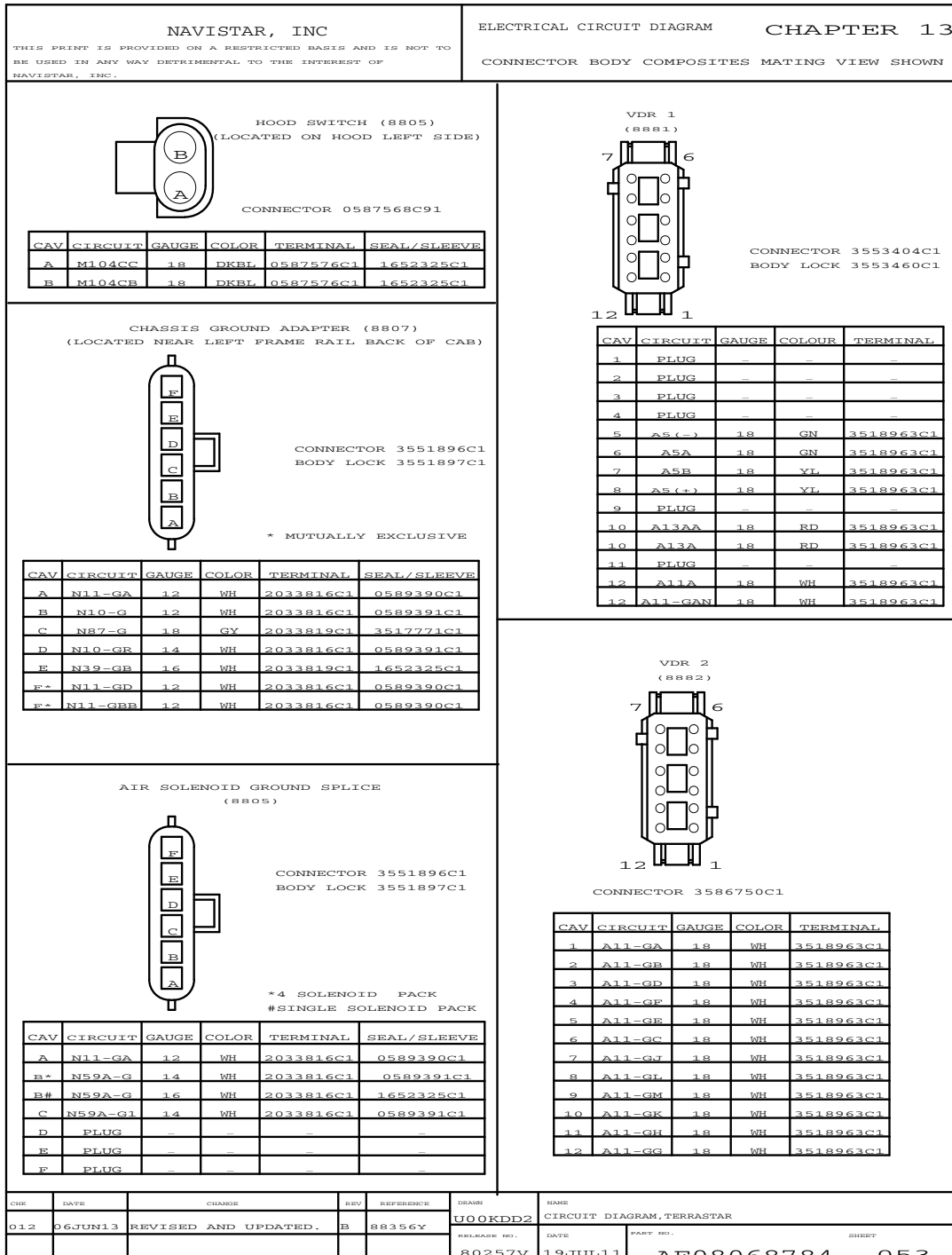

Figure 220 Connector Body Composites (8805 / 8807 / 8881 / 8882)

13.68. CONNECTOR BODY COMPOSITES (8883 / 8884A / 8884C), P. 53A

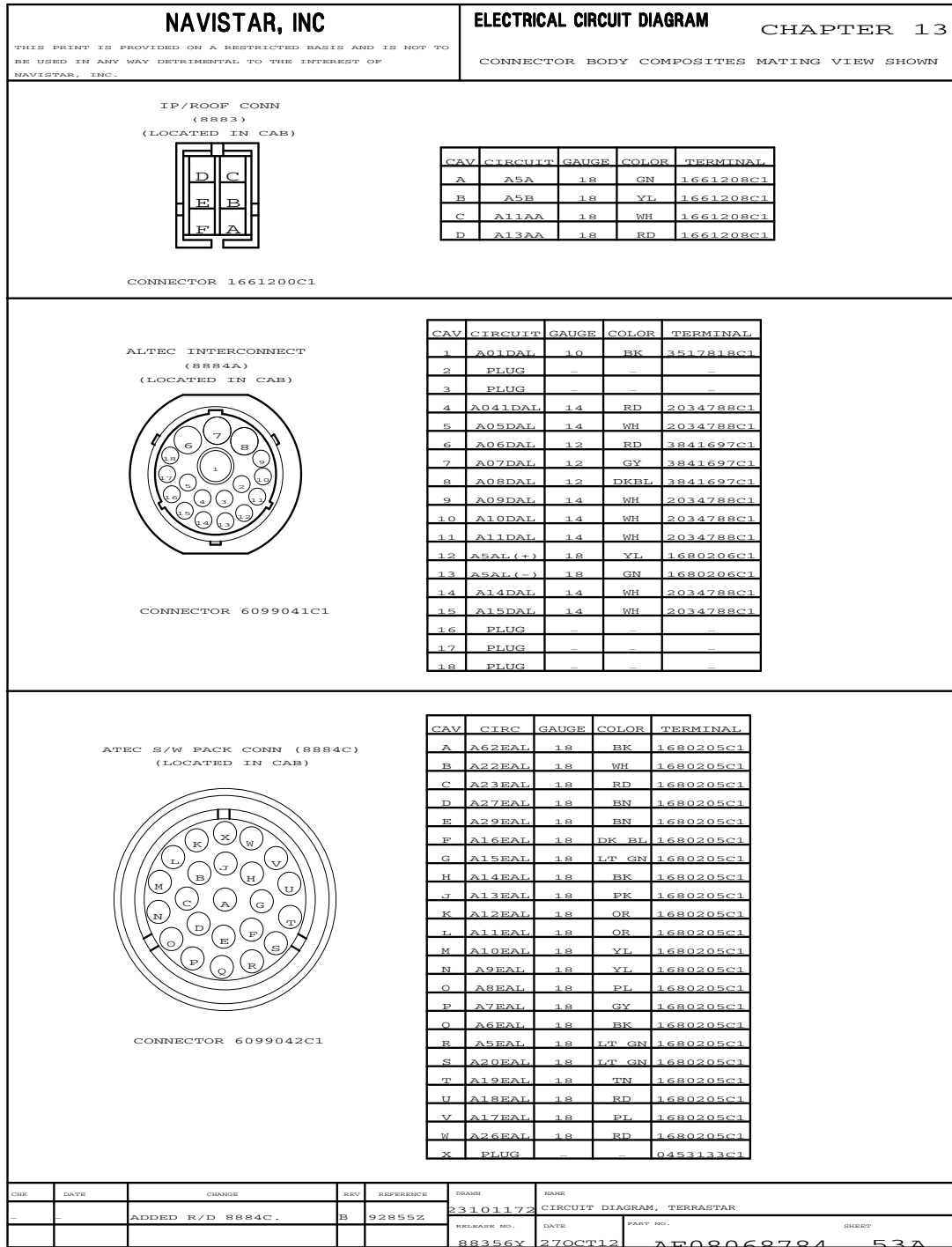

Figure 221 Connector Body Composites (8883 / 8884A / 8884C)

13.69. CONNECTOR BODY COMPOSITES (8995 / 8996), P. 53B

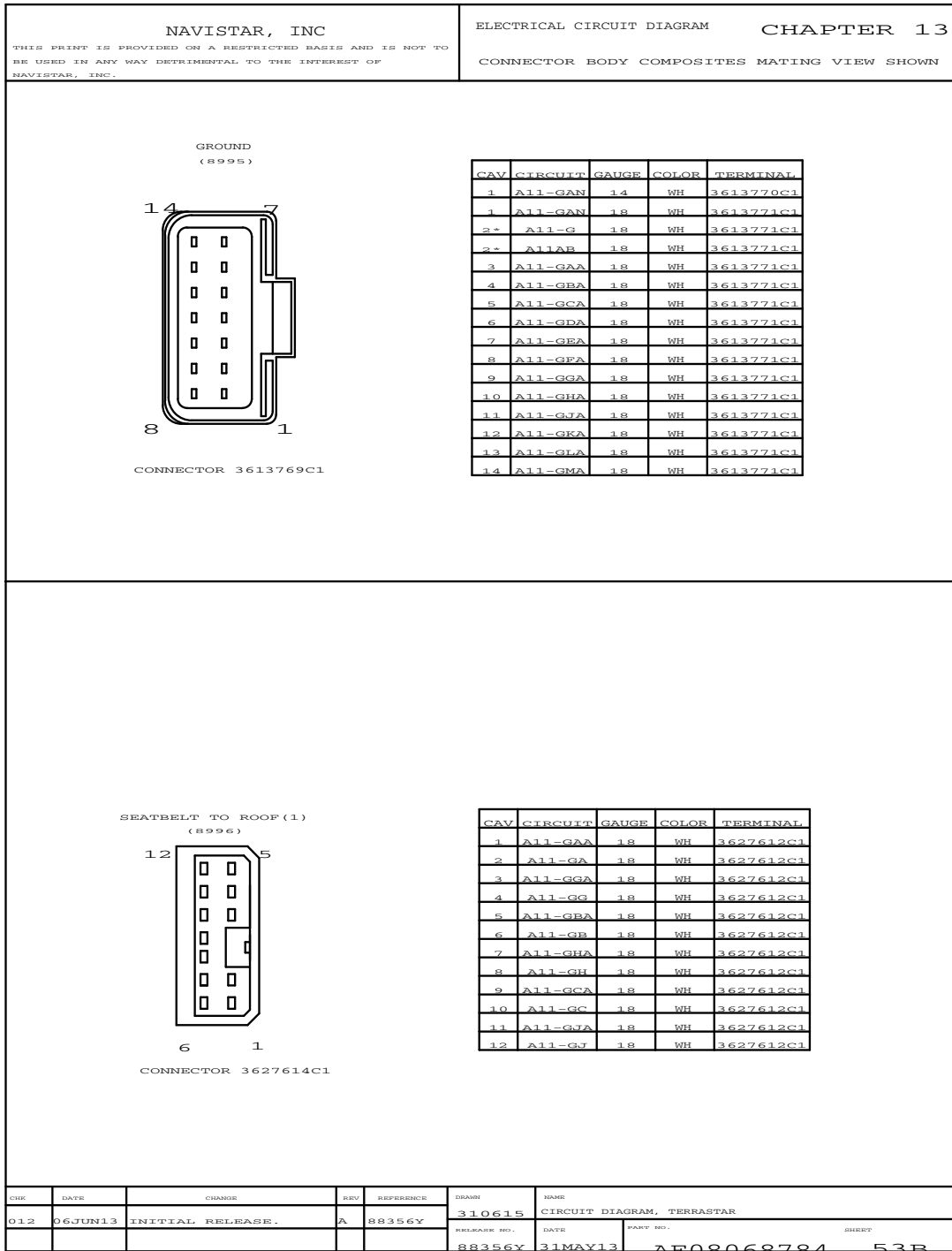

Figure 222 Connector Body Composites (8995 / 8996)

13.70. CONNECTOR BODY COMPOSITES (8997 / 8998 / 8999 / 9001), P. 54

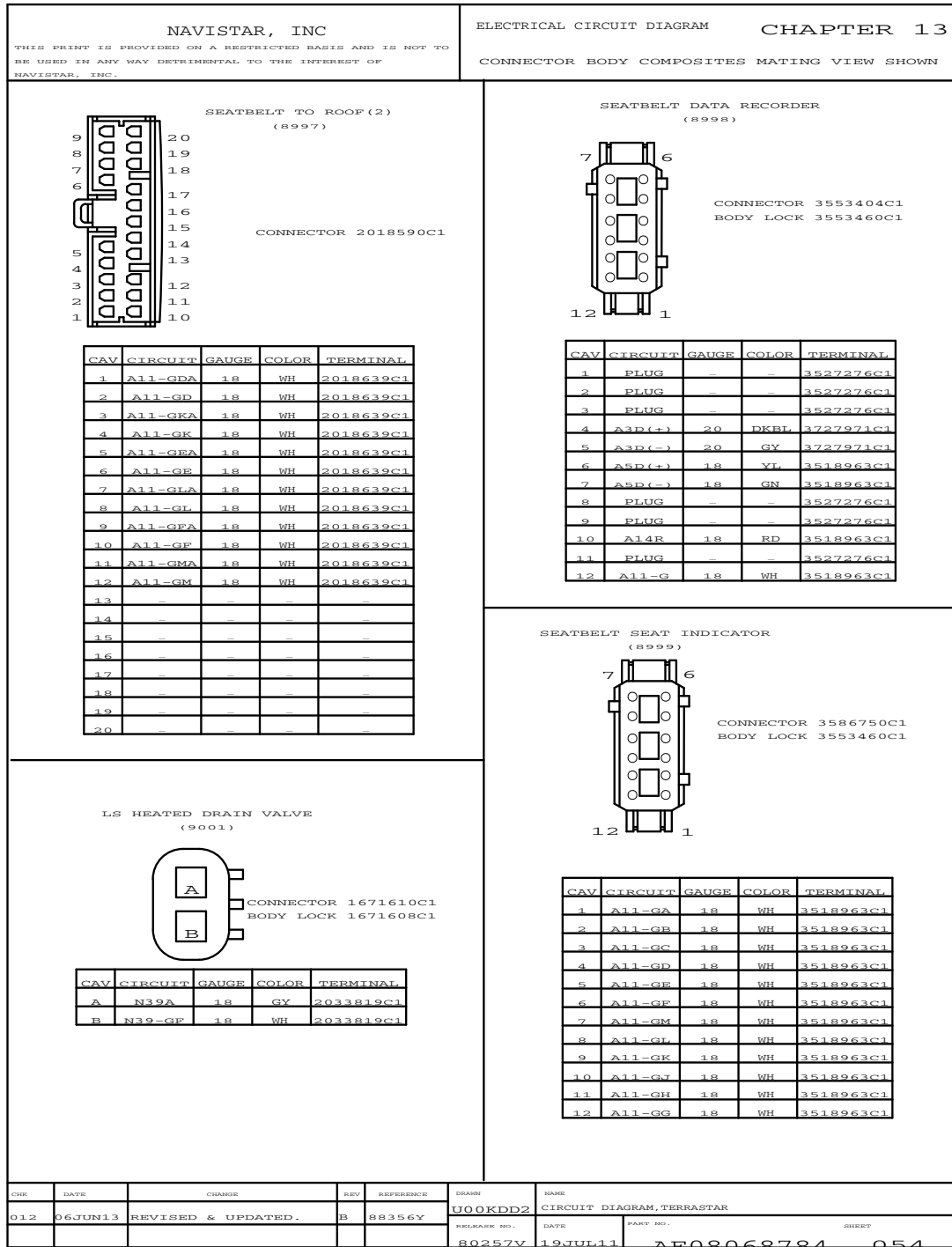

Figure 223 Connector Body Composites (8997 / 8998 / 8999 / 9001)

13.71. CONNECTOR BODY COMPOSITES (9100 / 9101 / 9101A / 9102 / 9260 / 9261), P. 55

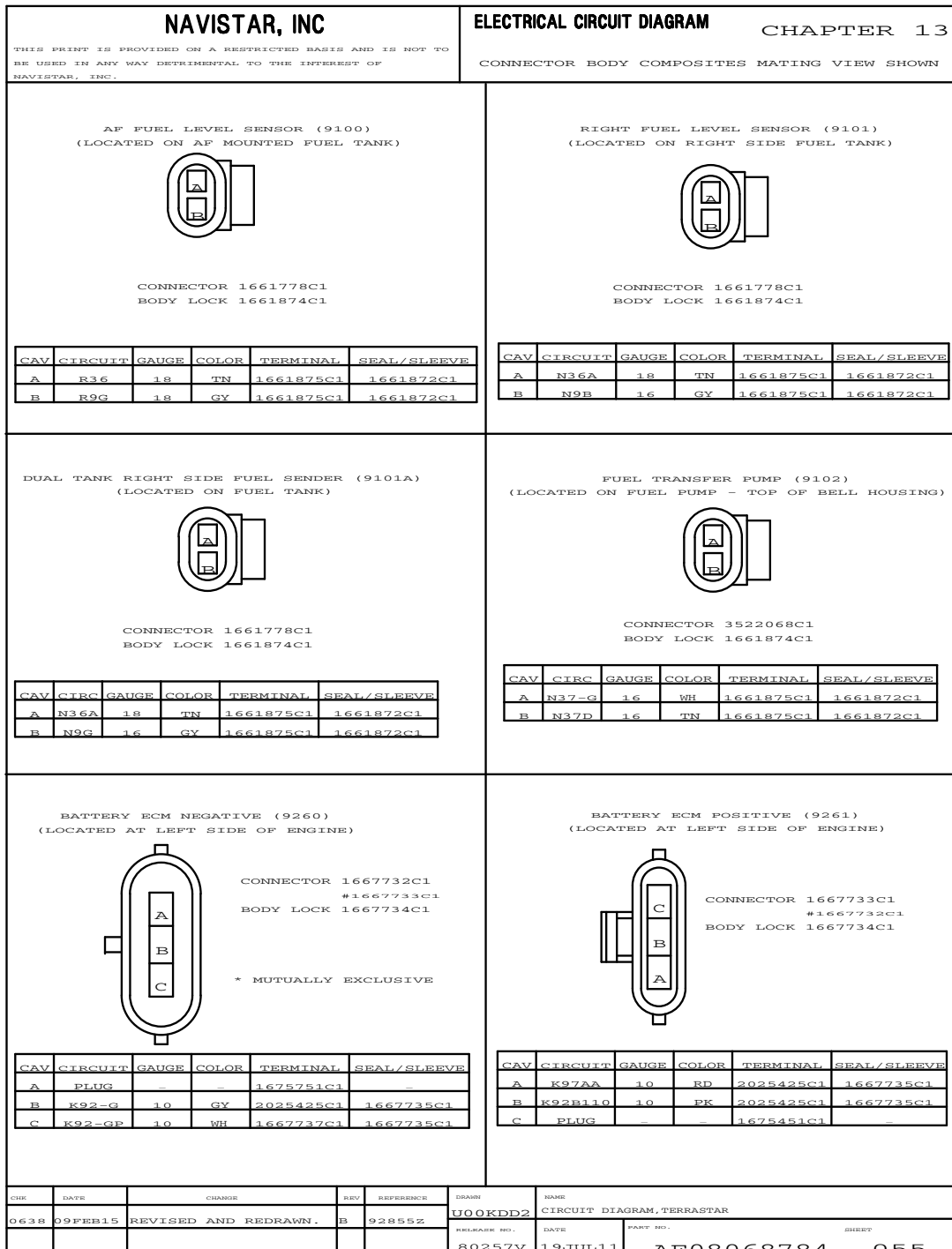

Figure 224 Connector Body Composites (9100 / 9101 / 9101A / 9102 / 9260 / 9261)

13.72. CONNECTOR BODY COMPOSITES (9511A / 9521 / 9522 / 9530), P. 56

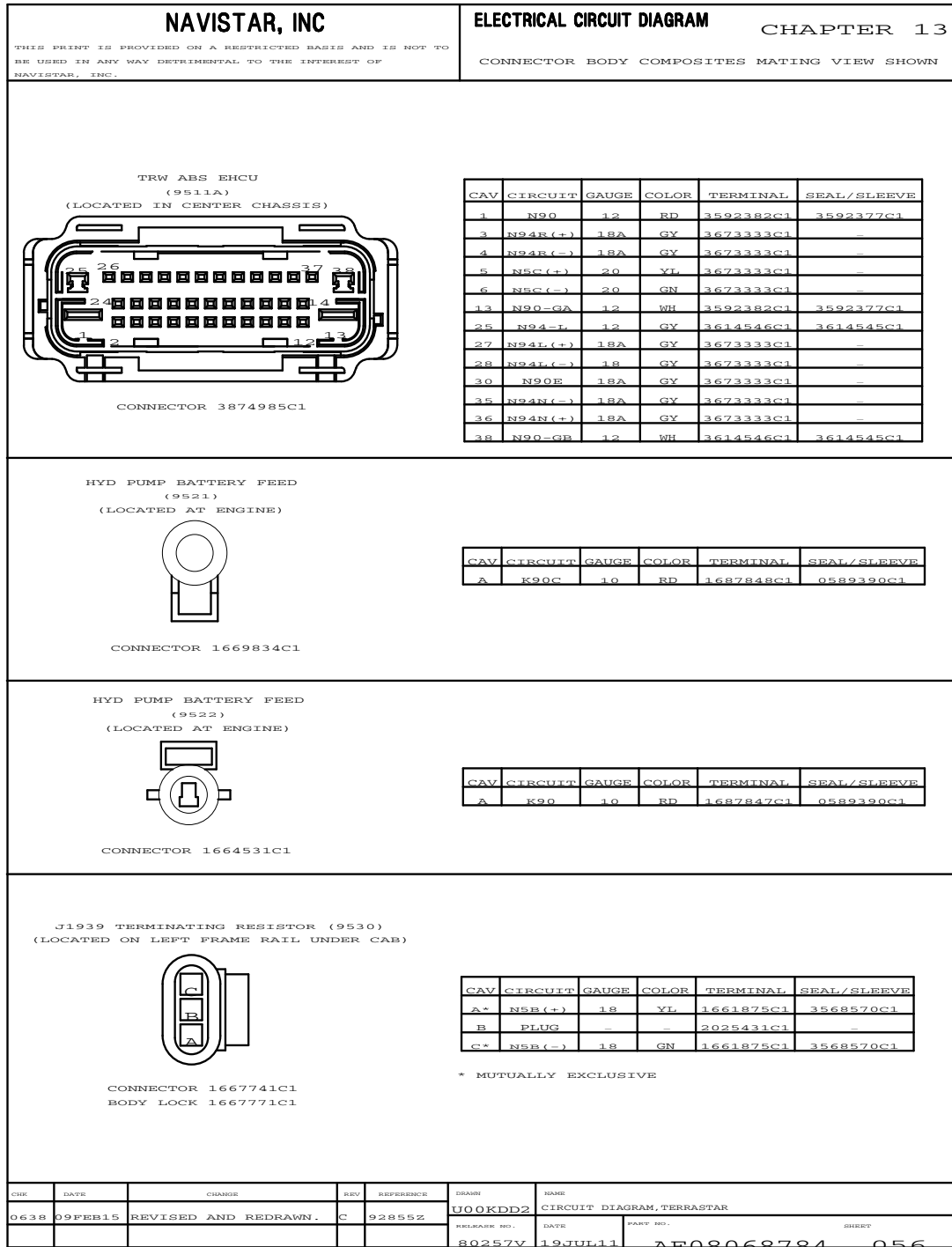

Figure 225 Connector Body Composites (9511A / 9521 / 9522 / 9530)

13.73. CONNECTOR BODY COMPOSITES (9715 / 9715F / 9716 / 9716M / 9717), P. 57

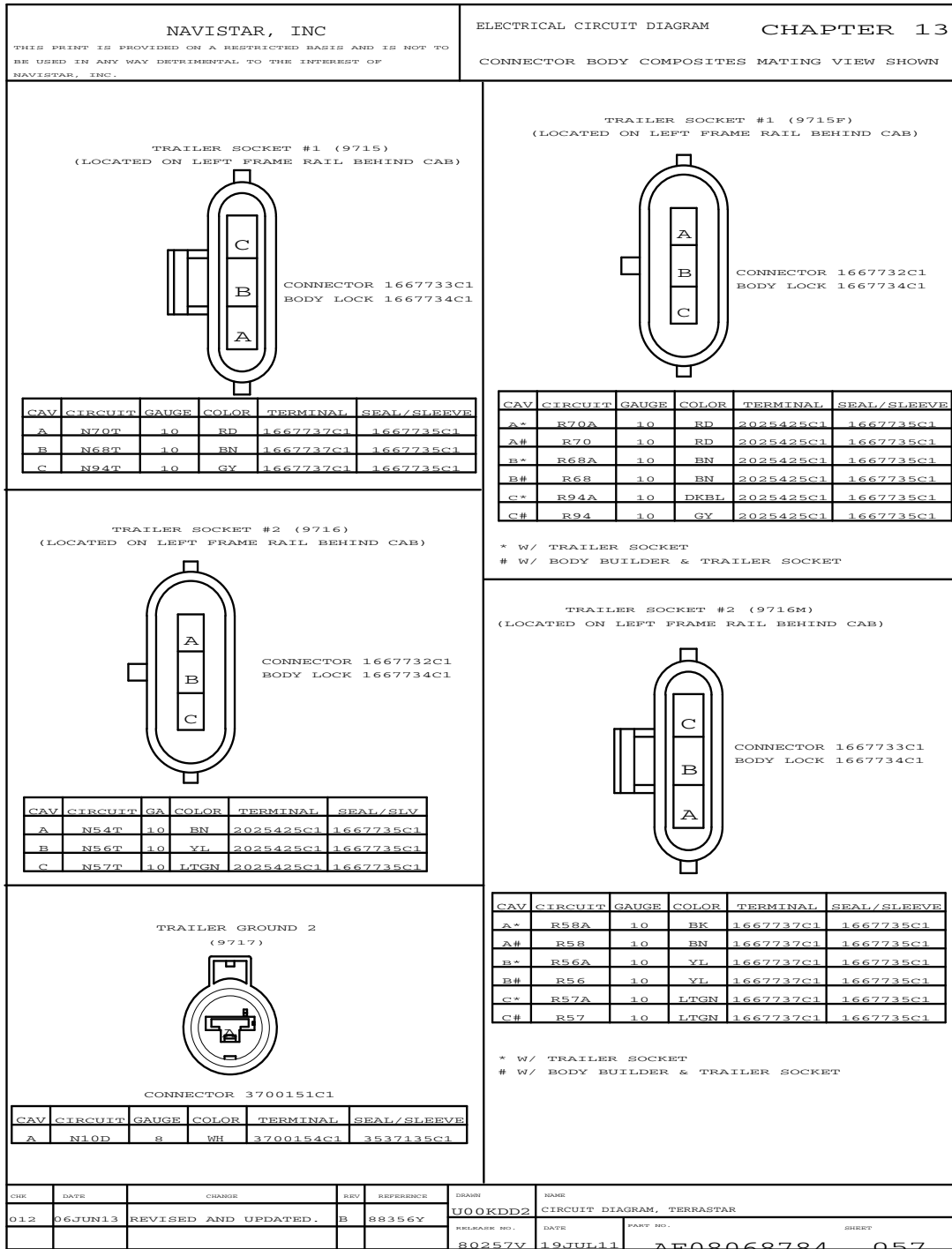

Figure 226 Connector Body Composites (9715 / 9715F / 9716 / 9716M / 9717)

13.74. CONNECTOR BODY COMPOSITES (9717 / 9717F / 9736 / 9737 / 9740), P. 58

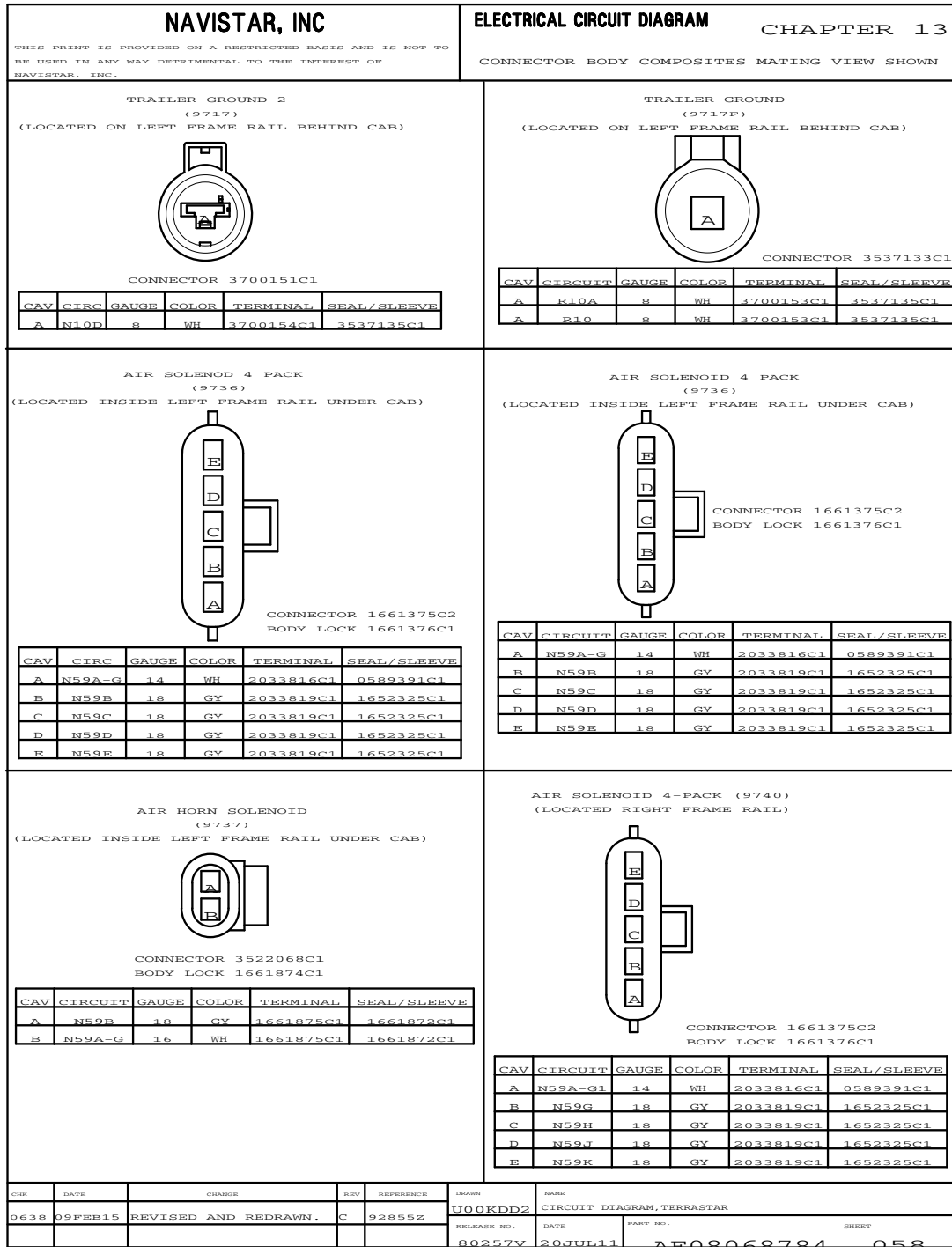

Figure 227 Connector Body Composites (9717 / 9717F / 9736 / 9737 / 9740)

13.75. CONNECTOR BODY COMPOSITES (9778 / 9778F / 9779F / 9780M), P. 58A

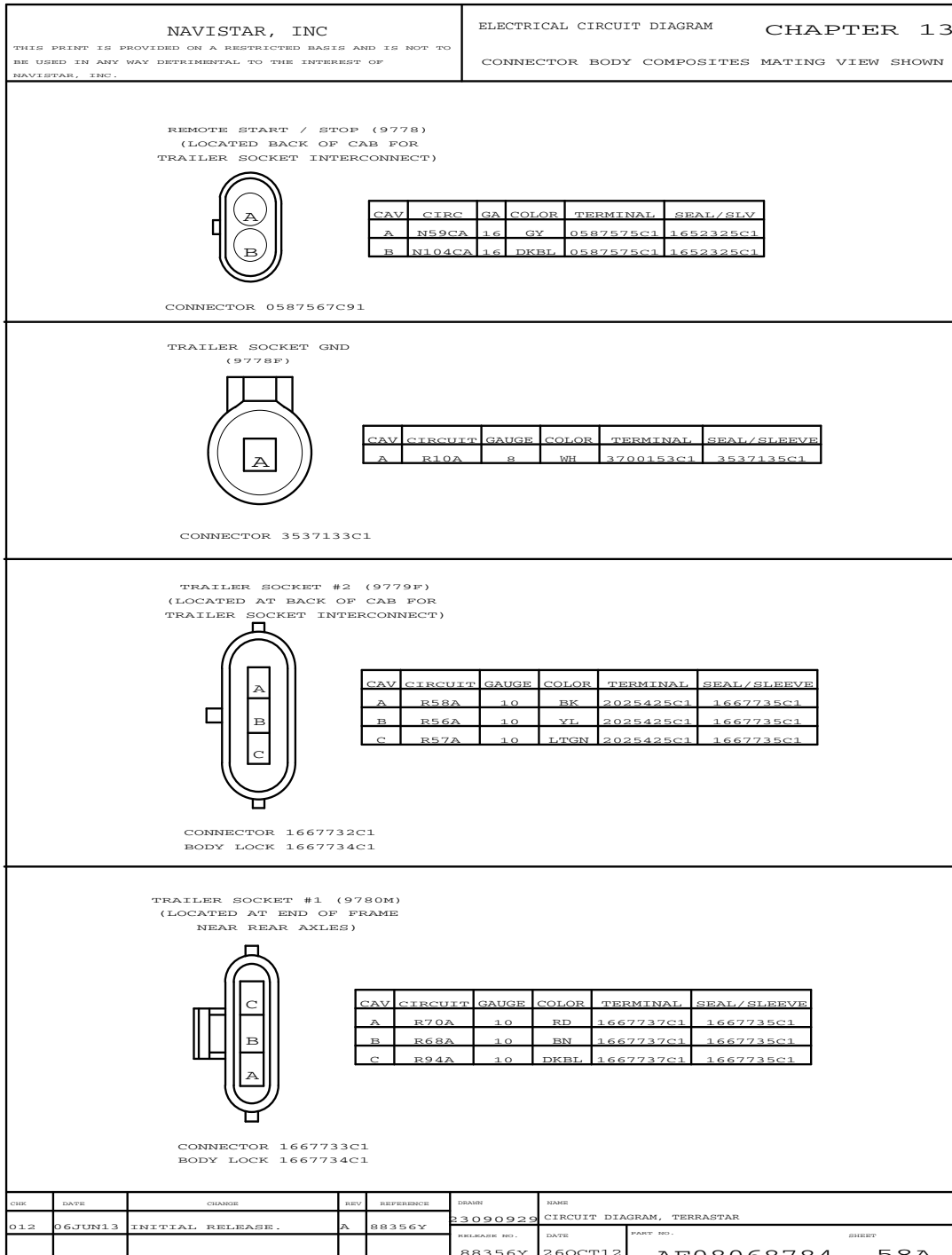

Figure 228 Connector Body Composites (9778 / 9778F / 9779F / 9780M)

13.76. CONNECTOR BODY COMPOSITES (9745 / 9746 / 9800), P. 59

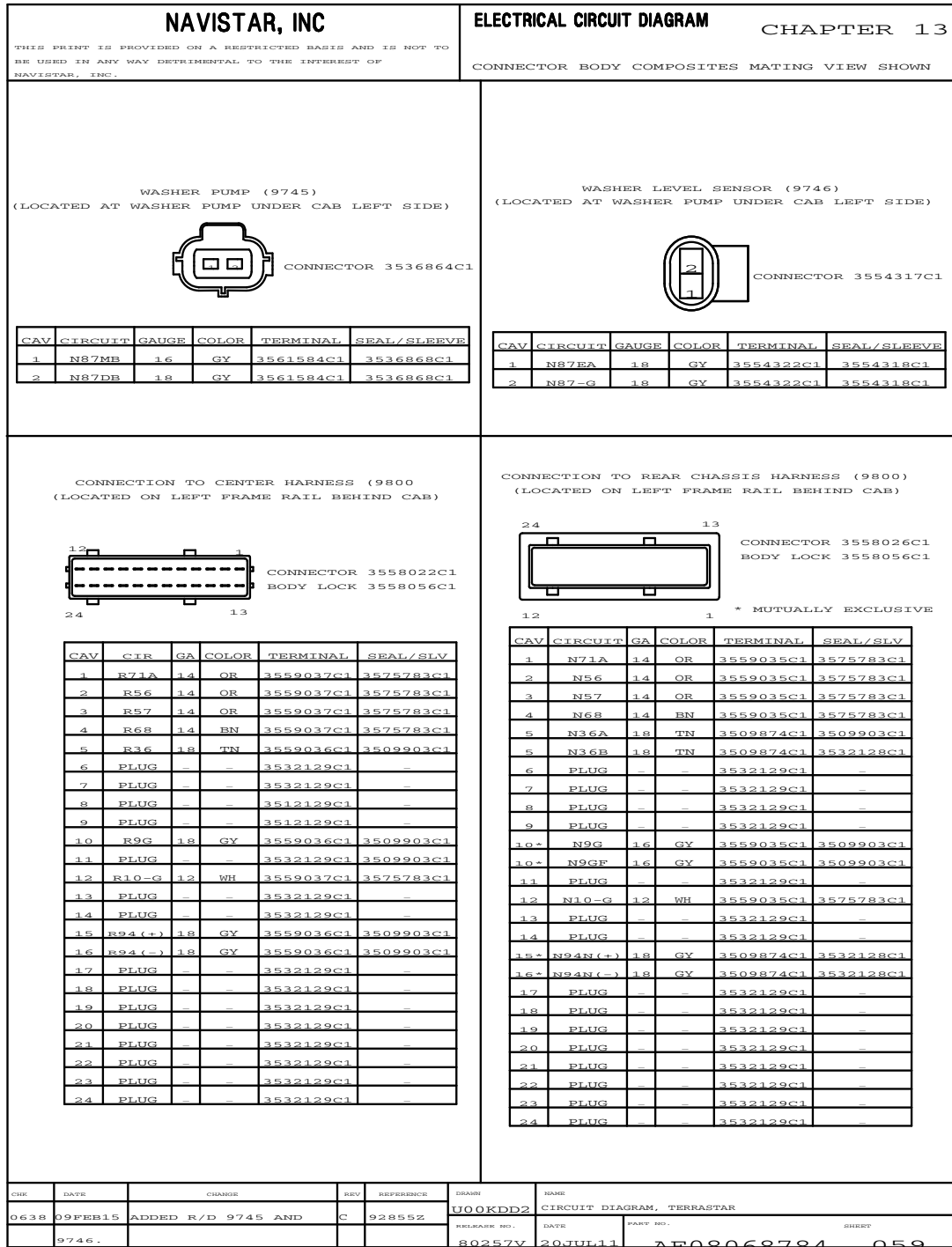

Figure 229 Connector Body Composites (9745 / 9746 / 9800)

13.77. CONNECTOR BODY COMPOSITES (9812 / 9900 / 9913B / 9915), P. 60

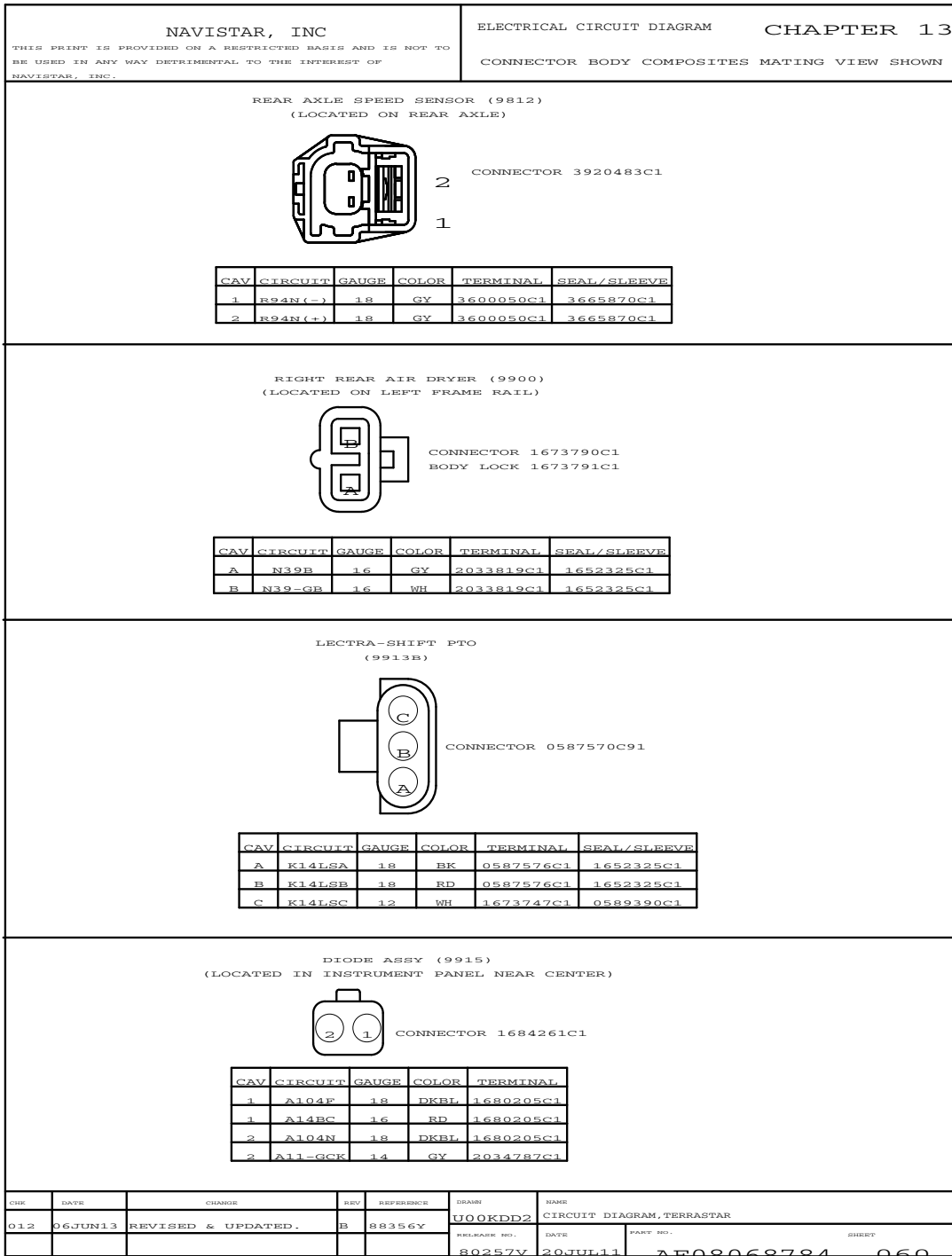

Figure 230 Connector Body Composites (9812 / 9900 / 9913B / 9915)

13.78. CONNECTOR BODY COMPOSITES (9916 / 9930 / 9994), P. 60A

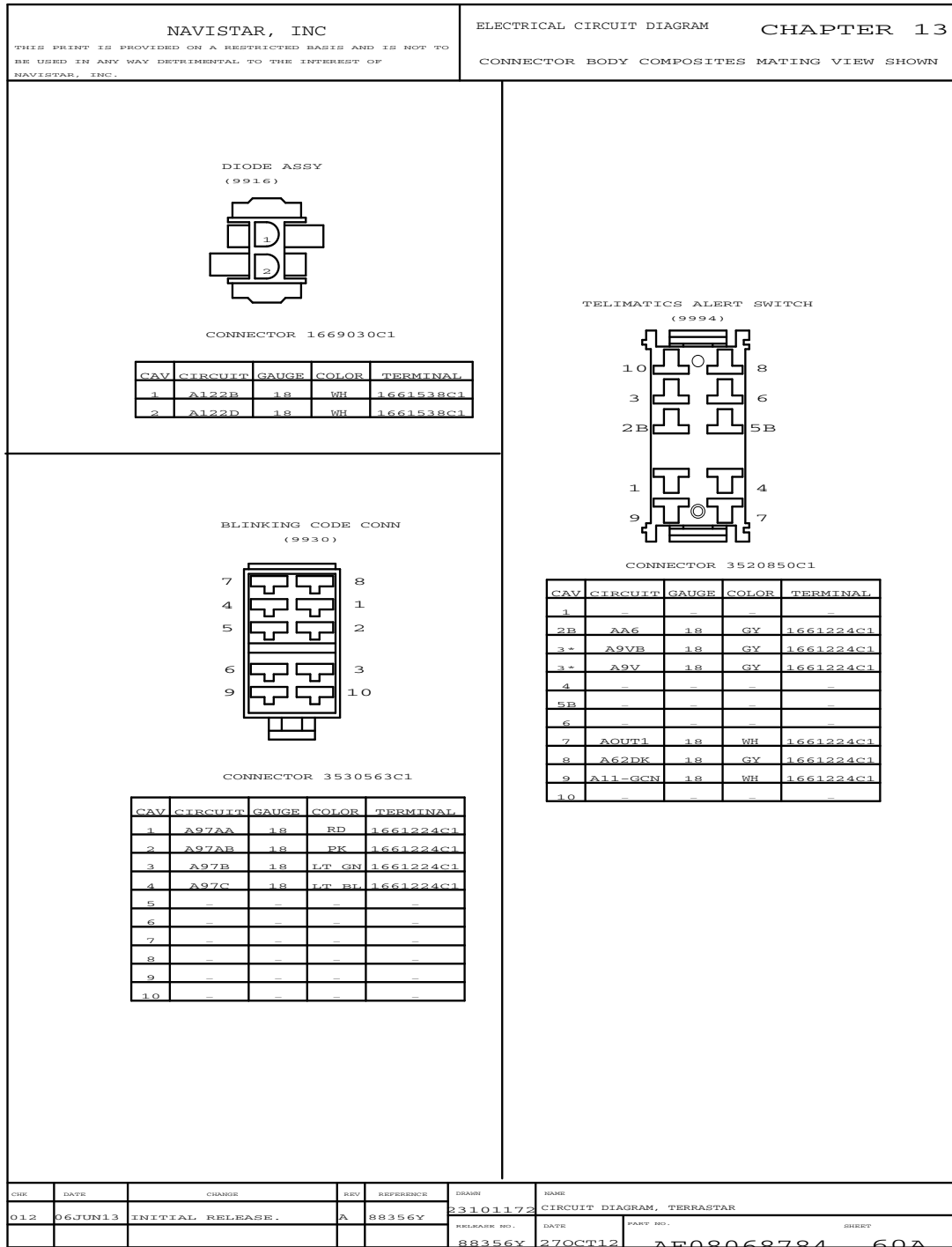

Figure 231 Connector Body Composites (9916 / 9930 / 9994)